

By E-filing

REF:TEIL:SE:

Date: 24th August, 2021

The Deputy General Manager Department of Corporate Services, BSE Limited, 1 st Floor, New Trading Ring, Rotunda Building, P.J. Tower, Dalal Street, Fort, MUMBAI – 400 001.	The Asst. Vice President, Listing Department National Stock Exchange of India Ltd., Exchange Plaza, 5th Floor, Plot No. C/1, G Block, Bandra-Kurla Complex, Bandra (E), MUMBAI - 400 051.
STOCK CODE: 532356	STOCK CODE: TRIVENI
Sub: Submission of Annual Report for FY 2020-21 along with Notice of 85th AGM of the Company	

Dear Sir/Madam,

Further to our letter dated August 20, 2021 and pursuant to Regulations 30 and 34 of the SEBI (LODR) Regulations, 2015, please find attached herewith the Annual Report of the Company for the FY 2020-21 ended on 31st March, 2021 along with Notice convening the 85th Annual General Meeting ("AGM") of the Company on **Friday, 17th September, 2021 at 3.00 P.M. (IST) through Video Conferencing (VC) / Other Audio Visual Means (OAVM).**

The said Annual Report and Notice of AGM are being dispatched electronically to those Members whose email IDs are registered with the Company/KFin Technologies Private Limited ("KFintech"), Registrar and Share Transfer Agent of the Company/the Depositories, and also being uploaded on the Company's website and can be accessed at www.trivenigroup.com.

The Company has appointed KFinTech for providing e-voting facility (remote e-voting and e-voting at the AGM). **The remote e-voting period commences on 14th September, 2021 at 10.00 A.M. (IST) and ends on 16th September, 2021 at 5.00 P.M. (IST).** The **cut-off date** for determining the eligibility of members for e-voting is **10th September, 2021.**

You are requested to please take the above on record.

Thanking you,

Yours faithfully,
For Triveni Engineering & Industries Ltd.,

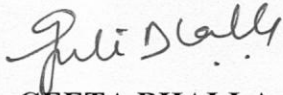

GEETA BHALLA
Group Vice President &
Company Secretary

Encl: As above

Copy to:

KFin Technologies Pvt. Limited Selenium Tower B, Plot No.31-32, Gachibowli, Financial District, Nanakramguda, Hyderabad-500032.	National Securities Depository Limited Trade World, A Wing, 4 th & 5 th Floor, Kamala Wing Compound, Lower Parel, Mumbai-400 013.	Central Depository Services (India) Limited Marathon Futurex, A-Wing, 25 th Floor, NM Joshi Marg, Lower Parel, Mumbai-400013.
---	---	--

NOTICE

NOTICE is hereby given that the 85th Annual General Meeting of Members of Triveni Engineering & Industries Limited will be held on **Friday, the 17th day of September, 2021 at 3.00 p.m. (IST)** through Video Conferencing (“VC”) / Other Audio Visual Means (“OAVM”) to transact the following business:

ORDINARY BUSINESS:

1. To receive, consider and adopt:
 - (a) the audited financial statements of the Company for the year ended March 31, 2021 including the audited Balance Sheet as at March 31, 2021 and the Statement of Profit and Loss for the year ended on that date together with the Reports of the Board of Directors and Auditors’ thereon; and
 - (b) the audited consolidated financial statements of the Company for the year ended March 31, 2021 including the audited consolidated Balance Sheet as at March 31, 2021 and the consolidated Statement of Profit and Loss for the year ended on that date together with the Report of the Auditors’ thereon.
2. To declare a dividend of Rs. 1.75 per fully paid equity share of Re. 1/- each for the financial year ended March 31, 2021.
3. To appoint a Director in place of Mr. Tarun Sawhney (Director Identification Number: 00382878), who retires by rotation and, being eligible, offers himself for re-appointment.

SPECIAL BUSINESS:

4. **To consider and, if thought fit, to pass with or without modification(s), the following resolution as an Ordinary Resolution:**

RESOLVED THAT pursuant to the provisions of Sections 149, 152 read with Schedule IV and other applicable provisions, if any, of the Companies Act, 2013 (‘the Act’) and the Rules made thereunder and the relevant provisions of Securities and Exchange Board of India (Listing Obligations and Disclosure Requirements), Regulations, 2015 (including any statutory modification(s) or re-enactment(s) thereof, for the time being in force), Mr Ajay Kumar Relan (DIN 00002632) who was appointed as an Additional Director (in the capacity of Non-Executive Independent Director) in terms of Section 161 of the Act by the Board of Directors, and in respect of whom the Company has received a notice in writing under Section 160 of the Act proposing his candidature for the office of Director, be and is hereby appointed as an Independent Director of the Company not liable to retire by rotation, to hold office for a period of five years with effect from 29th June, 2021 to 28th June, 2026.

RESOLVED FURTHER THAT the Board of Directors of the Company be and are hereby authorized to take all such steps and generally to do all such acts, deeds, things and matters as may be considered necessary, desirable or expedient for the purpose of giving effect to the above resolution.

5. **To consider and, if thought fit, to pass with or without modification(s), the following resolution as a Special Resolution:**

RESOLVED THAT pursuant to the provisions of Section 197 and other applicable provisions, if any, of the Companies Act, 2013 (‘the Act’) read with the Rules made thereunder (including any statutory modification(s) or re-enactment thereof, for the time being in force), consent of the Company be and is hereby accorded to the payment of remuneration by way of commission to all or any of the Directors of the Company (other than the Managing Directors and the Whole-time Directors) in accordance with and upto the limits specified under the provisions of Section 197 of the Act, computed in accordance with the provisions of Section 198 of the Act, for a period of five years from the financial year commencing April 1, 2021, in such proportion and in such manner and upto such extent as the Board of Directors may determine from time to time.

RESOLVED FURTHER THAT the Board of Directors of the Company be and are hereby authorized to take all such steps and generally to do all such acts, deeds, things and matters as may be considered necessary, desirable or expedient and to settle any question, difficulty or doubt that may arise for the purpose of giving effect to the above resolution.

6. **To consider and, if thought fit, to pass with or without modification(s), the following resolution as a Special Resolution:**

RESOLVED THAT pursuant to the provisions of Section 12 and other applicable provisions, if any, of the Companies Act, 2013 read with the Rules made thereunder (including any statutory modification(s) or re-enactment thereof, for the time being in force), consent of the members be and is hereby accorded for shifting the Registered Office of the Company from Deoband, District Saharanpur, Uttar Pradesh-247 554 to A-44, Hosiery Complex, Phase-II Extension, Noida-201 305 Uttar Pradesh.

RESOLVED FURTHER THAT the Board of Directors of the Company be and are hereby authorized to take all such steps and generally to do all such acts, deeds, things and matters as may be considered necessary, desirable or expedient and to settle any question, difficulty or doubt that may arise for the purpose of giving effect to the above resolution.

7. **To consider and, if thought fit, to pass with or without modification(s), the following resolution as an Ordinary Resolution:**

RESOLVED THAT pursuant to the provisions of Section 148 and other applicable provisions, if any, of the Companies Act, 2013 read with the Companies (Audit and Auditors) Rules, 2014 (including any statutory modification(s) or re-enactments thereof, for the time being in force), Mr Rishi Mohan Bansal, Cost Accountant (Firm Registration Number: 102056) and M/s GSR & Associates, Cost Accountants (Firm Registration Number: 000069) appointed as Cost Auditors by the Board of Directors of the Company, to conduct the audit of the cost records of the Company's sugar businesses (including cogeneration and distillery) and power transmission business respectively for the financial year ending March 31, 2022, be paid the remuneration as set out in the Explanatory Statement annexed to the Notice convening this Meeting.

RESOLVED FURTHER THAT the Board of Directors of the Company be and are hereby authorized to take all such steps and generally to do all such acts, deeds, things and matters as may be considered necessary, desirable or expedient and to settle any question, difficulty or doubt that may arise for the purpose of giving effect to the above resolution.

By Order of the Board

Geeta Bhalla
Group Vice President &
Company Secretary
M.No.9475

Date : August 14, 2021

Place: Noida

NOTES:

1. In view of the continuation of the COVID-19 pandemic and the consequent social distancing norms to be followed, the Ministry of Corporate Affairs ("MCA") has issued Circular No. 14/2020 dated April 08, 2020, Circular No.17/2020 dated April 13, 2020, Circular No. 20/2020 dated May 05, 2020 and Circular No. 02/2021 dated January 13, 2021 (hereinafter collectively referred to as the "MCA Circulars"). Pursuant to the MCA Circulars, physical attendance of the members at the Annual General Meeting ('AGM') venue is not required and AGM can be held through Video Conferencing ("VC") or Other Audio Visual Means ("OAVM"). Hence, in compliance with the MCA Circulars, members can attend and participate and vote in the ensuing AGM through VC/OAVM.
2. The above MCA Circulars read with the Securities and Exchange Board of India ("SEBI") Circular No. SEBI/HO/CFD/CMD1/CIR/P/2020/79 dated May 12, 2020 and SEBI/HO/CFD/CMD2/CIR/P/2021/11 dated January 15, 2021 ("SEBI Circulars") also temporarily dispense with the requirement of sending the physical copies of the AGM Notice and Annual Report to the members. Accordingly, this Notice of the AGM along with the Annual Report 2020-21 are being sent only through electronic mode to those members whose e-mail addresses are registered with the Company's Registrar and Transfer Agent/ Depository Participant.
3. Since this AGM will be held through Video Conferencing ('VC') / Other Audio Visual Means ('OAVM'), Members will not be able to appoint proxies for the meeting, and (b) Attendance Slip & Route Map are not being annexed to this Notice.
4. An Explanatory Statement, pursuant to Section 102 of the Companies Act, 2013 ('the Act'), relating to the Special Business to be transacted at this AGM, and the relevant details pursuant to Regulation 36(3) of the SEBI (LODR) Regulations, 2015 ('Listing Regulations') and Secretarial Standards on General Meeting in respect of Directors seeking appointments at the AGM are annexed hereto and forms part of this notice.
5. The **Record Date** fixed for the purpose of determining entitlement of the members to the dividend for the financial year ended March 31, 2021 is **Friday, September 10, 2021**, and such dividend, if declared at the AGM, will be paid within 30 days from the conclusion of the AGM to those members entitled thereto.
6. Pursuant to the Income-tax Act, 1961, as amended, dividend income is taxable in the hands of the members and the Company is required to deduct tax at source (TDS) from such dividend at the prescribed rates. A communication providing information and detailed instructions with respect to tax on dividend ("**TDS Instructions on Dividend Distribution**") for the financial year ended 31st March, 2021 is being sent to the members through email along with notice of AGM and Annual Report for FY21 and the same is also available on the website of the Company www.trivenigroup.com.
7. Members wishing to claim dividends that remain unclaimed are requested to correspond with the Company's Share Department or its RTA, KFin Technologies Private Limited ('KFinTech') at shares@trivenigroup.com / inward.ris@kfintech.com. Members are requested to note that dividends which are not claimed within seven years from the date of transfer to the Company's Unpaid Dividend Account, will be transferred to the Investor Education and Protection Fund ('IEPF'). Shares on which dividend remains unclaimed for seven consecutive years shall also be transferred to the IEPF as per Section 124 of the Act, read with applicable IEPF rules.
8. In the event of transfer of shares and the unclaimed dividend to IEPF, members are entitled to claim the same from the IEPF Authority by submitting an online application in the prescribed Form IEPF-5 available on the website www.iepf.gov.in and sending a physical copy of the same duly signed to the Company along with the requisite documents enumerated in Form IEPF-5. The status of dividends remaining unpaid/ unclaimed along with the respective due dates of transfer to IEPF is provided in the Annual Report.
9. SEBI has mandated submission of Permanent Account Number ("PAN") by every participant in the securities market. Members holding shares in demat form are therefore, requested to submit PAN details to the Depository Participant(s) with whom they have demat accounts. Members holding shares in physical form can submit their PAN details to KFinTech, RTA of the Company.

10. As per Regulation 40 of the Listing Regulations, as amended, securities of listed companies can be transferred only in dematerialized form with effect from April 1, 2019, except in case of requests received for transmission or transposition of securities. In view of the above and the inherent benefits of holding shares in electronic form, the Company urge the members holding shares in physical form to opt for dematerialization.
11. Members holding shares in single name are advised to make nomination in respect of their shareholding in the Company. The prescribed Nomination Form can be obtained, in case of shares held in physical form from KFintech, RTA or the Share Department of the Company, and in case of shares held in demat form, from their respective Depository Participant(s).
12. In order to timely receive Notice, Annual Report and dividend, members holding equity shares in physical form are requested to register/update their email address and bank mandates by emailing a scan copy of signed request letter quoting their folio number and providing details of their email address and bank mandates along with scan copies of self-attested copy of PAN card and cancelled cheque leaf bearing the name of the member, to the Company/RTA at shares@trivenigroup.com / einward.ris@kfintech.com.

Members holding equity shares in dematerialized form are requested to register/update the aforesaid details directly to their respective Depository Participant(s) ("DP").

13. The Register of Directors and Key Managerial Personnel and their shareholding under Section 170 of the Act, and the Register of Contracts or Arrangements in which the directors are interested under Section 189 of the Act, will remain available for inspection through electronic mode during the AGM, for which purpose Members are required to send an e-mail to the Company Secretary at shares@trivenigroup.com.

Dispatch of Annual Report:

14. In view of the prevailing circumstances due to the COVID-19 pandemic, and also in conformity with the applicable regulatory requirements, the Notice of this AGM and the Annual Report for FY 21 are being sent only through electronic mode to those Members who have registered their e-mail addresses with the Company or with the Depositories. Members may note that the Notice and Annual Report FY21 will also be available on the Company's website www.trivenigroup.com, websites of the stock exchanges i.e. BSE Limited ('BSE') and National Stock Exchange of India Limited ('NSE') at www.bseindia.com and www.nseindia.com respectively and on the website of KFintech at <https://evoting/kfintech.com>.

Procedure and Instructions for Remote E-Voting and E-voting (insta-poll) at the AGM and for joining the AGM through VC/OAVM

15. In terms of Section 108 of the Act read with Rule 20 of the Companies (Management and Administration) Rules, 2014 and Regulation 44 of the Listing Regulations, as amended, the Resolutions for consideration at the AGM will be transacted through remote e-voting (i.e. facility to cast vote prior to the AGM) and also e-voting (insta-poll) during the AGM, for which purpose the Company has engaged the services of KFintech. The Board of Directors has appointed Mr Suresh Gupta, practising company secretary (FCS 5660/CP No.5204) as a Scrutinizer to scrutinize the process of e-voting.
16. Voting rights will be reckoned on the paid-up value of shares registered in the name of the Members on **Friday, September 10, 2021 (cut-off date)**. Only those Members whose names are recorded in the Register of Members of the Company or in the Register of Beneficial Owners maintained by the Depositories as on the cut-off date will be entitled to cast their votes by remote e-voting or e-voting during the AGM. Those who are not Members on the cut-off date should accordingly treat this Notice as for information purposes only.
17. The **remote e-voting period commences on Tuesday, September 14, 2021 at 10.00 A.M (IST) and ends on Thursday, September 16, 2021 at 05.00 P.M. (IST)** when remote e-voting will be blocked by KFintech.
Once the vote on the resolution is cast by the member, the member shall not be allowed to change it subsequently or cast the vote again. However, those members who will be present in the AGM through VC/OAVM facility and have not cast their vote on the resolutions during the remote e-voting period and are otherwise not barred from doing so, shall be eligible to vote through e-voting system during the AGM.
18. Any person who becomes a member of the Company after the dispatch of Notice of AGM and holding shares as on the cut-off date, may obtain the login ID and password by sending a request at evoting@kfintech.com. However, if he / she is already registered with KFintech for remote e-voting then he /she can use his / her existing User ID and password for casting the vote. If the member has forgotten his/her password, he/she may reset his/her password by using "Forgot User Details/ Password" option available on <http://evoting.kfintech.com>.
19. As per SEBI circular no. SEBI/HO/CFD/CMD/CIR/P/2020/242 dated December 9, 2020 on "e-Voting facility provided by Listed Companies", e-Voting process has been enabled to all the **individual demat account holders**, by way of single login credential, through their demat accounts / websites of Depositories / DPs in order to increase the efficiency of the voting process. Members are advised to update their mobile number and e-mail ID with their DPs to access e-Voting facility.
20. Individual demat account holders would be able to cast their vote without having to register again with the e-Voting service provider (ESP) thereby not only facilitating seamless authentication but also ease and convenience of participating in e-Voting process.

21. The process and manner for remote e-voting and e-voting (insta-poll) during AGM are explained herein below:

(I) Login method for remote e-voting for individual shareholders holding securities in demat mode through Depositories e-voting system.

Type of shareholders	Login Method
Individual Shareholders holding securities in demat mode with NSDL	<ol style="list-style-type: none"> 1. User already registered for IDeAS facility: <ol style="list-style-type: none"> I. Visit URL: https://eservices.nSDL.com II. Click on the "Beneficial Owner" icon under "Login" under 'IDeAS' section. III. On the new page, enter User ID and Password. Post successful authentication, click on "Access to e-Voting" IV. Click on company name or e-Voting service provider and you will be re-directed to e-Voting service provider website for casting the vote during the remote e-Voting period. 2. User not registered for IDeAS e-Services <ol style="list-style-type: none"> I. To register click on link : https://eservices.nSDL.com II. Select "Register Online for IDeAS" or click at https://eservices.nSDL.com/SecureWeb/IdeasDirectReg.jsp III. Proceed with completing the required fields. IV. Follow steps given in points 1. 3. Alternatively by directly accessing the e-Voting website of NSDL <ol style="list-style-type: none"> I. Open URL: https://www.evoting.nSDL.com/ II. Click on the icon "Login" which is available under 'Shareholder/Member' section. III. A new screen will open. You will have to enter your User ID (i.e. your sixteen digit demat account number held with NSDL), Password / OTP and a Verification Code as shown on the screen. IV. Post successful authentication, you will requested to select the name of the company and the e-Voting Service Provider name, i.e.KFintech. V. On successful selection, you will be redirected to KFintech e-Voting page for casting your vote during the remote e-Voting period.
Individual Shareholders holding securities in demat mode with CDSL	<ol style="list-style-type: none"> 1. Existing user who have opted for Easi / Easiest <ol style="list-style-type: none"> I. Visit URL: https://web.cdslindia.com/myeasi/home/login or URL: www.cdslindia.com II. Click on New System Myeasi III. Login with your registered user id and password. IV. The user will see the e-Voting Menu. The Menu will have links of ESP i.e. KFintech e-Voting portal. V. Click on e-Voting service provider name to cast your vote. 2. User not registered for Easi/Easiest <ol style="list-style-type: none"> I. Option to register is available at https://web.cdslindia.com/myeasi/Registration/EasiRegistration II. Proceed with completing the required fields. III. Follow the steps given in point 1 3. Alternatively, by directly accessing the e-Voting website of CDSL <ol style="list-style-type: none"> I. Visit URL: www.cdslindia.com II. Provide your demat Account Number and PAN No. III. System will authenticate user by sending OTP on registered Mobile & Email as recorded in the demat Account. IV. After successful authentication, user will be provided links for the respective ESP, i.e KFintech where the e- Voting is in progress.
Individual Shareholder login through their demat accounts / Website of Depository Participant	<ol style="list-style-type: none"> I. You can also login using the login credentials of your demat account through your DP registered with NSDL /CDSL for e-Voting facility. II. Once logged-in, you will be able to see e-Voting option. Once you click on e-Voting option, you will be redirected to NSDL / CDSL Depository site after successful authentication, wherein you can see e-Voting feature. III. Click on options available against company name or e-Voting service provider - Kfintech and you will be redirected to e-Voting website of KFintech for casting your vote during the remote e-Voting period without any further authentication.

Important note: Members who are unable to retrieve User ID / Password are advised to use Forgot user ID and Forgot Password option available at respective websites.

Helpdesk for Individual Shareholders holding securities in demat mode for any technical issues related to login through Depository i.e. NSDL and CDSL.

Login type	Helpdesk details
Securities held with NSDL	Please contact NSDL helpdesk by sending a request at evoting@nsdl.co.in or call at toll free no.: 1800 1020 990 and 1800 22 44 30
Securities held with CDSL	Please contact CDSL helpdesk by sending a request at helpdesk.evoting@cdslindia.com or contact at 022-23058738 or 022-23058542-43

(II) Login method for remote e-voting for shareholders other than individual shareholders holding securities in demat mode and shareholders holding securities in physical mode.

(A) Members whose email IDs are registered with the Company/ Depository Participants (s), will receive an email from KFintech which will include details of E-Voting Event Number (EVEN), USER ID and password. They will have to follow the following process:

- i. Launch internet browser by typing the URL: <https://evoting.kfintech.com/>
- ii. Enter the login credentials (i.e. User ID and password). In case of physical folio, User ID will be EVEN (E-Voting Event Number) xxxx, followed by folio number. In case of Demat account, User ID will be your DP ID and Client ID. However, if you are already registered with KFintech for e-voting, you can use your existing User ID and password for casting the vote.
- iii. After entering these details appropriately, click on "LOGIN".
- iv. You will now reach password change Menu wherein you are required to mandatorily change your password. The new password shall comprise of minimum 8 characters with at least one upper case (A- Z), one lower case (a-z), one numeric value (0-9) and a special character (@,#,\$, etc.). The system will prompt you to change your password and update your contact details like mobile number, email ID etc. on first login. You may also enter a secret question and answer of your choice to retrieve your password in case you forget it. It is strongly recommended that you do not share your password with any other person and that you take utmost care to keep your password confidential.
- v. You need to login again with the new credentials.
- vi. On successful login, the system will prompt you to select the "EVEN" i.e., "Triveni Engineering & Industries Limited AGM" and click on "Submit"
- vii. On the voting page, enter the number of shares (which represents the number of votes) as on the Cut-off Date under "FOR/AGAINST" or alternatively, you may partially enter any number in "FOR" and partially "AGAINST" but the total number in "FOR/AGAINST" taken together shall not exceed your total shareholding as mentioned herein above. You may also choose the option ABSTAIN. If the Member does not indicate either "FOR" or "AGAINST" it will be treated as "ABSTAIN" and the shares held will not be counted under either head.
- viii. Members holding multiple folios/demat accounts shall choose the voting process separately for each folio/ demat accounts.
- ix. Voting has to be done for each item of the notice separately. In case you do not desire to cast your vote on any specific item, it will be treated as abstained.
- x. You may then cast your vote by selecting an appropriate option and click on "Submit".
- xi. A confirmation box will be displayed. Click "OK" to confirm else "CANCEL" to modify. Once you have voted on the resolution (s), you will not be allowed to modify your vote. During the voting period, Members can login any number of times till they have voted on the Resolution(s).
- xii. Corporate/Institutional Members (i.e. other than Individuals, HUF, NRI etc.) are also required to send scanned certified true copy (PDF Format) of the Board Resolution/Authority Letter etc., authorizing its representative to attend the AGM through VC / OAVM on its behalf and to cast its vote through remote e-voting together with attested specimen signature(s) of the duly authorised representative(s), to the Scrutinizer at email id sureshguptacs@gmail.com with a copy marked to evoting@kfintech.com. The scanned image of the above-mentioned documents should be in the naming format "Corporate Name_Even No."

(B) Members whose email IDs are not registered with the Company/RTA/Depository Participants(s), will have to follow the following process:

- i. Members who have not registered their email address and consequently the Annual Report, Notice of AGM and e-voting instructions cannot be served, may temporarily get their email address and mobile number registered with KFintech, by accessing the link: <https://ris.kfintech.com/clientservices/mobilereg/mobileemailreg.aspx>. Members are requested to follow the process as guided to capture the email address and mobile number for sending the soft copy of the notice and e-voting instructions along with the User ID and Password. In case of any queries, member may write to einward.ris@kfintech.com.

- ii. Alternatively, member may send an e-mail request at the email id einward.ris@kfintech.com along with a scan copy of the signed request letter providing the email address, mobile number, self-attested PAN copy and Client Master copy in case of electronic folio (demat) and copy of share certificate in case of physical folio for sending the Annual report, Notice of AGM and the e-voting instructions.
- iii. After receiving the e-voting instructions, please follow all steps above to cast your vote by electronic means.
- iv. In case of any query and/or grievance, in respect of voting by electronic means, members may refer to the Help & Frequently Asked Questions (FAQs) and E-voting user manual available at the download section of <https://evoting.kfintech.com> (KFintech Website) or contact Ms C. Shobha Anand, Deputy General Manager at evoting@kfintech.com or call KFintech's toll free No. 1800-309-4001 for any further clarifications.

(III) Login method for all the shareholders for joining the AGM through VC/OAVM and e-voting (insta-poll) during the meeting

- i. Member will be provided with a facility to attend the AGM through VC / OAVM platform provided by KFintech. Members may access the same at <https://emeetings.kfintech.com> Members are requested to follow the procedure given below:
 - a) Launch internet browser (chrome/ firefox/safari) by typing the URL:<https://emeetings.kfintech.com>
 - b) Enter the login credentials (i.e., User ID and password for e-voting).
 - c) After logging in, click on "Video Conference" option
 - d) Then click on camera icon appearing against AGM event of Triveni Engineering & Industries Limited, to attend the Meeting.

Please note that the members who do not have the User ID and Password for e-voting or have forgotten their User ID and Password may retrieve the same by following the remote e-voting instructions mentioned in the notice.

- ii. Facility for joining AGM through VC/ OAVM shall open at least 30 minutes before the scheduled time for commencement of the Meeting. The facility of participation at the AGM through VC / OAVM will be made available for 2,000 members on 'first come first serve' basis. This will not include large shareholders (shareholders holding 2% or more equity shares), Institutional Investors and other specified category of persons who are allowed to attend the AGM without the aforesaid restriction. Institutional members are encouraged to participate at the AGM through VC / OAVM and vote thereat.
- iii. Members are encouraged to join the Meeting through Laptops/ Desktops with Google Chrome (preferred browser), Safari, Internet Explorer, Microsoft Edge, Mozilla Firefox 22. Members will be required to grant access to the webcam to enable VC / OAVM. Further, members connecting from Mobile Devices or Tablets or through Laptop connecting via Mobile Hotspot may experience Audio/Video loss due to fluctuation in their respective network. It is therefore recommended to use Stable Wi-Fi or LAN Connection to mitigate any kind of aforesaid glitches.
- iv. Those members who are present at the meeting through VC /OAVM and have not cast their vote through remote e-voting shall be eligible to cast their vote through e-voting system available during the AGM. E-voting (insta-poll) during the AGM is integrated with the VC / OAVM platform. The members may click on the voting icon displayed on the screen to cast their votes through insta-poll, which will be activated upon announcement by the Chairman at the AGM.
- v. A member can opt for only single mode of voting i.e., through Remote e-voting or voting at the AGM. If a member casts votes by both modes, then voting done through Remote e-voting shall prevail and vote at the AGM shall be treated as invalid.

(IV) Other Instructions

- i. **Speaker Registration:** The members who would like to express their views or ask questions on any items of the businesses to be transacted during the AGM may register themselves as speakers by logging on to <https://emeetings.kfintech.com> and clicking on the 'Speaker Registration' option available on the screen after login, which will be opened from **Tuesday, September 14, 2021 (10.00 a.m. IST) to Wednesday, September 15, 2021 (5.00 p.m. IST)**. Members shall be provided a 'queue number' before the meeting. The Company reserves the right to restrict the speakers at the AGM to only those Members who have registered themselves, depending on the availability of time for the AGM.
- ii. **Post your Question:** The Members who wish to post their questions prior to the meeting can do the same by visiting <https://emeetings.kfintech.com>. Please login through the user id and password provided in the mail received from KFintech. On successful login, select 'Post Your Question' option available upto Friday, September 10, 2021.

- iii. In case a person has become a Member of the Company after dispatch of AGM Notice but on or before the cut-off date for E-voting, he/she may obtain the User ID and Password in the manner as mentioned below:
- a. If the mobile number of the member is registered against Folio No./ DP ID Client ID, the member may send SMS: MYEPWD <space> E-Voting Event Number+Folio No. or DP ID Client ID to 9212993399
 1. Example for NSDL:
 2. MYEPWD <SPACE> IN12345612345678
 3. Example for CDSL:
 4. MYEPWD <SPACE> 1402345612345678
 5. Example for Physical:
 6. MYEPWD <SPACE> XXXX1234567890
 - b. If e-mail address or mobile number of the member is registered against Folio No. / DP ID Client ID, then on the home page of <https://evoting.kfintech.com/>, the member may click "Forgot Password" and enter Folio No. or DP ID Client ID and PAN to generate a password.
- iv. Members who may require any technical assistance or support before or during the AGM are requested to contact KFintech at toll free number 1800-309-4001 or write to them at evoting@kfintech.com.
22. The voting results along with the Scrutinizer's Report shall be placed on the website of the Company (www.trivenigroup.com) and on the website of KFintech (<https://evoting.kfintech.com>). The Company shall, simultaneously, forward the results to BSE and NSE, where the equity shares of the Company are listed within the stipulated time.

EXPLANATORY STATEMENT PURSUANT TO SECTION 102 OF THE COMPANIES ACT, 2013

Item No.4

The Board of Directors of the Company ('the Board') has at their meeting held on 29th June 2021, on the recommendation of Nomination and Remuneration Committee, appointed Mr Ajay Kumar Relan initially as an Additional Director on the Board of the Company pursuant to the provisions of Section 161 of the Companies Act, 2013 ('the Act') and also appointed him as a Non-Executive Independent Director subject to approval of the members, for a period of five years with effect from 29th June, 2021 to 28th June, 2026.

Mr. Ajay Kumar Relan, aged about 67 years, holds degree in B.A. (Hons.) in Economics from St. Stephen's College, Delhi University with 1st ranked in the University and MBA from Indian Institute of Management, Ahmedabad with specialization in Finance and Marketing.

Mr Relan is an experienced Private Equity professional with over three decades of full life cycle investment experience, across several sectors, including exit experience of returning more than a billion dollars & serving on several private & listed Boards. He started his career in the year 1976 as an Investment banker with Citibank serving across India, the Middle East, and Europe and returned to India in 1993 to head Citi's publicly listed company Citicorp Securities and Services Limited. He also served as a Director on the Board of several companies during the period between 1995 and 2008. In the year 2008, he ventured on his own to form CX Capital Partners, an independent India focused private equity fund and served as Partner/Chairman. At present, he is serving as founder, partner of Xponentia Capital Partners and as Director of companies like HT Media Ltd., Hindustan Media Ventures Ltd., Digicontent Ltd. Next Mediaworks Ltd., Next Radio Ltd., Capri Global Capital Ltd. and SIS Ltd. He has played an instrumental role in bringing successful IPOs for companies like Thyrocare, Ujjivan and SIS. Recently, he has raised 250 Mn USD funds for domestic (India) capital first.

Other than being a private equity professional, he is passionate in philanthropic activities and business mentoring in his leisure time. He has built the Vidya Comfort Academy, a school for underprivileged children located in Gurugram, serves as a trustee of the American Indian Foundation and is also a member of the Investment Committee of SHE Capital.

In terms of Section 160 of the Act, the Company has received notice from a member of the Company, signifying his intention to propose the candidature of Mr Relan for the office of an Independent Director of the Company.

The Company has received a declaration from Mr Relan confirming that he meets the criteria of independence under the Act and SEBI (Listing Obligations and Disclosure Requirements) Regulations, 2015 ('Listing Regulations'). Further, the Company has also received Mr Relan's consent to act as a Director and a declaration that he is not disqualified from being appointed as a Director in terms of Sections 152 and 164 of the Act respectively. Mr Relan has also confirmed that he has registered his name in the data bank of Independent Directors as being maintained by Indian Institute of Corporate Affairs in terms of Rule 6 of the Companies (Appointment and Qualification of Directors) Rules, 2014, as amended.

In the opinion of the Board, Mr Ajay Relan is a person of integrity and possesses appropriate skills, expertise and experience and fulfils the conditions specified in the Act and the Rules made thereunder and Listing Regulations for his appointment as an Independent Director of the Company and is independent of the management of the Company. Considering Mr Relan's skills, experience and knowledge, the Board is of the view that his presence on the Board would be of immense value to the Company.

The relevant information in respect of Mr Relan pursuant to Regulation 36(3) of the Listing Regulations and the Secretarial Standards on General Meetings is provided at Annexure A to this Notice. Draft terms and conditions for appointment of Mr Relan as an Independent Director shall be made available for inspection by the members through electronic mode.

The Board commends the passing of Resolution set out at Item No.4 of the Notice.

None of the Directors or any KMPs of the Company or their respective relatives except Mr Ajay Kumar Relan and his relatives to the extent of their shareholding interest, if any, in the Company are either directly or indirectly concerned or interested, financially or otherwise, in this Resolution.

Item No.5

The members of the Company had, at the 80th Annual General Meeting of the Company held on 14th September, 2016, approved by way of a special resolution under section 197 of the Companies Act, 2013, the payment of remuneration by way of commission to Non-Executive Directors (NEDs) of the Company within the ceiling of 1% per annum of the net profits as computed under the applicable provisions of the Companies Act, 2013 ('the Act') for a period of five years from the financial year commencing 1st April, 2016. The said approval was valid upto the financial year ended on 31st March, 2021.

The NEDs bring with them professional expertise, rich and wide experience and they contribute significantly to the growth of the Company. In order to remunerate the NEDs of the Company, it is proposed to seek approval of the shareholders in accordance with the provisions of Section 197 of the Act by way of a special resolution. Accordingly, consent of the members is sought for payment of remuneration by way of commission to NEDs (other than managing directors and the whole-time directors) for a period of five years from the financial year commencing April 1, 2021 subject to ceiling of one percent of the net profits of the Company for each year, computed in the manner specified in Section 198 of the Act. The quantum of such commission and its distribution thereof to all or any of the NEDs shall be determined by the Board each year based on the specified criteria. The payment of commission would be in addition to the sitting fees payable for attending meetings of the Board and Committees thereof.

The Board commends the passing of Special Resolution set out at Item No.5 of the Notice.

All the NEDs of the Company may be deemed to be concerned or interested in the Resolution set out at Item No.5 of the Notice to the extent of commission that may be received by each of them.

Mr Dhruv M. Sawhney, Chairman & Managing Director and Mr Tarun Sawhney, Vice Chairman and Managing Director of the Company may also be deemed to be interested, being related to Mr Nikhil Sawhney, one of the NEDs.

None of the other KMPs of the Company/their relatives are *either directly or indirectly* concerned or interested, financially or otherwise, in this Resolution.

Item No.6

The Registered Office of the Company is presently situated at Deoband, District Saharanpur, Uttar Pradesh-2477554. Considering the fact that the operational and business activities of the Company are undertaken from the Corporate Office at Noida (Uttar Pradesh), the Board of Directors of your Company at their meeting held on 14th August, 2021 has decided to shift the Registered Office of the Company from present location to 'A-44, Hosiery Complex, Phase-II Extension, Noida-201 305, Uttar Pradesh. This would enable to manage the affairs of the Company more effectively and efficiently and with better operational convenience and shall also facilitate better coordination and interaction with shareholders/investors.

As per provisions of Section 12 of the Companies Act, 2013 and the Rules made thereunder, shifting of Registered Office of the Company outside the local limits of any city, town or village but within the same State requires approval of the members by way of a Special Resolution and filing of the same in the prescribed form(s) with the Registrar of Companies, Uttar Pradesh (ROC) for registration.

The Board commends the passing of Special Resolution set out at Item No.6 of the Notice.

None of the Directors or any KMPs of the Company or their respective relatives are either directly or indirectly concerned or interested, financially or otherwise, in this Resolution.

Item No.7

The Board of Directors of the Company has, on the recommendation of the Audit Committee, approved the appointment and remuneration of the following Cost Accountants as Cost Auditors to conduct the audit of the cost records of the Company's businesses mentioned against each of them for the financial year ending March 31, 2022:-

Sr. No.	Name of the Cost Auditor	Business	Audit Fees* (Rs.)
1.	Mr Rishi Mohan Bansal	Sugar Business (including Cogeneration & Distillery)	4,71,900/-
2.	M/s GSR & Associates	Power Transmission Business	52,000/-

*plus applicable taxes and out of pocket expenses

In accordance with the provisions of Section 148 of the Companies Act, 2013 read with the Companies (Audit and Auditors) Rules, 2014, the remuneration payable to the Cost Auditors has to be ratified by the members of the Company. Accordingly, consent of the members is sought for ratification of the remuneration payable to the Cost Auditors for the financial year ending March 31, 2022, as mentioned above.

The Board commends the passing of Resolution set out at Item No.7 of the Notice.

None of the Directors or any KMPs of the Company or their respective relatives are either directly or indirectly concerned or interested, financially or otherwise, in this Resolution.

By Order of the Board

Geeta Bhalla
Group Vice President &
Company Secretary
M.No.9475

Date : August 14, 2021
Place: Noida

Details of Directors seeking appointment/re-appointment at the 85th AGM pursuant to Regulation 36(3) of the Listing Regulations and the Secretarial Standards on General Meetings

Name of the Director	Mr Tarun Sawhney	Mr Ajay Kumar Relan
DIN	00382878	00002632
Date of Birth	September 25, 1973	December 9, 1953
Nationality	Indian	Indian
Date of appointment on the Board	November 19, 2008	June 29, 2021
Qualifications	B.A. (Hons.) in Economics and Masters' degree in Arts from Emmanuel College, University of Cambridge, U.K. and Masters' degree in Business Administration from The Wharton School, University of Pennsylvania, U.S.A	B.A. (Hons.) in Economics from St. Stephen's College, Delhi University and MBA from Indian Institute of Management, Ahmedabad with specialization in Finance and Marketing.
Experience and Expertise	He is one of the promoters and also Vice Chairman & Managing Director of the Company. He has rich experience in the sugar and engineering Industry having adequate functional and management experience. He has also international exposure through working in foreign companies. He is the past president of Indian Sugar Mills Association (ISMA). His areas of expertise include general management and leadership, corporate governance and finance.	He is an experienced Private Equity professional with over three decades of full life cycle investment experience, across several sectors, including exit experience of returning more than a billion dollars & serving on several private & listed Boards. His areas of expertise include Investment Management & Value Maximization.
Directorship held in other public companies	Triveni Turbine Ltd. GE Triveni Ltd. Indian Sugar Exim Corporation Ltd.	HT Media Ltd. Hindustan Media Ventures Ltd. Digicontent Ltd. Next Mediaworks Ltd. Next Radio Ltd. HT Digital Streams Ltd. Capri Global Capital Ltd. SIS Ltd.
Memberships/ Chairmanships of Committees in other public companies*	Stakeholders' Relationship Committee Triveni Turbine Ltd. – Member	Audit Committee Next Mediaworks Ltd. - Chairman Next Radio Ltd.- Chairman HT Media Ltd. – Member Hindustan Media Ventures Ltd. - Member Digicontent Ltd. – Member Stakeholders' Relationship Committee HT Media Ltd. – Chairman Hindustan Media Ventures Ltd. - Chairman Digicontent Ltd - Chairman.
Number of Board Meetings attended during FY21	7/7	Not Applicable
Terms of appointment/re-appointment along with details of Remuneration	He is entitled to fixed monthly pay by way of salary, perquisites and allowances and variable performance bonus on yearly basis in accordance with the applicable provisions of the Companies Act, 2013. For terms of appointment and the remuneration last drawn by him, please refer to Corporate Governance Report forming part of Annual Report for FY21.	He is entitled to sitting fees for attending meetings of the Board and its Committees and profit related commission, if any, in accordance with the applicable provisions of the Companies Act, 2013. For terms of appointment, please refer to Resolution and Explanatory statement at Item No.4 of the Notice.
Shareholding	13820236 Equity Shares of Re.1/- each	Nil
Relationship between directors inter-se	Mr Tarun Sawhney is related as son with Mr Dhruv M. Sawhney, Chairman & Managing Director and as brother with Mr Nikhil Sawhney, Director of the Company.	None

*The Committees considered above are those prescribed under Regulation 26 of the Listing Regulations.

Registered office : Deoband, District Saharanpur, Uttar Pradesh-247 554
Corporate office : 8th Floor, Express Trade Towers, Plot No.15-16, Sector 16A, Noida- 201 301, Uttar Pradesh
Website: www.trivenigroup.com, **E-mail :** shares@trivenigroup.com, **Phone :** 91 120 4308000, **Fax :** 91 120 4311010-11,
CIN: L15421UP1932PLC022174



ANNUAL
REPORT
2020-21



**EXTRAORDINARY
TIMES. Exceptional
Response.**



Visit: www.trivenigroup.com
for more details about us

FORWARD-LOOKING STATEMENT

This report contains forward-looking statements, which may be identified by their use of words like 'plans', 'expects', 'will', 'anticipates', 'believes', 'intends', 'projects', 'estimates' or other words of similar meaning. All statements that address expectations or projections about the future, including but not limited to statements about the Company's strategy for growth, product development, market position, expenditures and financial results, are forward-looking statements. Forward-looking statements are based on certain assumptions and expectations of future events. The Company cannot guarantee that these assumptions and expectations are accurate or will be realised. The Company's actual results, performance or achievements could thus differ materially from those projected in any such forward-looking statements. The Company assumes no responsibility to publicly amend, modify or revise any forward-looking statements, on the basis of any subsequent developments, information or events. The Company has sourced the industry information from the publicly available resources and has not verified those information independently.

CONTENTS

CORPORATE OVERVIEW 01-43

- 02** How we Responded Proactively in FY 21
- 04** Business at a Glance
- 08** Performance Highlights for FY 21
- 10** Defining Moments... Redefining Strategies
- 14** 5-year Journey of Responsible Growth
- 16** Unlocking Exceptional Potential
- 22** Looking Ahead amid Extraordinary Challenges
- 26** Business Profile - Sugar
- 30** Business Profile - Power Transmission
- 40** Business Profile - Water

MANAGEMENT STATEMENTS 44-50

- 44** Message from the Chairman
- 46** Q&A with the Vice Chairman & Managing Director

STATUTORY REPORTS 51-131

- 51** Management Discussion and Analysis
- 75** Financial Review
- 81** Risk Management and Mitigation
- 84** Directors' Report
- 94** Corporate Governance Report
- 122** Business Responsibility Report

FINANCIAL STATEMENTS 132-334

- 132** Standalone Financials
- 232** Consolidated Financials

These were **EXTRAORDINARY TIMES.** Demanding an **EXCEPTIONAL RESPONSE.**

The COVID-19 pandemic tested businesses like never before.

It necessitated a new strategic approach to manage the complexities of the evolving situation.

At Triveni, we pushed the barriers of our strengths to meet the challenge head-on with dynamism.

We focussed on leveraging our experience and expertise, to respond effectively to the transforming needs of our customers in the new normal.

We did not just react to the changing environment, but went beyond, to pre-empt and prepare for the demands of the future.

We stayed firmly on course to further strengthen our operational and cost efficiencies, to deliver an excellent performance in the midst of these unprecedented circumstances.

**READ ON TO FIND OUT
HOW WE SUCCEEDED IN
ACCOMPLISHING THIS FEAT!**



HOW WE RESPONDED PROACTIVELY... TO DELIVER PERFORMANCE EXCELLENCE

Responding with unparalleled agility, we successfully steered our business through unprecedented challenges to deliver outstanding performance for FY 21. Our response to COVID-19 was both cautious and aggressive, and we took several targeted initiatives to protect the health and safety of our employees, supply chain partners, communities and other stakeholders, while ensuring business continuity in a complex environment.

Driving growth in Sugar & Alcohol businesses

In the Sugar and Alcohol business, where operations continued uninterrupted even amid the lockdown, we delivered strong performance in a difficult eco-system

- With the active support of the Central and State Governments, we effectively managed the supply chain and logistics issues in the restrictive environment that prevailed during the shutdown and even after
- We chose not just to maintain business continuity in these difficult times but went on to expand our Alcohol segment with increased capacities and foray into the Indian Made Indian Liquor (IMIL) business
- We also moved forward with plans to add two more distilleries to the business portfolio, to aggressively harness the National Policy on Biofuels opportunity unleashed by the Central Government
- With our entry into the hand sanitizer manufacturing business under the GERM CARE brand, we have expanded our distillery portfolio

Responding to the urgent needs of the communities in the crisis situation, we distributed hand sanitizers under the GERM CARE brand, to local administration and authorities to help fight the contagion. Sanitization of the local areas, distribution of masks and Oxymeters, and safety measures for farmers at the sugarcane centres and the mill gates were some of the other initiatives undertaken to keep the external communities protected at all times.

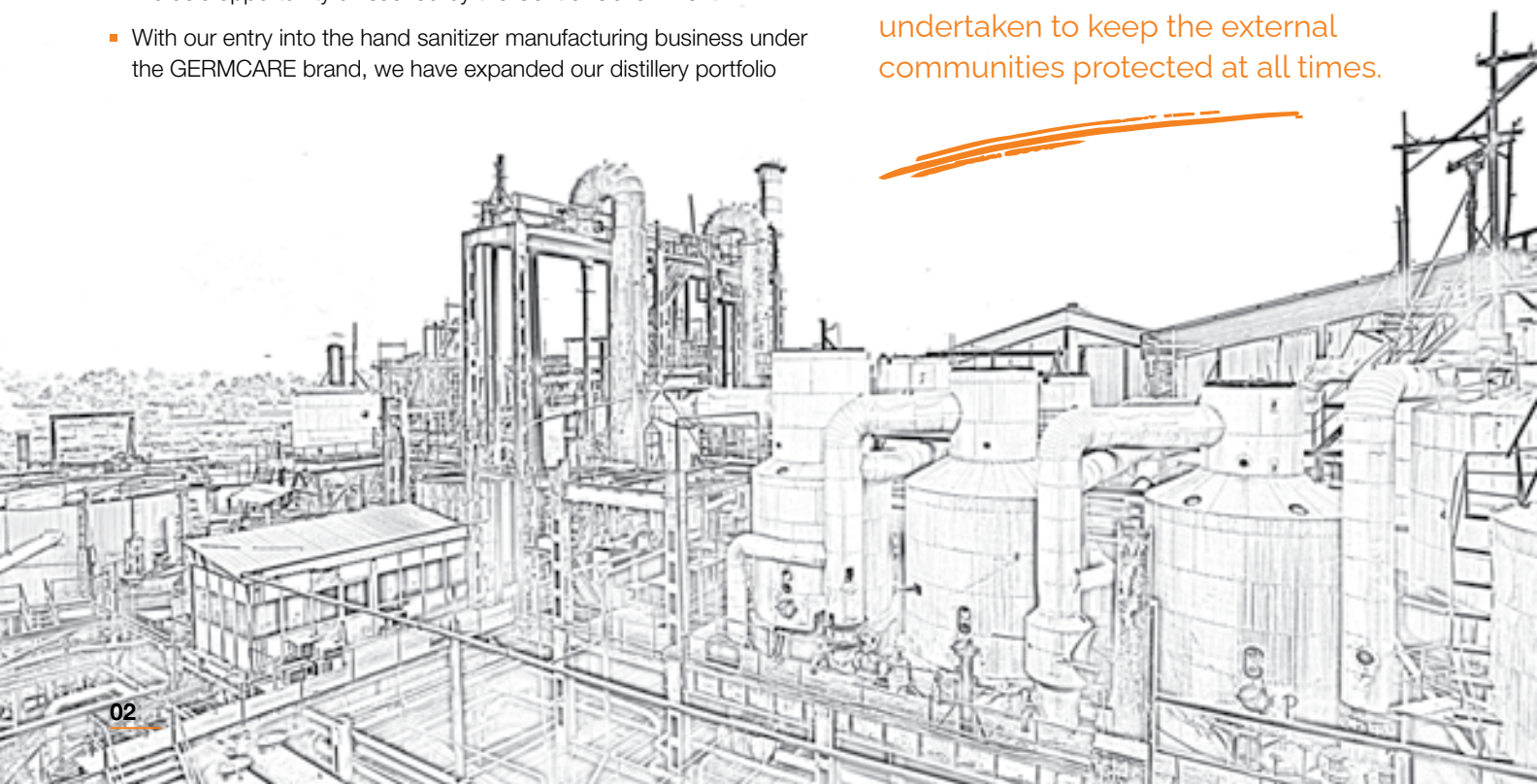

Managing challenges in Engineering businesses

Leveraging our intrinsic strengths, expertise, technological and digital edge, we moved swiftly to address the challenges triggered by the pandemic in the Engineering businesses.

During the lockdown period, our teams worked actively in changing the conventional route of communications with customers, prospective business leads, as well as within the Company. Digital channels were adopted at a fast pace across the businesses. Sales team worked closely with the customers through digital platforms to fulfil their requirements. Realignment of product deliveries was undertaken in Power Transmission business in line with the revised project execution plans of the customers. Our efforts to promote operational and cost efficiencies also yielded results, enabling us to manage costs better in a highly distressed situation.

Water business focussed on enhancing the business footprint from the domestic market to the international, and succeeded in winning its first International order of Maldives Water & Sewerage project. We facilitated customers with virtual inspections of the project to avoid travel amid rising COVID cases and travel restrictions. This was implemented across our major projects like Mathura, Kondli & Balotra. Operations and Maintenance (O&M) services were continued even during lockdown/curfew, and the business teams made necessary arrangements for safe travel of its people and adherence to Government protocols. This was highly important in case of Agra, where our Water treatment plant supplies drinking water to the people in the city.

Ensuring safer communities at the workplace

Our proactive actions of introducing safety policies and protocols helped us keep not just our employees but also our supply chain partners, including our farmer associates, safe and secure amid the COVID pandemic. Contactless engagement and supply points were created at the sugar and distillery plants, with stringent safety norms in place at all our offices and factories across India. All precautions were strictly followed to ensure total protection of our own people as well as those visiting the premises. Standard Operating Procedures (SOPs), such as compulsory wearing of masks, temperature scanning and disinfection of employees at entry points, and sanitization of workplace at regular intervals not only helped in maintaining employee safety but enabled seamless business continuity in the adverse environment.

DIGITALISING

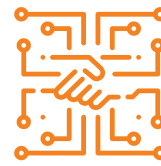

to sustain business

We transitioned swiftly to the digital mode at the onset of the pandemic to create online customer touchpoints within 72 hours. We took several initiatives to stay in close contact with our customers and efficiently manage business, in order to stay ahead of our peers in these challenging times.

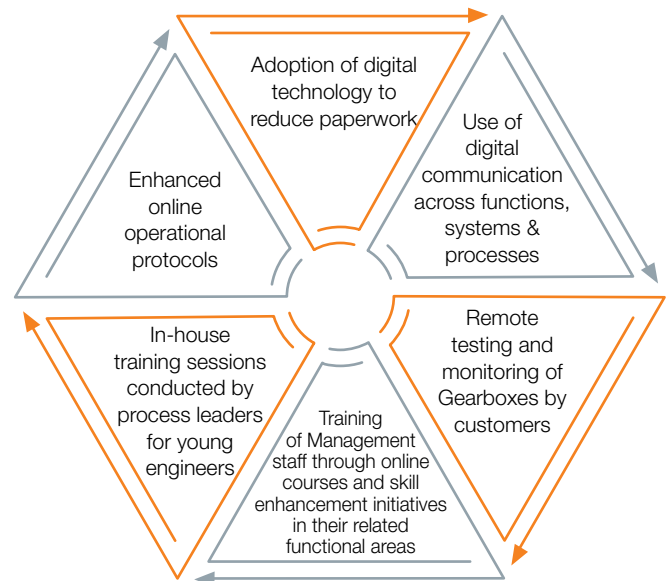

Extending a helping hand to the society

As a responsible citizen, we focussed on the welfare and well-being of the communities around which we operate. We initiated several measures to ensure the socio-economic empowerment of these communities, particularly our farmer partners, who are integral to our growth. During 2020, we set up the Triveni Foundation to give a more focussed direction to our CSR programme, with thrust on COVID management, in addition to the ongoing Water management initiatives and inculcation of Sports spirit among children and youth in the rural areas.

BUSINESS AT A GLANCE

Triveni Engineering & Industries Limited is a diversified, integrated and sustainable organisation, rooted in innovation, quality and customer-centricity. We are one of the largest integrated Sugar manufacturers in India and a market leader in our Engineering businesses.

Who we are

We are an industry-leading organisation, with extensive expertise in delivering quality products and solutions to a growing clientele across geographies. The foundation of our profitable growth and sustained value delivery is built on our network of strong relationships, research & development capabilities, excellence in manufacturing, engineering efficiency and stringent quality controls. We run our operations with strict adherence to all Environment, Health & Safety (EHS) norms to provide clean, safe and healthy working conditions to our employees, and total protection to the communities around which we operate.

With our continuous investments in world-class technology and Industry 4.0 best practices, we ensure premium quality products with fast deliveries and cost efficiencies.



17

World-class facilities

What we do

Our leadership spans the key segments of Sugar and Engineering, with an expanding presence across some of the fastest-growing markets within and outside India.

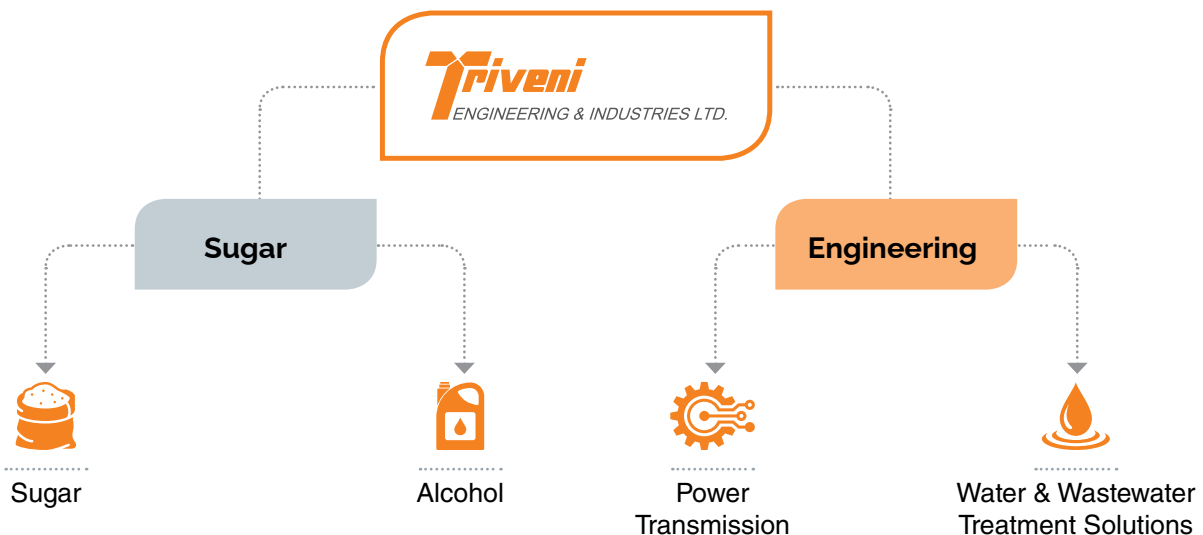

Sugar Businesses – A Snapshot



Sugar

- Among the largest integrated sugar manufacturers in India
- Association with Indian farmers is as old as the industry itself
- Produce power from co-product Bagasse - a residue of sugarcane crushing
- Power used to meet captive needs, and surplus sold to Uttar Pradesh Power Corporation Limited
- Integrated operations to produce multi-grade sugar, potable alcohol, ethanol & power co-generation
- Products include Multi-grade - Large, Medium and Small Crystal - Sugar, Refined Sugar, Raw Sugar, Pharmaceutical-grade Sugar
- 7 FSSCI 22000 certified sugar units in the sugar-rich UP belt
- Extensive sugarcane development programme with 3+ lakh farmers
- 6 co-generation plants with three plants utilising highly efficient 87 ata/515 degree C steam cycle
- 104.5 MW grid connected co-generation capacity



Alcohol

- Producers of ENA (which is used to produce Potable Alcohol) & Fuel-Grade Ethanol
- 2 state-of-the-art distilleries at Muzaffarnagar (MZN) & Sabitgarh (SBT)
- 320 KLPD current capacity - operating 350 days a year
- MZN has flexible product manufacturing capability - Ethanol, Extra Neutral Alcohol (ENA), Rectified Spirit (RS) and Denatured Spirit (SDS)
- High-quality Ethanol manufactured at SBT distillery
- Hand Sanitizer (GERMCARE) manufactured at Muzaffarnagar distillery
- Indian Made Indian Liquor (IMIL) production started at MZN
- Zero Liquid Discharge & stringent Environmental norms at distilleries
- Plan to enhance the total distillation capacity to 660 KLPD before the commencement of the Sugar Season (SS) 2022-23 with expansion of existing distilleries and two new plants in the pipeline
- The first is a new distillery being set up at our Milak Narayanpur sugar mill, which will be operated on molasses/sugarcane juice & syrup/grain. The second is a new grain-based distillery being set up at Muzaffarnagar

Engineering Businesses – A Snapshot



Power Transmission

- Largest manufacturer of customised and reliable Turbo gears in India
- India's largest manufacturer of industrial high-speed gears and gearboxes
- Triveni Defence Business, a strategic business unit, is an OEM for many important defence products and solutions to Indian Navy & Indian Coast Guard
- Present in 3 different business segments – Gears, Defence, Built-to-Print
- State-of-the-art Integrated manufacturing facility
- Unmatched world-class delivery time
- Reputation for reliability and technical excellence of products
- Trusted & reliable supplier for Indian Navy
- Approved supplier of Propulsion Gearboxes, Gas Turbine Generators, Steam Turbines, Turbo auxiliaries and special application turbo & motor-driven pumps for the Indian Navy and Coast Guard
- High-quality products being manufactured at Mysuru facility
- Research & Development expertise on critical turbo products
- Also registered with the Director General of Quality Assurance



Water & Wastewater Treatment Solutions

- Leading solutions provider for efficient water management for industrial/municipal/urban applications
- Full range of innovative water/wastewater treatment solutions across all the major water usage segments
- Leveraging technology to provide customised, sustainable EPC solutions/services
- Efficient total water management across the water cycle
- ~10,000 Million Litres Per Day (MLD) water treated
- >2,000 process equipment supplied and commissioned
- Executed some of the largest projects in India

What drives us

Our ability to deliver exceptional response to our stakeholder needs and aspirations, in even the most difficult circumstances, is driven by our vision and philosophy. It is steered by our customer-centric ethos, with responsible growth at the centre of our strategic approach and actions.

Founding Group Principles



Ethics

- Professional and transparent business practices
- Strong focus on Corporate Governance and EHS



Product Quality

- Best-in-class manufacturing
- Internationally benchmarked on quality standards



Technology

- Consistent R&D of technology to surpass customer needs
- Experienced team with an Innovation forward mindset



Strong Relationships

- Sustainable solutions that create a high degree of value for our customers
- Strong networks in place to enable smooth business operations



Sustainability

- Leadership in all our business lines with sustainability at the core
- Enabling Environmentally responsive operations



Our Vision

We strive to maintain sustainable business growth through continuous innovation, market development and customer retention while creating long-term value for all our stakeholders.



Our Mission

We are committed to providing premium quality products, innovative and sustainable solutions that create value for our customers. We continue to look at ways we can make a positive environmental, societal and economic difference for the community at large. We build diverse teams and provide equal growth opportunities to all our employees.

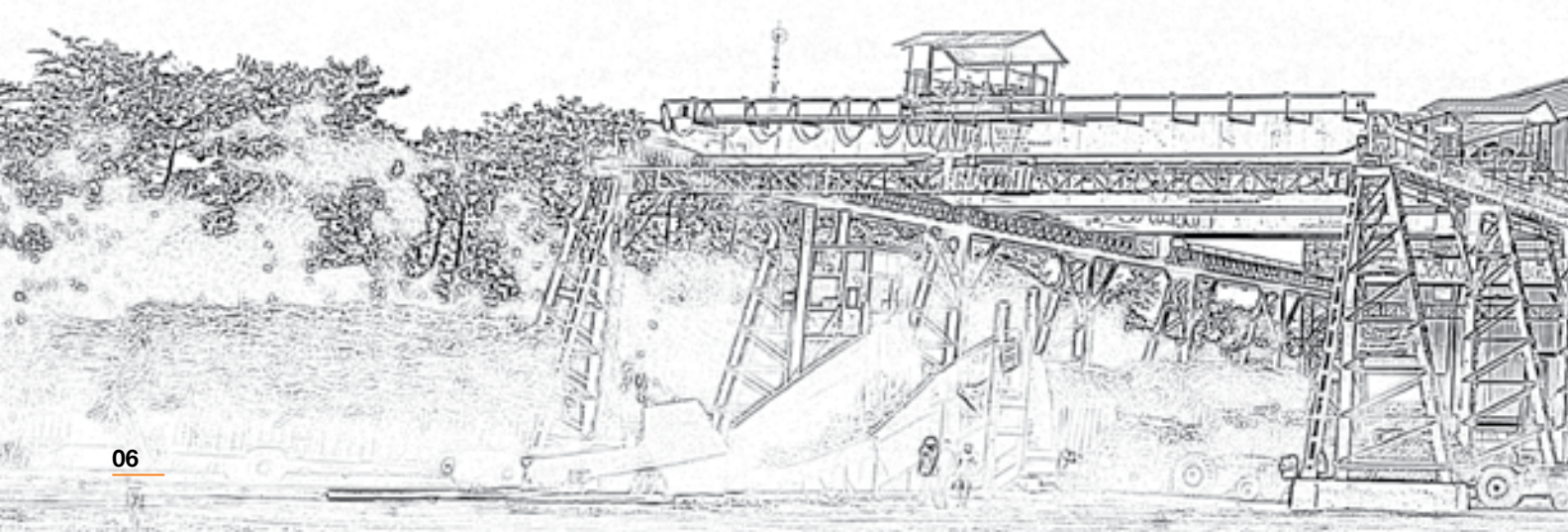



Our Values



Open

We believe in open communication. We listen to our stakeholders and respond to their suggestions.



Pro-active

We understand customers' needs, offer new solutions customised to their requirements and aim to exceed their expectations.



Commitment

We are committed to our customers and live up to promises.



Innovation

We are always willing to improve our products and service through continuous research and development.



Being Responsive through Responsible Growth

Sustainable and responsible growth is a key tenet of our business strategy. It is the source of our ability to cater to the evolving requirements of our customers and to the urgent needs of the communities around which we work. It is also the powerhouse of our responsiveness to the long-term aspirations of our employees and all other stakeholders.

This focus on sustainable growth is also ingrained in our Corporate Social Responsibility (CSR) philosophy and empowers us to provide meaningful social and economic interventions in the vital areas of education, healthcare, hygiene etc. to the communities around our operations. We sharpened this focus further amid the COVID pandemic, to reach out more effectively to the most vulnerable sections of the society.

POWERING GROWTH

through Innovation



Innovation is another major propeller of our business proposition and we remain steadfastly focussed on augmenting our research & development capabilities through skill and technology upgradation. Regular mapping and analysis of market trends helps us understand and cater to the customer's evolving needs better. We work closely with scientists & agri-research institutes on the latest agronomic developments in the Sugar business, while our association with leading technology providers in the Engineering business gives us a strong edge that helps us in achieving breakthrough solutions to cater to our customer requirements.

PERFORMANCE HIGHLIGHTS FOR FY 21

FY 21 witnessed the Company achieve remarkable performance across its business segments, with several significant achievements to mark a milestone year in its journey.



6%

Growth in Revenue
(Consolidated)



Zero

Liquid Discharge
at both Distilleries



AA- long-term with Positive
Outlook and A1+ short-term
rating accredited by ICRA



₹ 1,078.25 Crore

Outstanding Order Book
(Power Transmission and Water Business)





₹ **912.02** Crore

Water Business Order Book
as on March 31, 2021



0.94 Million Tonnes

Sugar Production in SS 2020-21



>50,000 MW

Gears Capacity
Installed Globally



~10,000 MLD

Water & Wastewater treated through
Triveni projects



.... DEFINING MOMENTS

A year that saw an unprecedented transformation in our businesses operating systems and methodologies.

Extraordinary challenges faced

With the COVID-19 pandemic triggering a new set of unique challenges, across the value chain of our business, we faced some extremely complex and difficult problems, which inspired us to deep-dive into our core strengths and formulate a comprehensive response strategy.

While our Sugar operations continued uninterrupted, some impact was felt in the form of logistics challenges. Our responsive approach enabled us to tackle these effectively with the active support of the State and Central Governments. Demand also remained under pressure for some time, particularly in the Food & Beverages as well as Confectionery segments, but off-take picked up, with the resumption of manufacturing activity in the country catalysing both institutional and consumer demand. Sugar exports were impacted for a brief period, with significant quantities stuck at the ports. However, by the end of the first quarter, the momentum picked up to boost exports, as we moved swiftly to harness the opportunity offered by the Government of India's quota allocation.

In our Engineering businesses, which faced total shutdown of operations during the lockdown period but returned to normal by mid-May 2020. We raised the bar of our efficiencies by focussing on digital transformation. We actively embraced the new digital regime of remote operations and online business processes to effectively manage the challenge of resource mobilisation amid travel restrictions. Supply chain challenges remained a matter of concern in the Power Transmission business for the first half of the year in particular, while the pandemic also slowed the process of tendering and finalisation of orders of the Water business. However, the demand gained momentum in the second half of the fiscal, enabling the Company to minimise the impact and report a decent overall performance, given the situation.

We actively embraced the new digital regime of remote operations and online business processes to effectively manage the challenge of resource mobilisation amid travel restrictions.

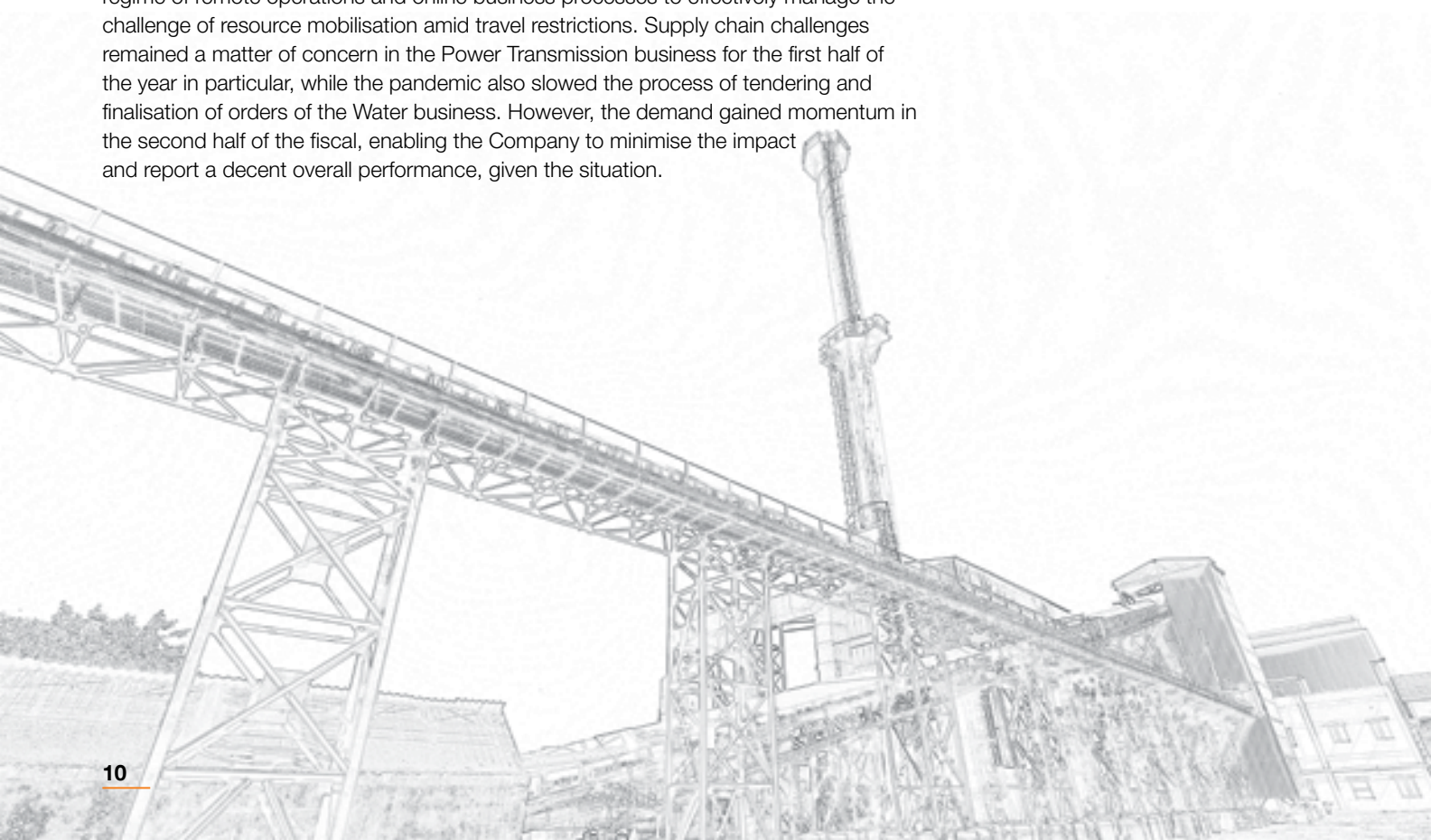

...REDEFINING STRATEGIES

A year that saw us rework our strategic approach to align it more effectively to the transforming ecosystem.

Exceptional response delivered

With our intrinsic strengths and deep-rooted understanding of the needs and aspirations of all our stakeholder groups, we were quick to reorient our systems and processes to function efficiently in the new normal.

Amid the extraordinarily difficult macro environment that prevailed through FY 21, Triveni ended the year with a healthy performance, driven mainly by its exceptionally responsive business strategy. The Gross Revenue from Operations stood at ₹ 4,703.35 crore – a growth of 6%, with Profit before Tax (before exceptional items) reporting a 3% growth, to end the year at ₹ 459.10 crore (on consolidated basis).

Aligning ourselves to the transformation in the external environment, we went in for some quick business realignments, with sharp shifts in the operational modus operandi. Our decision to foray into the manufacture of hand sanitizers at our Muzaffarnagar distillery was one such strategic shift, with our responsiveness manifest in the fact that production of the Triveni hand sanitizers under the brand GERM CARE had started as early as April 2020.

Automation and digitalisation became synonymous with the new way of functioning, with our IT teams working relentlessly to steer an organisation-wide business transformation amid the new normal. New technologies were adopted with extraordinary speed and we also moved fast to embrace Internet of Things (IoT) and Industry 4.0 practices, particularly in our Power Transmission and Water businesses, to enhance productivity while complying with the various restrictions that were imposed across the country amid the pandemic crisis. In the Sugar business too, our IT teams worked closely with the state and district administrations to ensure business continuity. We went almost contactless for about 1,75,000 contact points per day, across the Group, in a matter of just 96 days.

At the same time, as a responsible corporate, we strengthened our Safety Management Systems across our plants and workplaces, to ensure safe and secure operations for our people, as well as the communities around which we operate. Our Emergency Response Systems were augmented to address the critical COVID-19 pandemic challenge of working amid increased risks and restrictions.

These initiatives translated into quick recovery across business segments post the lockdown period.

Automation and digitalisation became synonymous with the new way of functioning, with our IT teams working relentlessly to steer an organisation-wide business transformation amid the new normal.

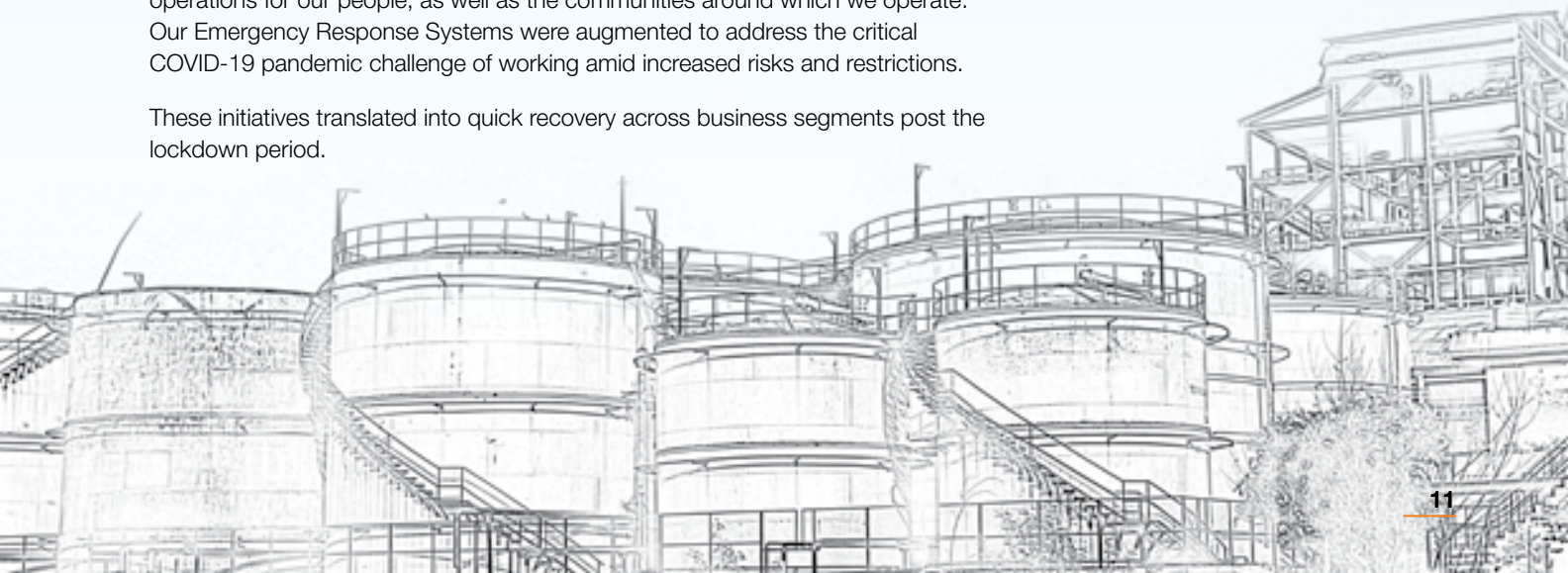

STRATEGIC FORAY INTO HAND SANITIZERS

A case study of our crisis response

Back in March 2020, faced with the sudden and unexpected outbreak of the COVID-19 pandemic, India was gripped by an acute shortage of hand sanitizers. As supplies struggled to cope with the spiralling demand, there was a nationwide search for urgent, effective and quick solutions.

At Triveni, we responded with exceptional speed and agility to start production of hand sanitizers, under the brand name 'GERMCARE', within just five days of the imposition of the lockdown.

The Challenge

India needed tens of thousands of bottles of good quality hand sanitizers almost overnight, to protect millions of its people. And it needed them fast. The biggest challenge was to develop the product and go to the market with it within an incredibly short period of time. What further exacerbated the challenge was that the project had to be undertaken with strict adherence to all the Government advisories during the lockdown period.

The Response

It took us just five days to start manufacturing hand sanitizers benchmarked to World Health Organisation (WHO) standards, in order to support the Government of India in meeting this unparalleled demand. We moved expeditiously to leverage our in-house capabilities and technology to develop the entire project ourselves.

We quickly reoriented our strategy in response to the COVID-19 pandemic – And GERM CARE was born!



HOW WE Did It...



We produce the main ingredient needed in the production of the World Health Organisation (WHO) recommended formulation, that is 80% Ethyl Alcohol, at our existing distillery at Muzaffarnagar. Some of the other ingredients, needed in small quantities, were sourced from the market, while the balancing component – demineralised water – was produced internally. Bottling and packaging was also done in-house.

WE WERE supported by...



The existing distillery staff rose to the occasion to provide supervisory services in the production of the sanitizers. Our sourcing partners also extended their dedicated support to us in this venture. We also got excellent support from the Government, which was extremely proactive in giving all necessary approvals on priority basis and in helping us ensure expeditious and seamless distribution of the product.

The Benefits

- With this foray, we successfully catered to some of the most urgent requirement of the Government of India, thus supporting its efforts to combat the pandemic. We supplied the sanitizer to district administrations free of cost, and to various central and state government offices/authorities/institutions at a subsidised rate of ₹ 100/litre
- We assisted MSMEs in our own and neighbouring districts by ensuring that our products reach them at competitive prices, so that even the MSME/unorganised industry could provide sanitizers to their workers and also sanitize the workplace
- We employed around 30-40 unskilled people from the distillery's neighbourhood to support the existing distillery workforce, thus providing employment to the rural unskilled workforce
- We are also selling the sanitizer in the open market at cost competitive rates, through various commercial distribution channels

Manufactured with a WHO recommended formulation that kills up to 99.9% germs and bacteria, without the use of water, GERM CARE provides quality and safe hand care and hygiene, for total and long-lasting protection from the virus.



5-YEAR JOURNEY OF RESPONSIBLE GROWTH

Responsible growth has always been central to the Triveni business strategy and FY 21 witnessed a sharper focus on the same, as we moved towards a more responsive approach for a sustained and long-term value creation and delivery for all our stakeholders.

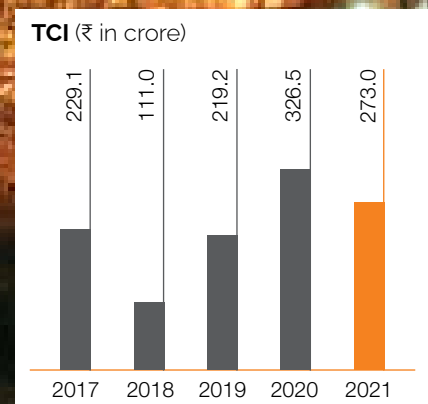
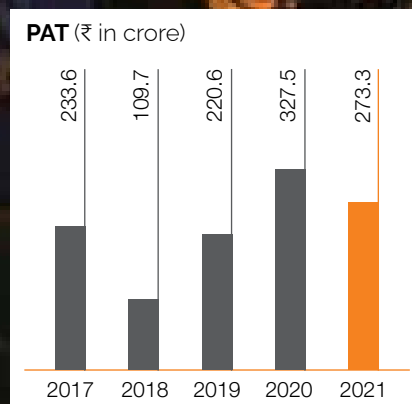
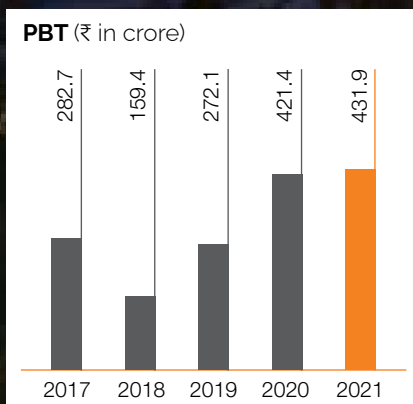
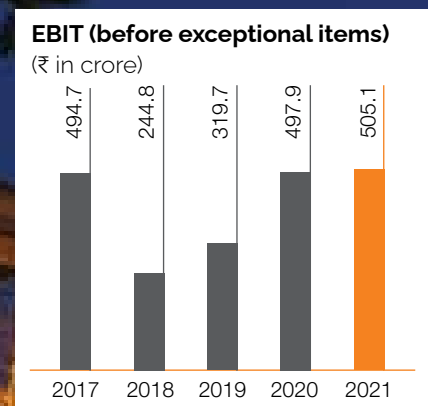
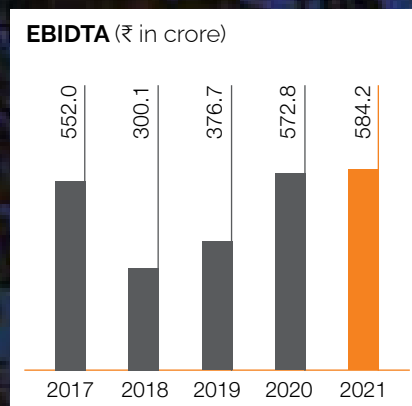
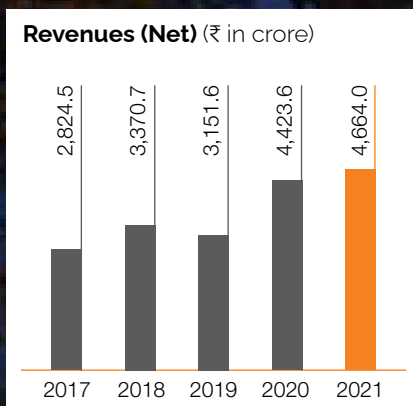

(Data pertains to Financial Years, unless otherwise mentioned)

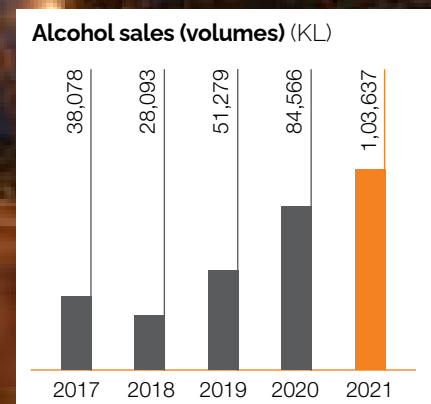
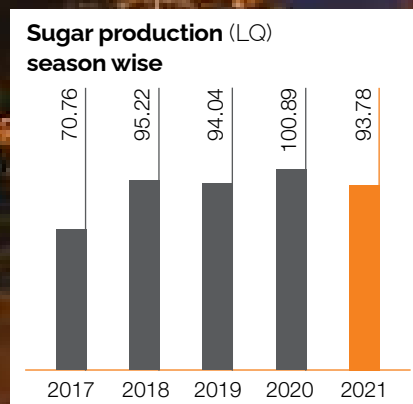
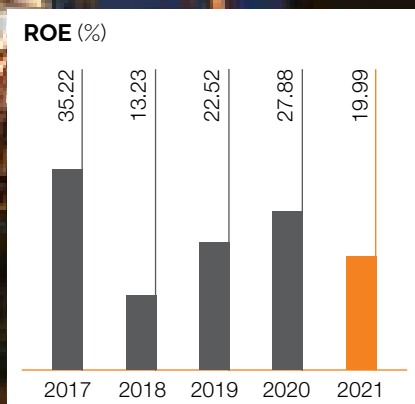
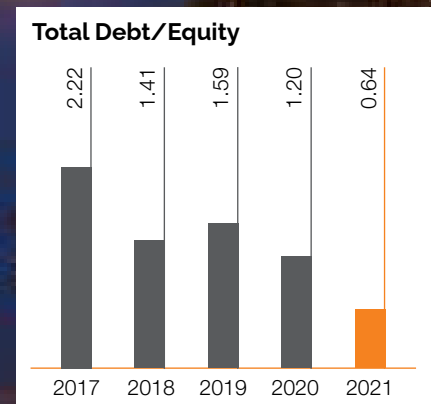
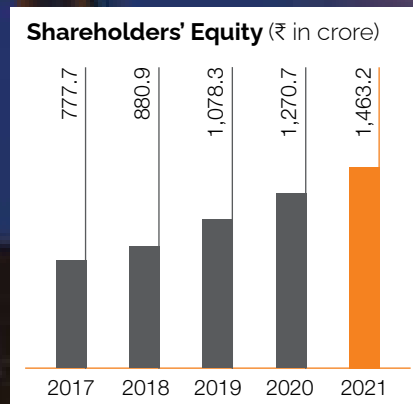
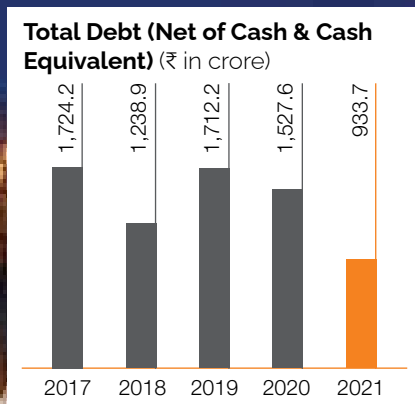

(Data pertains to Financial Years, unless otherwise mentioned)

Gearbox orders
delivered from
FY15 - FY21

1,869

Globally installed
gears capacity
over

50 GW

Countries
present in

70

Total gearboxes
under operation
as on April 1, 2021

10,591

SUGAR BUSINESS PERFORMANCE

UNLOCKING EXCEPTIONAL POTENTIAL

The complexities and volatility of Sugar manufacturing notwithstanding, we once again delivered outstanding performance in this segment during FY 21. What enabled us to drive sustained growth was our focussed strategic approach of proactively identifying and tapping into the business potential across the value chain. Our sustainable growth in our Sugar business segment has been maintained through: a) the stringent quality controls we exercise across the value chain, b) our seamless logistics and delivery systems, c) and our concerted focus on sustaining operational and cost efficiencies.

With effect from April 1, 2020, we have combined the Co-generation operations with the Sugar operations and the co-generation activities are no longer a separate operating segment for the Company.



Sugar potential unlocked in SS 2020-21

The performance of our Sugar segment remained in line with expectations during the year, despite the difficult macro environment. In terms of sugar production, the Company has been ranked second in the country, with the Khatauli Sugar Mill achieving the highest sugar production as a single unit and second highest sugarcane crush. The Sabitgarh and Rani Nangal units recorded their highest ever crush during the year.

Early start of the sugarcane crushing operations and efficient supply-chain management helped us to maintain our crushing volumes. Our deep-rooted relationships with farmers, which we continued to actively nurture through strategic interventions and investments even amid the COVID challenges, proved to be a major factor in boosting our crushing, and resultantly our production. Higher sugar and ethanol despatches during the year led to increased turnover of Sugar business, helping to compensate for the decline in the Engineering business resulting from the lockdown and COVID-related issues. Even though the yields have decreased throughout the state of U.P., and there has been an impact of red rot in eastern as well as central UP, we managed to maintain higher recovery as compared to the U.P. average.

MORE potential ahead...

As we move forward, we shall adopt a multi-pronged strategy to seize the unfolding opportunities in this business segment. Even as we continue to focus actively on capacity and efficiency enhancement, we aim to ramp-up the diversification of our sugar portfolio, with a varietal substitution programme to reduce our dependence on the miracle variety - Co-0238. Besides helping mitigate the risks of Co-0238.





Seeing opportunity in Alco Beverages

Better working capital management and lowering of our cost of funds remains integral to our growth-led business strategy. In line with this strategic approach, we continued, during the year, to look for potential sources of making the optimal use of our existing assets. One such asset is our 160 KLPD distillery at Muzaffarnagar (Uttar Pradesh), which has the capacity to manufacture quality ENA (potable alcohol).

With research by an external agency, specially hired by the Company, showing potential for growth in the IMIL market in U.P., we decided it was the right time for us to leverage our in-house ENA production facility. We thus strategically forayed into the Potable Liquor market - Indian Made Indian Liquor (IMIL) - towards the end of third quarter during the financial year under review. We are now manufacturing IMIL at the bottling facility of our Muzaffarnagar alco-chemical premises, through our Alcohol vertical, which forms part of our Distillery operating segment.

In addition to the benefit of value addition to our ENA production, this forward integration will help reduce our obligation to supply the Molasses (termed as Levy Molasses) to various other IMIL manufacturing units, at a price much lower than the market rate. The venture is also aligned to our vision of entering Indian Made Foreign Liquor (IMFL) bottling in the near future, as the experience we gain from potable liquor production would help in the IMFL bottling foray. The Company has received an approval to process ENA up to 52.8 lakh litres for manufacture of IMIL, and it has plans to increase the capacity up to 3 lakh cases per month in phases.

We are also planning to launch IMIL under multiple brands with attractive packaging, for enhanced and superior market penetration in this segment.

We strategically forayed into the Potable Liquor market - Indian Made Indian Liquor (IMIL) - towards the end of third quarter during the financial year under review.

Performance Highlights - Integrated Sugar Operations

8.54 Million Tonnes

Sugarcane Crushed
(SS 2020-21)

0.94 Million Tonnes

Sugar Production
(SS 2020-21)

11.86%

Gross Sugar Recovery
(SS 2020-21)

₹32,703 per MT

Domestic Realisation Price

2.24 Lakh Tonnes

Sugar Exported

56%

Ethanol Produced from
B-heavy Molasses

1,07,027 Kilolitres

Total Production from
existing Distilleries

~ 100%

Capacity Utilisation at
Distilleries

224 Million Units

Total Power Export

Area under sugarcane (Ha)

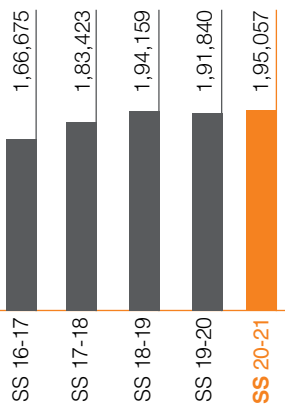

Sugarcane crushed (LQ)

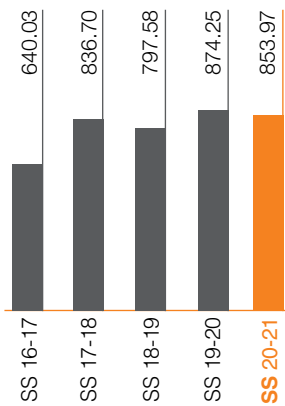

Sugar produced (LQ)

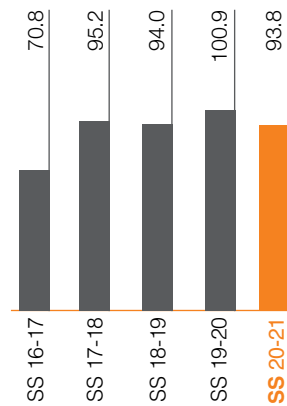

Recovery (%)

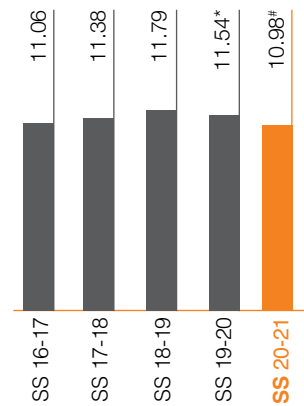

Gross Recoveries (after adjustment on account of B-heavy molasses): #11.86% for SS 20-21, *11.97% for SS 19-20

RESPONDING TO ETHANOL MARKET OPPORTUNITY

A case study of our market response

India has witnessed large-scale growth in Ethanol production in recent years, with the new ethanol blending and pricing policy proving to be a game-changer. For Sugar companies, this has opened up new vistas of opportunity, enabling them to divert additional sugarcane for ethanol production and helping them ease their liquidity crunch.

We, at Triveni, have been leveraging the capacities, capabilities and efficiencies of our distilleries effectively to make the most of the Ethanol opportunity unleashed by the Government of India's National Policy on Biofuels.

In response to the business landscape, we are strategically mapping our business to the Ethanol growth potential.

The Backdrop

The Central Government's growing focus on reducing its dependence on imported crude, while minimising the environmental impacts of pollution, has led to a surge in Ethanol production in recent years. The various incentives and initiatives taken by the Government to promote the production and blending of fuel ethanol with petrol has pushed demand for ethanol, as India moves towards the targeted 10% blending (EBP10) by 2022 and 20% (EBP20) blending by 2025. With growth in population and urbanisation pushing the requirement of mobility, the transport sector has witnessed rapid growth, leading to increased demand for non-conventional fuels.

The Response

In the SS 2019-20, three of our units undertook B-heavy diversion for ethanol production, while for SS 2020-21, the number went up to five sugar units, in tandem with the increasing demand and the resultant growth potential. Ethanol is one of the products manufactured at our state-of-the-art distillery at Muzaffarnagar, based on the market dynamics and requirements, while our Sabitgarh distillery is only producing ethanol. Over the last few years, the bulk of production from our existing distilleries has been ethanol, for supply to Oil Marketing Companies (OMCs) for blending in petrol.

For the Marketing Year 2020-21, Oil Marketing Companies (OMCs) have issued a tender for 457.6 crore litres, creating opportunities for sugar manufacturing companies to bolster their ethanol production. We secured contracts of 10.09 crore litres from OMCs during the ethanol supply year 2020-21.



The Benefits

- For the nation, the Government's blending programme is leading to increase in domestic energy production, translating into increased energy security
- It is also helping India reduce its import bill, thus helping in foreign exchange savings
- The Sugar industry is gaining through management of surplus sugar production due to diversion of sugar for ethanol production
- Since ethanol is a value-added product from molasses - a co-product in the manufacture of sugar from sugarcane, the benefit of ethanol production also percolates to the sugarcane farmers across the country. Blending of Ethanol with Petrol reduce the greenhouse gas emission which helps to save environment

WAY forward



Ethanol blending in India has already reached more than 7.2%, putting the country on course to meet the target of 10% blending by 2022. We are also continuously scaling up our capacities to garner a bigger share of the ethanol opportunity pie. We are geared up to operationalise our two newly approved distilleries at Muzaffarnagar and Milak Narayanpur, which will further sharpen our competitive edge in this business.

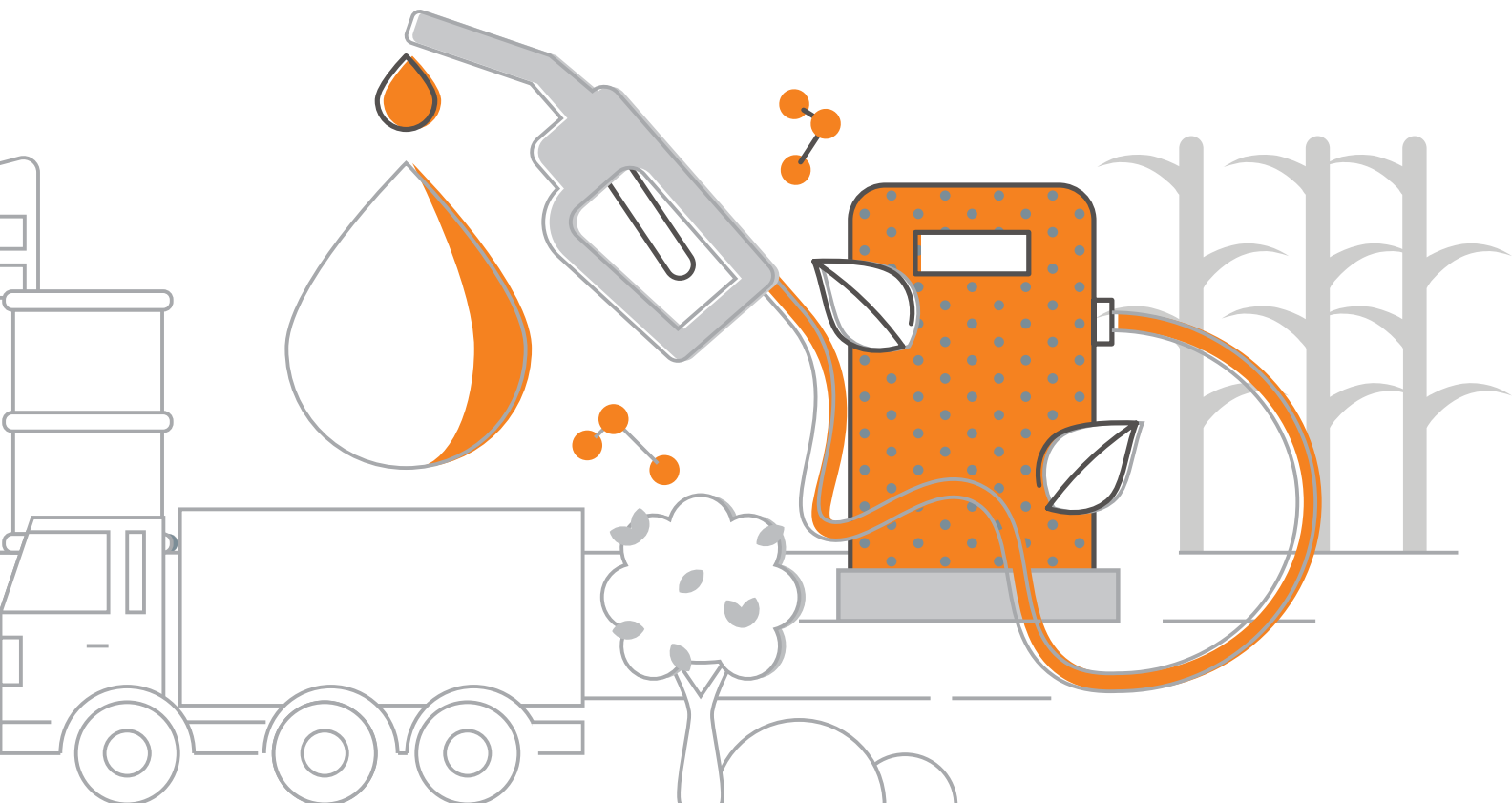

ENGINEERING BUSINESSES PERFORMANCE LOOKING AHEAD AMID EXTRAORDINARY CHALLENGES

Seeing beyond the problems of the pandemic, we further sharpened our ability, in FY 21, to find opportunity in adversity, even as we battled the hardships triggered by the lockdown. The shutdown had brought operations in our Engineering business to a standstill for about six weeks at the start of the year amid the COVID pandemic. As operations resumed, in a phased manner, things started looking up, with new opportunities opening up to put growth back on track in our Engineering businesses.

Responding quickly to the needs of the changing environment, we dug into the core of our strengths to harness the new opportunities and deliver positive growth in one of the worst years in recent history.

During FY 21, we have redesignated the 'Gears business' as the Power Transmission Business (PTB), which we believe to be a more accurate representation of our business profile in this segment.

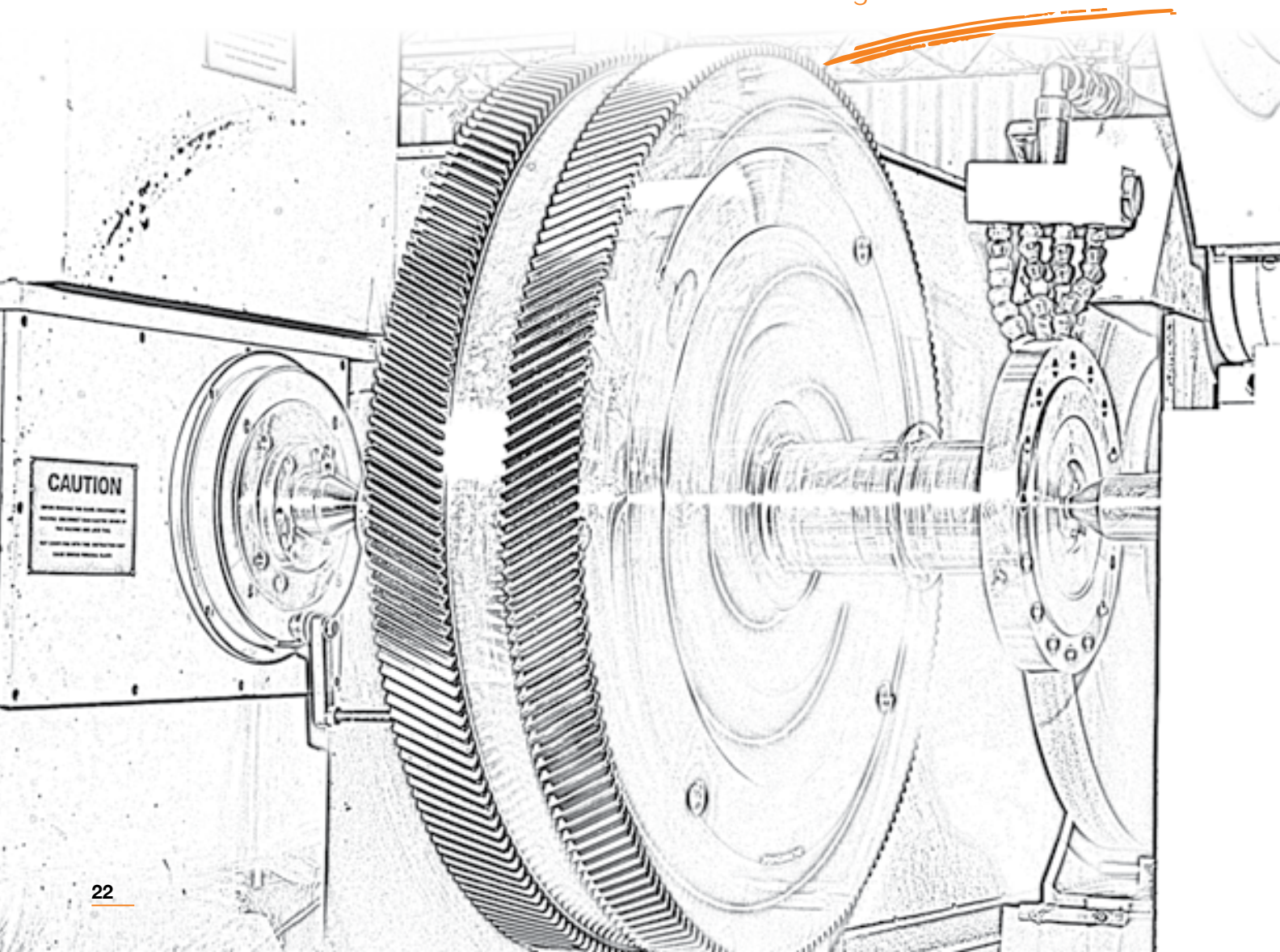

Amid the unprecedented COVID pandemic, Power Transmission Business completed 1,000+ global deliveries in FY 21

SEIZING TOMORROW'S opportunities today



Our ability to see beyond today's challenges, into the realm of future opportunities, enabled us to get our Engineering business quickly back on the track to normalcy after the total shutdown in the first quarter of the year. Undeterred by the slow order finalisation and even deferment in some orders amid the global crisis, we continued to reach out to new and potential customers across our business segments. Proactive planning and deployment of a variety of digital tools helped this business segment secure quite a few orders and commission quite a few gearboxes even amid the restrictions in place globally. Digitalisation became the new mantra of our business as we adopted online and automated tools to drive processes and enable a 360-degree customer service proposition. At the same time, we used this period to start exploring a variety of new product segments and geographies to further improve our turnover and profitability in the coming quarters and years.

New products

Hydro Gearboxes

Multiple configurations and across power range

Multistage mill gearboxes

Parallel shaft for Sugar, Steel, Rubber, Petrochemicals, etc.

Planetary Sugar mill drives

Test Rig Gearboxes up to 40 MW and 70000 RPM

Integrally Geared compressor gearboxes

Multistage and very high speeds

We successfully secured one EPC project of water sewerage (USD 22.80 million) from the Ministry of National Planning Housing & Infrastructure of Republic of Maldives, funded by Exim Bank of India, during FY 21, thus underscoring the robustness of our offerings.

Positive signs in negative times

As orders started picking up in the Power Transmission segment from the second quarter of the year, we focussed proactively on timely delivery of products and services to our customers across geographies, despite the constraints of continued lockdowns and travel restrictions in many countries. Our teams worked tirelessly to ensure expeditious and efficacious outreach to customers, to help meet their urgent needs and address their critical problems without undue delay or serious operational downtime. With more countries easing restrictions from the last quarter of the year, order finalisation in this business is expected to pick up.

The Water Business showed commendable performance despite the supply chain disruptions, and shortages of raw materials and labour, which impacted ongoing projects that resulted in time and cost overruns. We expect positive results in the coming months as a result of our continued participation in a large number of tenders during the year. The Government programmes like Atal Bhujal Yojna, Pradhan Mantri Krishi Sinchai Yojna, Namami Gange, Jal Jeevan Mission, etc. are also yielding desired results, and we continue to follow a participatory approach with the Government of India for long-term sustainability to make the country water-secure.

We are fully geared up to tackle issues relating to subdued activity in some of our new business opportunities by looking at new areas of growth. We also received strong enquiries in the Defence segment and are hopeful of concluding more orders in the year ahead.

In fact, we see a lot of new interest from a variety of sectors in both Water and Power Transmission segments. We are in the fortuitous position of making the most of the opportunities unfolding globally as companies are looking increasingly at reliable but lower cost options amid the pandemic, especially for engineering products.

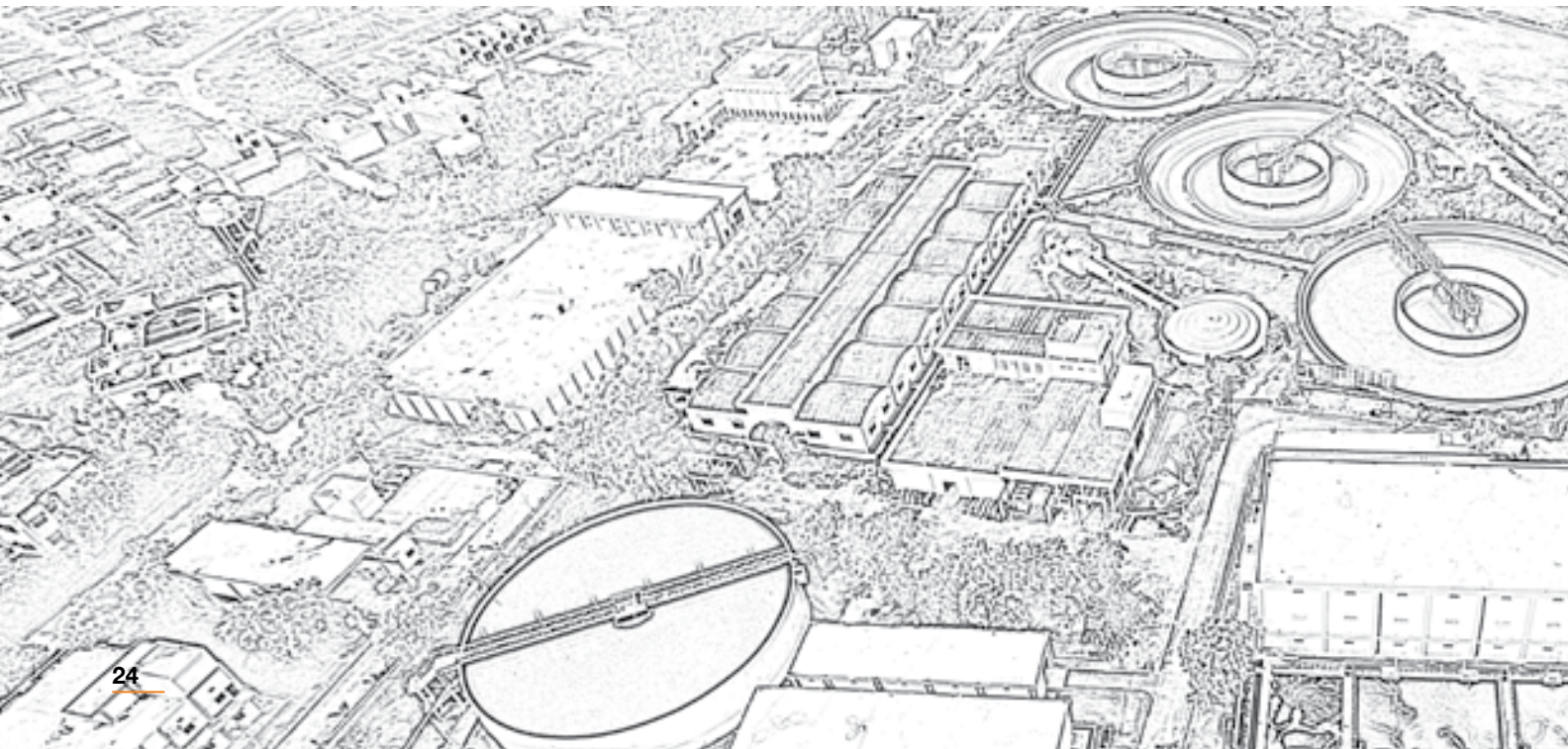

Performance Highlights - Power Transmission Business

₹ **130.08** Crore

Gross Revenue

₹ **40.91** Crore

PBIT

₹ **157.8** Crore

Order Booking in FY 21

₹ **166.23** Crore

Outstanding Order Book (including long duration orders of ₹ 66.63 crore, executable over couple of years)

Performance Highlights - Water Business (on consolidated basis)

₹ **260.7** Crore

Gross Revenue

₹ **26.7** Crore

PBIT

₹ **912.02** Crore

Outstanding Order Book
(Product & EPC)

₹ **456.87** Crore

Operations and Maintenance
Contracts Outstanding
Order Book

RESPONDING TO

Defence opportunities



The Indian Government is focussed on Atma Nirbhar Bharat, coupled with various initiatives and incentives to encourage domestic manufacturing and reduce its external dependence for its Defence industry. The Government has set a defence production target of USD 25 billion (including USD 5 billion from exports) by 2025. This augurs well for the Company, which is gradually expanding its presence in this segment at the back of its expertise and experience in the production of critical, high-quality, precision-led Turbo and other equipment. Given the huge potential for growth in this segment, we now plan to set up a large and dedicated multi-modal manufacturing, assembly and testing facility at Mysuru for rotary products. This will have 80-100 tonnes handling capability, in addition to high-precision test benches and a strong integration capability.

Business Profile **SUGAR**

An **EXCEPTIONAL STORY**

We are one of India's largest sugar manufacturers, with 7 state-of-the-art, Food Safety System Certification FSSC 22000 certified sugar units. Our integrated operations are designed to manufacture high-quality sugar, with the captive feedstock from the sugar units used to produce potable alcohol, fuel-ethanol & power.

In the sugar segment, our products include premium quality multi-grade (large, medium, small) crystal sugar, refined sugar and pharmaceutical grade sugar, for use across industries. We also produce raw sugar for exports, depending on the market dynamics. Besides fuel-ethanol and potable alcohol (Indian Made Indian Liquor), our Muzaffarnagar distillery is also being used to produce high-quality hand sanitizers under the GERM CARE brand.

Our manufacturing processes and products are certified for their exceptional quality, with our Refined Sugar benchmarked to International EEC II grades and Pharmaceutical Grade Sugar Quality being ICUMSA below 45, with no added sulfur.

THE INTEGRATED advantage

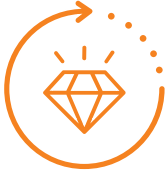

We use the co-products generated in the sugar manufacturing process to deliver value-added integration through our six power plants and two large state-of-the-art distilleries. Integration of our sugar operations with co-generation and alcohol production lends us a strong competitive edge. It enables us to boost operational and cost efficiencies, backed by stability. It also helps de-risk our product portfolio, with a footprint across diverse industries – Beverages, Food, FMCG, Pharmaceuticals, Confectionery, Oil & Gas, Alcohol.

Our Manufacturing Footprint

Our state-of-the-art manufacturing units, equipped with best-in-class equipment and streamlined processes, are located strategically in the sugarcane-rich belt of Uttar Pradesh (U.P.). The units are equipped with latest technological equipment and analytical labs to ensure the highest levels of product quality in a safe, healthy and clean environment.

We follow high EHS (Environment, Healthy, Safety) standards, with strict compliance to environmental norms, at all our facilities. Periodic EHS audits and investigation of EHS incidents, followed by immediate corrective and preventive actions, are integral to our operational strategy. Our manufacturing facilities are eco-friendly and zero liquid discharge plants, complying with ISO 45001 (Occupational Health and Safety Assessment series) and ISO 14001 (Environmental Management System) as per International Standard requirements. We have set up concentrated spent wash (termed as SLOP) fired incineration boilers at both the distilleries, in compliance with the Indian Government's new directives and guidelines for effluent treatment.

Sugar Production

Western UP

- 1 Khatauli (Refined Sugar)
- 2 Deoband (White Crystal Sugar)
- 3 Sabitgarh (Refined Sugar, Pharmaceutical Sugar)

Eastern UP

- 1 Ramkola (White Crystal Sugar)

Central UP

- 1 Rani Nangal (White Crystal Sugar)
- 2 Chandanpur (White Crystal Sugar)
- 3 Milak Narayanpur (White Crystal Sugar)

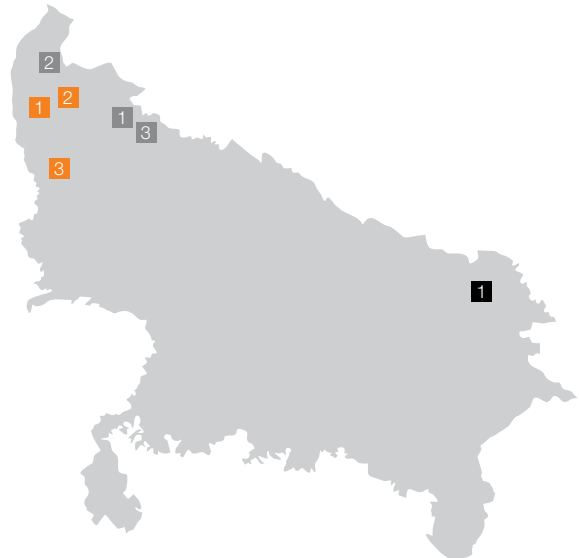

7

Sugar Manufacturing Units

FSSC 22000

Certified

61,000

TPD

Crushing capacity

Shagun

Branded sugar & other
food products

Distilleries

Muzaffarnagar (160 KLPD)

High-quality Fuel-grade Ethanol, Extra Neutral Alcohol (ENA), Potable Alcohol

320 KLPD
Distillation Capacity



Sabitgarh (160 KLPD)

High-quality Fuel-Grade Ethanol

92%
Ethanol Sales in Distillery product mix

GERMCARE

Hand Sanitizers manufactured at Muzaffarnagar distillery



IMIL (Indian Made Indian Liquor)

Produced at Muzaffarnagar distillery

POWERED FOR



long-term growth

We are operating three grid-connected large capacity co-generation plants and three smaller co-generation capacities (incidental co-generation facilities) at our five sugar units - Khatauli, Deoband, Chandanpur, Milak Narayanpur and Sabitgarh. The power thus produced helps us meet our captive requirements, while the surplus is exported to Uttar Pradesh Power Corporation Limited (UPPCL), with whom we have power purchase agreements for all our co-generation facilities. We use the latest Distributed Control System (DCS) at our plants, which are operated by highly experienced and skilled manpower. This helps us ensure trouble-free efficient operations with high uptime and reliable operations, along with very high operating efficiencies.

104.5 MW

Total Grid connected co-generation capacity at 5 sugar units

Excellence rooted in trusted relationships

Strong and deep-rooted relationships are at the core of our strategic approach in the Sugar segment. We have in place robust and close supply chain relationships with leading multinational Beverage, Food & FMCG and Pharmaceutical companies, as well as Confectionery producers. These help us ensure sustained business growth and value creation for our stakeholders. What really gives us a powerful edge in this business is our robust **Sugarcane Development Programme**, founded on our close relationships with our 3,00,000+ farmer associates, whose social and economic empowerment is an overarching commitment we have ingrained in our organisational value-system.

We share the confidence and trust of more than 3,00,000 sugarcane growers as a result of our innovative interventions and initiatives, which are continuously helping them enhance their livelihood and lifestyles.

EXPANDING Farmer Outreach

We engage closely with the farmers in our Sugarcane command areas, and work relentlessly with them to boost their farm yields. We incentivise and motivate the sugarcane growers to adopt the latest technologies and best practices. We provide them with high-yielding seeds, technological support, training and knowledge in best agronomic practices, to help increase their sugarcane yield and profitability. We teach them new techniques to nurture soil nutrients, improve cropping practices and ensure protection from disease. We support them through the cultivation and cropping lifecycle with continuous surveillance, real-time data capturing, as well as tools to control the cut-to-crush time. We also facilitate them in procuring high-quality and/or new varieties of sugarcane seeds, as well as pesticides and fungicides, on subsidised rates at our outlets.



Our Soil Health Programme is designed to help them assess the availability of macro and micro nutrients in the soil through planned collection of soil samples, followed by their testing and analysis at certified soil laboratories. Extension tools, such as pamphlets, wall paintings etc., are used to create awareness among farmers for balanced usage of soil nutrients. Based on the soil health status, we facilitate supply of macro and micro nutrients, including some on subsidised costs, through the agro input outlets at our units.

195K+

Hectare Area under
Sugarcane

300K+

Farmer Network

Business Profile

POWER TRANSMISSION

An EXTRAORDINARY STRATEGY

Our Power Transmission business (formerly known as Gears business) is focussed on delivering innovative, value-engineered, and reliable products and solutions in the areas of Gears, Defence and Built-to-Print. We are the largest manufacturers of high speed gears and gearboxes and a leading Turbo gears company, with a growing market share, especially in the South and SE Asian markets.

Led by sustainable business practices, we have emerged as the market leaders in high-speed industrial gears and gearboxes. We are the preferred partner to domestic and multinational Original Equipment Manufacturers (OEMs) in this business.

Our offerings in this segment encompass quality OEM supplies, replacement solutions, diagnostic studies and aftersales service. We deploy both Triveni Technology and License Technology (for select new high-power high-speed products) to deliver world-class solutions to our customers.



#1

In High-speed gears segment

>80%

Market share in High-Speed Gears in South & SE Asia

>10,500

Installations across the world

>50,000^{MW}

Globally installed gears capacity

1,000

Replacements of >80 global brands

Extraordinary multi-pronged strategy

Our strategic approach to steer sustained and sustainable growth in this segment is centred on the multiple pillars of:

World-class technology

to ensure premium quality with faster deliveries at an optimised cost for our products & services, with Industry 4.0 best practices followed at every stage.

Associations & tie-ups

with some of the leading global design houses, academic institutions and manufacturers, enabling us to provide world-class services/end products to our customers.

Automation & digitalisation

which we have embedded in our systems and processes, to help us embrace the new business ecosphere with speed and agility.

Cost management & efficiencies

ensured through fiscal prudence and optimal utilisation of resources, backed by efficient operations, to maintain business leadership.

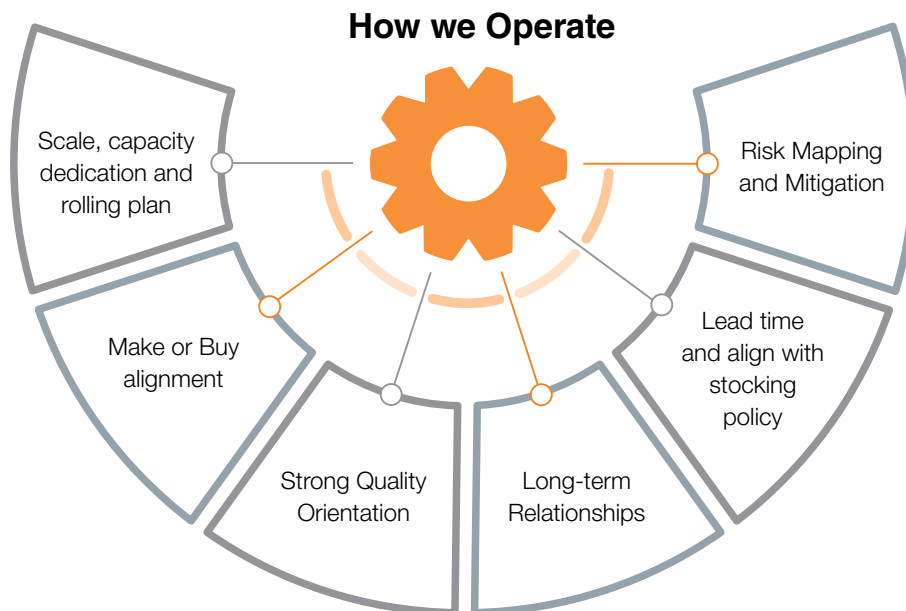

Our Product Offerings

Our product portfolio in the Power Transmission segment is structured to the diverse and varied needs of a large number of industries, and encompasses:

- High power & high speed gears designed for steam turbines, gas turbines, compressors, pumps, blowers, and other special purpose industry applications
- Niche low speed gearboxes for mini hydel turbines, steel mills, sugar mills, rubber mixers and extruders, cement mills, thermal plants, plastics etc.
- Marine offerings
- Replacement solutions

Our low-cost high-quality supply base has given us a powerful strategic edge in ensuring long-term relationships across the supply chain.

Our Prime Movers

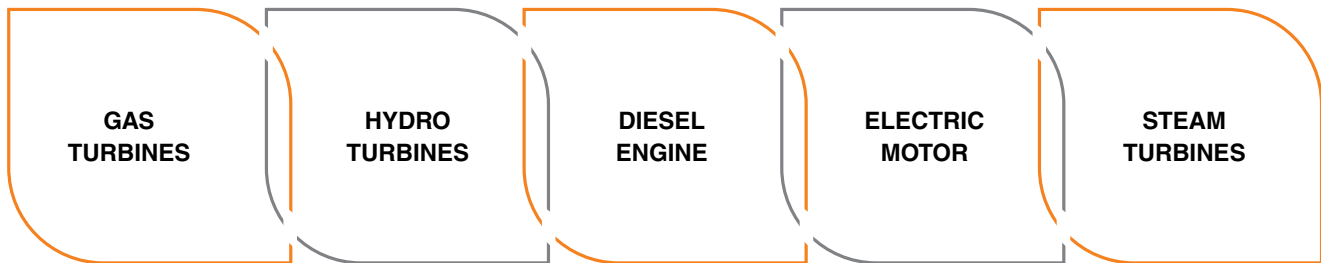

Industries We Serve Globally

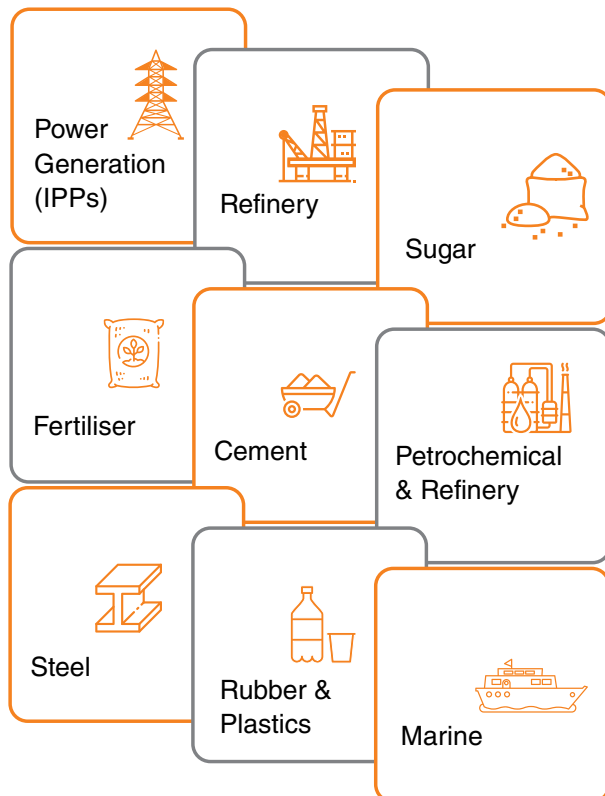

THE TRIVENI excellence chain

- All raw materials like forgings and castings developed to required stringent quality standards
- Materials for forgings restricted to approved steel mills meeting AMS 2304
- SOS delivery in carburising grade or through hardened material forgings from 10 days to 3 weeks, normal delivery in 4 to 6 weeks
- Deliveries for Grey Iron castings in 4 weeks with wooden patterns developed for majority of models
- Hydro dynamic radial journal bearings locally developed, tilting pad bearings from local/international sources
- Other bought out parts like pumps, clutches, RTDs, etc. from known local or international sources
- Barring gear units assembled by Triveni with all locally developed parts
- Product delivery cycle ranging from few weeks to 6 months for full gearboxes

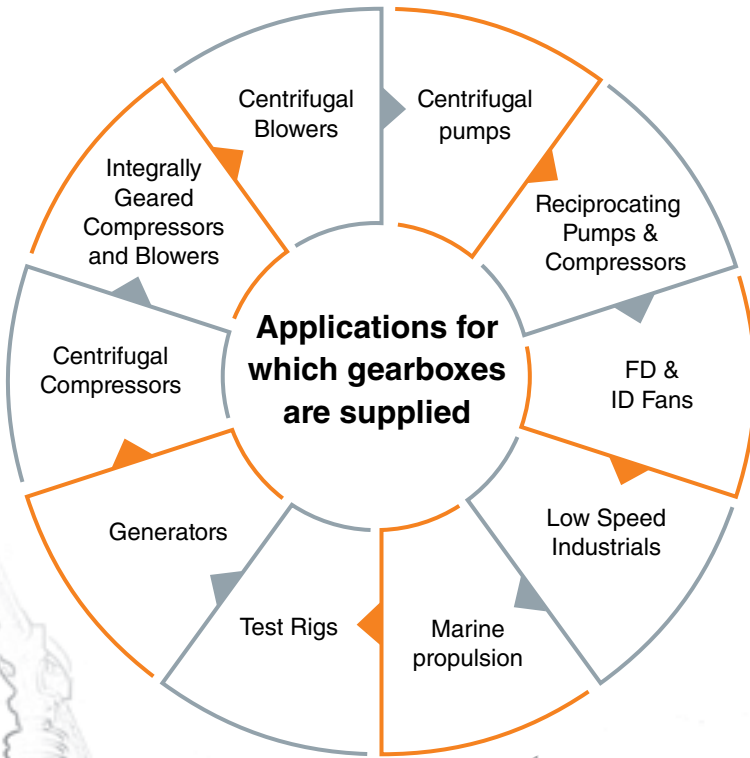

Centred on Operational Excellence

Our fully integrated plant in Karnataka is equipped with state-of-the-art infrastructure and all critical operations in-house, thus enabling tight control on quality across the value chain. The facility, spread over 10.5 acres facility, houses our Design, Manufacturing & Quality Control functions.

Our manufacturing systems are completely integrated, with in-house core processes up to 2 metre diameter and in-house heat treatment facility. The plant is equipped with world-class cutting edge machinery, including: Latest profile grinding, hobbing, horizontal and vertical grinding, horizontal boring & plano milling machines from leading global companies.

The layout is designed for minimum material movement (overall 6 bays). There are separate bays for gears, shaft machining/cylindrical grinding & casing machining. There is a Heat Treatment bay as well as Organised Assembly bay with multiple workstations and 3 test benches. An in-house standby power generation – 2 MW, ensures uninterrupted operations.

QUALITY FIRST

& foremost



To ensure sustained operational excellence, we adhere to stringent quality standards at every step of the value chain. Adherence to best-in-class global QC standards ensures long-term relations with a growing global customer base, with all our products and processes benchmarked to global quality practices and 5S principles. All our business processes are on SAP.



Certifications:

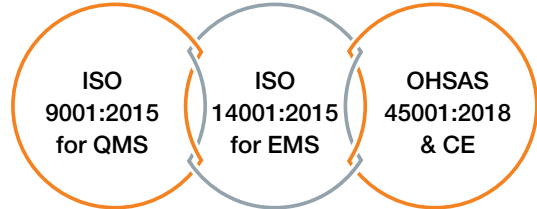

The Triveni Design Edge

With our strong core of skilled manpower, technical expertise, robust Research & Development (R&D), we deliver products that are designed as per API, AGMA, DIN, ISO and other international standards. Our design edge is steered by a large technology team to support our Engineering, NPD and R&D programmes. Reliability is ensured through best engineering practices, while proximity facilitates our ETO business. We leverage our relationships with technical universities and specialised design houses to deliver exceptional innovation-led offerings.

Our design centre is equipped with:

51 workstations with CREO 3D software for modelling & drawings, Windchill for data management

Analysis software XL Rotor for Rotor Dynamic Analysis and Ansys for Structural analysis

Machine design calculation software Triveni Suite, KISSsoft, Journal Bearing design software HydroDyn

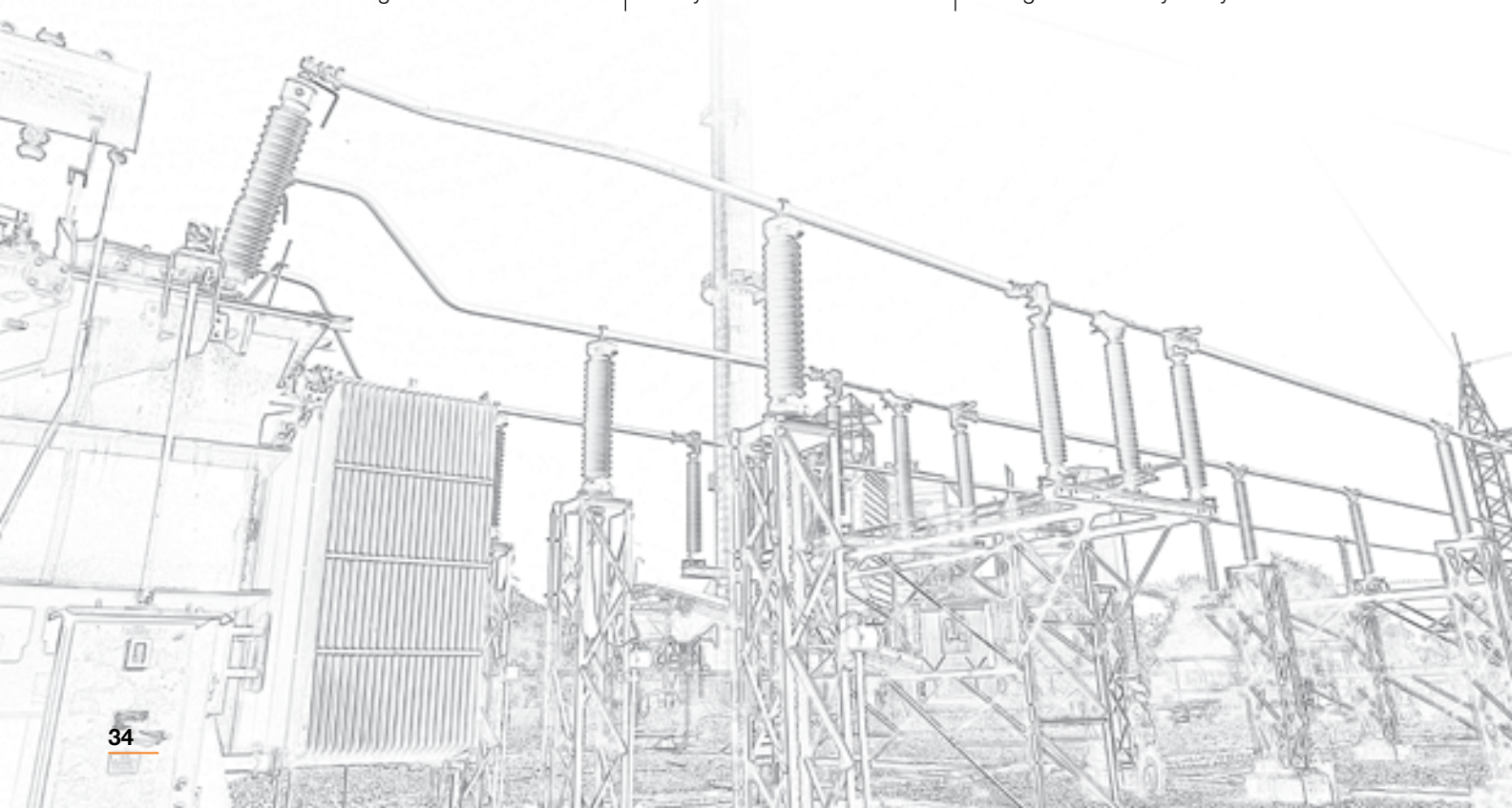

Precision-led Reverse Engineering proposition

We leverage our expertise and experience of over 25 years to offer precision-led products and services for repair of gears and gearboxes to customers across industries. We provide them with customised solutions, not just of gears/gearboxes of our own make but also of other makes.

Our complete range of high-quality repair and replacement solutions includes:

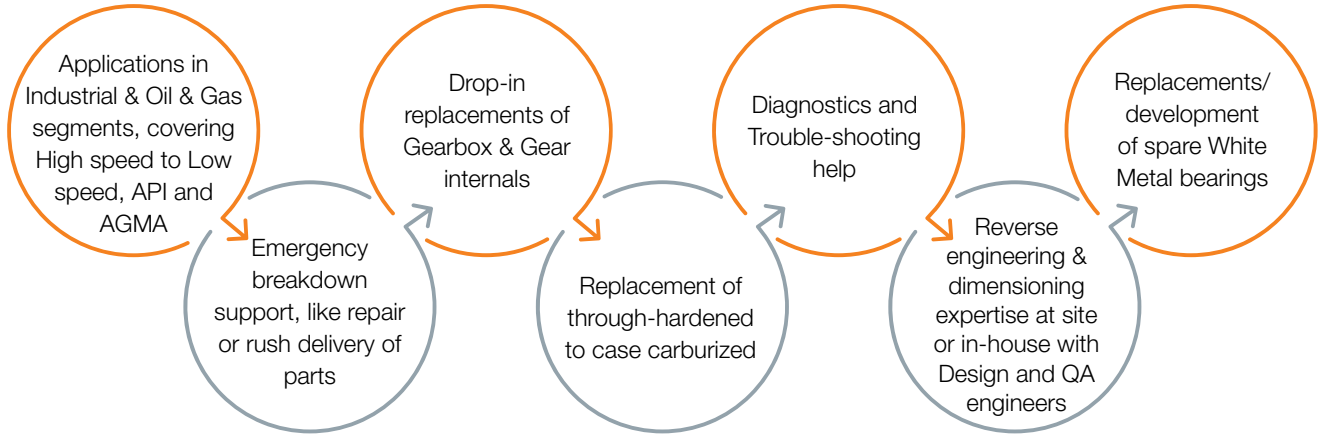

API EXPERIENCE & capability

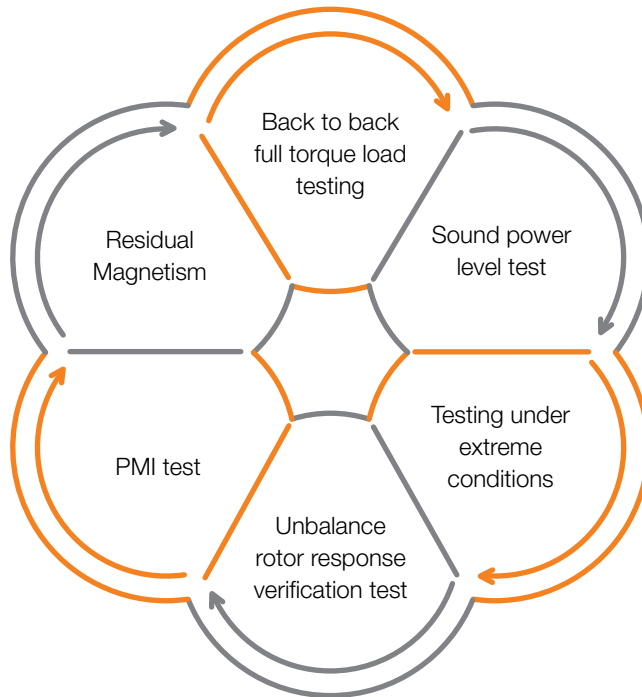

Business Profile

DEFENCE

An EXCEPTIONAL VENTURE

Our smart and reliable defence solutions, provided through the Triveni Defence Business - a strategic business unit of Triveni Engineering & Industries Ltd., are designed to support India's safety and security network. The Triveni Defence Business is an OEM for a host of important products for the Indian Navy and Indian Coast Guard.

We are today a trusted and reliable supplier for the Indian Navy, and also an approved supplier for the Indian Coast Guard and registered with the Director General of Quality Assurance (DGQA) – a reflection of our technological and innovation prowess. The Indian Navy has chosen Triveni as its reliable supplier of the Turbo Alternator Turbines (TAT) and turbo pumps, under its coveted Indigenous submarine programme. As part of this relationship, we are providing refurbishment, reverse engineering and fully indigenous solutions for the turbo-auxiliaries of steam ships of the Indian Navy.



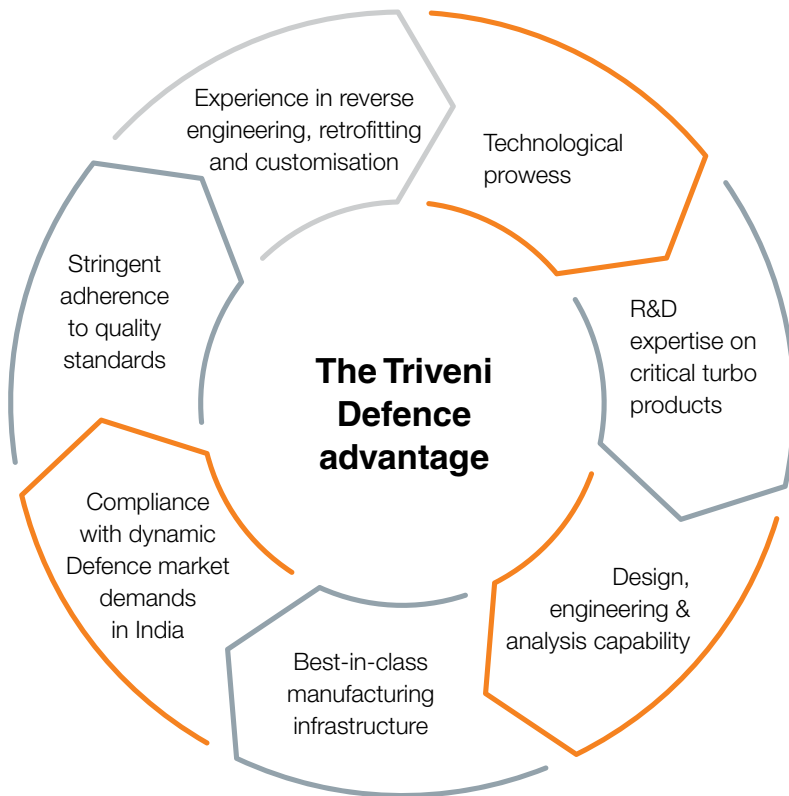

In the Defence segment, we have partnered with the Government of India in the realisation of its vision for 'Atma Nirbhar Bharat' (Self-Reliant India).

Our Defence Product Portfolio

Propulsion Gearboxes and other critical gearboxes

Critical Turbo and Motor-driven Pumps

Gas Turbine Generators for auxiliary power

Steam Turbines to complex Turbo-Auxiliaries

Fin Stabilisers



In the pipeline

Propulsion
Gas Turbines
Packages

Propulsion
Shafting

Indigenous
Packaging of
propulsion gas
turbine

Propulsion
System
Integration

Application
based EPC
solutions

Solutions
for Steering
Systems /
Stabilisers

Aftermarket Services & Repair

**Our precision and quality driven
aftermarket services in this segment
include:**

- Diagnostic and Troubleshooting assistance
- Technical assistance on call
- Emergency Breakdown Support
- Overhauling
- Refurbishment of Rotary equipment such as Turbines, Turbo-auxiliaries, Gear Boxes etc.
- Drop-in replacements of Marine Gearboxes and Gearbox internals
- Complete Turbine / Turbo-auxiliaries drop-in replacements
- Reverse Engineering and Dimensions on-site or in-house, with Design and QA engineers
- Replacement / Development of spares and Supervising the dimensioning activity for development of spares
- RLA – Remaining Life Assessment
- Round-the-clock waterfront support and Annual Maintenance Contracts for select Rotary equipment

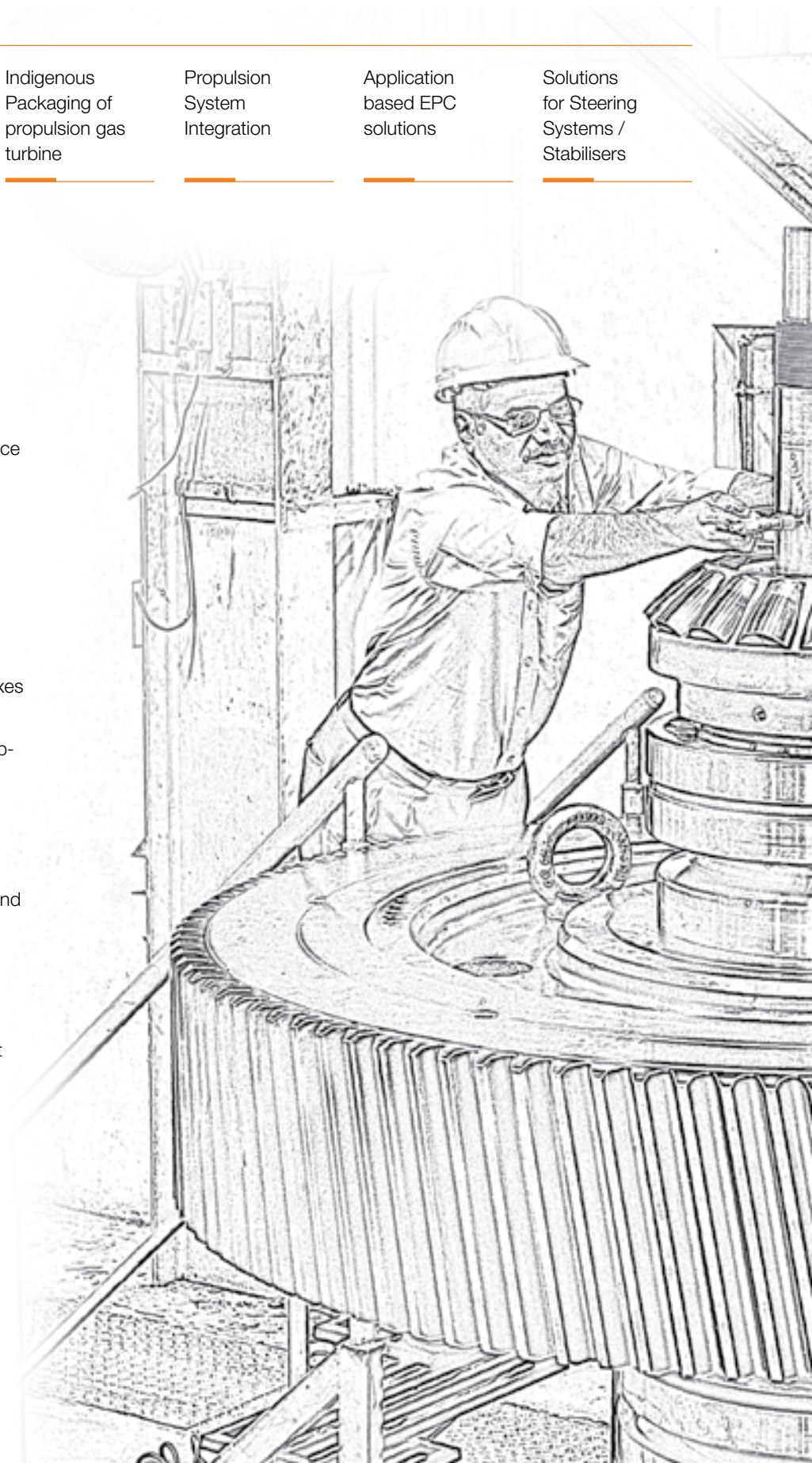

Manufacturing Excellence

Our state-of-the-art manufacturing facilities, spread across Mysuru and Bengaluru, are well equipped for the production of technologically superior products for the Indian Defence and Aerospace sector. The facilities are equipped with the most advanced world-class multi axis CNC machinery and equipment handling capacity of 80 tonnes.

Quality Assurance

We ensure stringent product quality through adherence to the highest standards through a 3-edged framework:



Our quality quotient is endorsed by:

ISO

OHSAS

ABS

AS9100D

Business Profile

WATER

An EXTRAORDINARY OUTLOOK

Inspired to foray into this segment by our visionary perception of the future, we are today one of India's largest providers of efficient, sustainable and complete water/wastewater treatment solutions, across the water cycle. Our focus is on delivering customised and sustainable futuristic solutions, aimed at addressing the growing shortage of the water resource.

We offer innovative solutions designed to meet the specialised needs of industrial, municipal and specialised projects across sectors, including desalination project solutions and urban utility management for Water & Sewerage Network. Our end-to-end Turnkey / EPC offerings deliver optimal life cycle cost across all the sectors. In the municipal sector, we also offer projects on Build, Own, Operate, Transfer (BOOT) model for industrial/municipal sectors, and additionally on the Private Public Partnership (PPP) option.

>1,200

Successfully operational
installations across segments
pan India

~10,000 MLD

Water & Wastewater treated
through Triveni projects

2,000+

Process equipment supplied
& commissioned

400+

Full-time employees

We are the preferred partner for an increasing number of customers looking for optimised and reliable solutions. Even our major EPC competitors are opting for purchase of high-quality Triveni process equipment.

The Triveni competitive edge

We have some of India's biggest projects to our credit, which we have delivered successfully at the back of our strong project management skills, in-house capabilities, advanced technologies and innovation, expertise in pre-treatment processes. We have technology associations with the world's leading technology providers for various products, processes & solutions. To meet the niche requirements of customers in this highly specialised business, we adhere to the most stringent specifications in our products and solutions, which are endorsed by our various certifications and accreditations. We have also won many awards in the Water segment for Innovative project designs.



Portfolio of value-engineered solutions

Driven by innovation and technological expertise, we have developed a complete range of advanced turnkey/EPC water management solutions on optimal Life Cycle cost basis comprising:

- Water treatment (Raw, Process, Desalination)
- Wastewater/Sewage treatment
- Recycling & zero liquid discharge
- Water & wastewater network management
- Hybrid Annuity Model (HAM)
- Water treatment plants
- Water/Wastewater Sludge treatment and management
- Bio gas system with power generations
- Oil Water separation

We also undertake such projects on PPP/DBOOT/BOOT models basis

Value-added services

With our focus on providing end-to-end services to customers across sectors, we also offer value-added services, including aftersales and operations management.

- Product & process audit, project health check-up, assessment of existing processes
- Modification of process to meet new Effluent Standards
- Rehabilitation of old plants/equipment
- Process Equipment for physical separation, Biological treatment, Sludge treatment, Sludge digestion, Biogas handling, Tertiary level treatment including Membrane filtration etc.
- Refurbishment, upgradation, automation of existing plants
- Operation & Maintenance
- Annual maintenance contracts
- Piloting & field trials
- Spares, service consumables, chemicals
- On-site training & assistance

With our effective and customised O&M services, we help customers ensure operational optimisation. This helps them achieve considerable energy savings, besides enabling them to defer replacement of expensive mechanical equipment. We also facilitate them with asset management to minimise, or in some cases even eliminate, plant shutdowns. This ensures uninterrupted operations, which also helps in extending the life of mechanical equipment.



Our value-added services are designed to cater to customer needs for Process Upgradation, Rehabilitation, Refurbishment, Operations & Maintenance (O&M).

Cutting-edge equipment

Advanced equipment supported by cutting-edge Aerobic/Anaerobic technology gives us the operational edge needed to ensure efficient, timely and cost-effective solutions to our growing clientele in this business.

Our technology edge is manifest in:

- Activated Sludge Process (ASP)
- Anaerobic / Anoxic / Oxidic (A2O)
- Moving Bed Bio Reactor (technology arrangement with Aqwise of Israel)
- Sequential Batch Reactor (technology arrangement with GAA of Germany and Premier Tech of Canada)
- Conventional and Membrane-based Filtration (UF/NF/RO/MBR)

A snapshot of our equipment

Intake Works

Physical Separation Units

Oil Water Separators

Biological Treatment Units

Sludge Dewatering Units

Post Treatment & Polishing (Media-based, Membrane-based, Resin-based)

MATHURA



Wastewater Project

Mathura Wastewater Management Project

As a leading company undertaking PPP/HAM projects, we are executing this project for Mathura city on HAM mode through our wholly-owned subsidiary 'Mathura Wastewater Management Pvt Ltd'. The project is under one-city-one-operator model of Namami Gange programme and will manage entire city's Wastewater (Sewage) to augment city's sanitation management as well as contribute for cleaning the river Yamuna flowing through the city.

Key components of the project include state-of-the-art Tertiary level plant with Ultra-filtration cum Reverse Osmosis (UF-RO) for treating wastewater for process water needs of Mathura crude oil refinery of Indian Oil Corporation Ltd (IOCL).

Other key components of the project include rehabilitation and upgradation of the existing assets, capacity addition to augment for city's wastewater treatment requirements, addition of interception and diversion measures for various drains of the city to the treatment plants under the project, etc.

After completion of the Capital works of the project, we will operate & maintain (O&M) the facilities for 15 years on end-to-end basis.

MESSAGE FROM THE CHAIRMAN



Dear Shareholders

FY 21 presented enormous and unprecedented challenges with the continued onslaught of COVID pandemic. In spite of the various impediments, your Company delivered a robust performance, driven by an extremely proactive approach to crisis management. Responding dynamically to the transforming external environment, we moved with exceptional agility in our continued pursuit of excellence across all our businesses. While our Sugar and Alcohol businesses crossed new operational milestones, we leveraged our digital prowess in the Power Transmission business to stay connected seamlessly with our customers amid a highly challenging environment. We worked closely with the Central and State Governments to enable a safe operating environment on resumption of business after COVID-led lockdown in the first quarter and during restrictions in subsequent quarters.

As we stayed on course to ensure business continuity, we did not lose sight of our responsibility towards our employees, our farmer associates and our supply chain partners. Ensuring their safety and security became a key priority for the Company and we moved swiftly to put in place stringent safety protocols and policies, which all stakeholders were required to strictly adhere to, both at plants and offices. We also strengthened our Corporate Social Responsibility (CSR) framework to equip the communities around our manufacturing facilities with the necessary tools to effectively combat the pandemic threat.

I strongly believe that our well-structured response to the unprecedented crisis helped us drive a positive performance during the year. Coupled with our operational efficiencies, the drive and focus of the organisation enabled us to bounce back with speed and efficiency. This responsiveness was evident in the extraordinary pace with which we moved into the production of hand sanitizers after

deciding to make this strategic foray to support the Government of India's efforts to tackle COVID.

The Alcohol business remained a key driver of our growth and a major contributor to our Sugar business performance during the year. Our entry into the manufacturing of Indian Made Indian Liquor (IMIL) also reflected our commitment to sustained and continued growth and expansion, notwithstanding the calamitous effect of COVID on industries and businesses worldwide.

The Company has ranked second in the country in terms of sugar production in SS 2020-21. We also reported strong distillery performance in terms of both production and sales.

After witnessing severe hardship over the years which led to erratic production, high cane arrears and pricing instabilities, the Sugar industry is now moving towards consistent performance with more transparency and clearer policy directions, which will augur well for the business going forward. The Government policies are also dynamically fuelling growth and expansion in distillery operations, with the Government of India's announcement of acceleration of the 20% blending of fuel ethanol with petrol, target to 2025 promising increased buoyancy in the business. This move aims to address the twin problems of evacuation of excess sugar stock and dependence on crude oil imports, as the country prepares for a holistic energy transition by focusing on renewables.

With our strong expertise and extensive experience, we are fully geared to harness this growth opportunity. The Board has approved expansion of distillation capacity of the existing and upcoming distilleries located at Muzaffarnagar (UP), Milak Narayanpur sugar unit at Distt Rampur UP and Sabitgarh Distt Bulandshahar (UP), subject to receipt of necessary statutory clearances, raising total distillation capacity from 520 to 660 KLPD at an aggregate cost of ₹ 100 crore (approx.) through low capital cost incidental expansion / debottlenecking through internal accruals. Such expansion will be completed before the commencement of the SS 2022-23. We are also looking at our Alcohol business, through which we

entered IMIL production during the year under review, to steer our plans to expand into new areas of potential growth.

On the Power Transmission front, there was a decline in the turnover due to the impact of the COVID restrictions but the order booking was largely maintained. Stabilisation of business conditions in the last quarter of the year, and improved profitability of the Water business due to efficient project execution and project cost savings, mitigated the losses in this segment to some extent. This was the outcome of the digital initiatives launched by the Company to sustain business operations and ensure customer engagement. The total outstanding order booking for the Engineering businesses is robust, at ₹ 1,078.25 crore and we are positive about their long-term prospects.

Apart from the traditional OEM and Aftermarket segments, the Power Transmission business is also focussing on Defence under the "Make in India" initiative. During the year, we secured approvals for new projects and for refurbishing requirements in the Naval Defence space, which is expected to translate into orders for the Company in the coming quarters. Additionally, the Company has partnered with global OEMs for precision manufacturing of components for wind gearboxes as well as industrial high-speed compressor gears. These initiatives are likely to throw open several opportunities for growth in the medium term.

In the Water business, severe water shortages across the globe have led to major concerns and accelerated projects towards conservation and overall management. The World Economic Forum continued to rank water crisis (natural resource crisis) amongst the top-5 risks in terms of impact in its Global Risk Report 2021. This issue is further exacerbated in a country like India where a significant percentage of population does not have access to clean water. The Government of India's impetus with programmes such as Jal Jeevan Mission, Namami Gange, etc. have been providing and continue to provide more opportunities in water/wastewater treatment segments. While there were setbacks in the last year due to COVID, we believe with

the large number of tenders that the Company has participated in the Water segment during the year will also yield positive results during the course of year and beyond. Overall new projects and tendering activity is also expected to improve as things stabilise in the country. At the same time, we are exploring new products and geographies for expansion, in order to further improve our turnover and profitability. I am happy to report that, this year, we managed to secure the first international order for providing water treatment to around 10,000 people in the six islands of Maldives.

Amid this positivity, one thing that really stands out is the resilience of our people, who were the pivot of our efforts to keep our business plans and performance on track in an extremely tough environment. Once business operations started normalising, they responded with extraordinary nimbleness to support the Company in the realisation of its goals and targets, and continue to inspire us to scale new horizons of progress in our onward journey. On behalf of the Board and the Management, I would like to express my gratitude to our people and assure them that the Company will continue to stand with you and your families in these difficult times. We also remain committed to further augmenting our CSR efforts to reach out impactfully and meaningfully to the most vulnerable sections of the community, who have been the worst affected by the pandemic.

In conclusion, I would like to mention a special word of thanks for all our customers, partners, vendors, investors, shareholders and other stakeholders, whose sustained support continues to be a vital engine of our future growth. I am confident that, having emerged stronger through the COVID experience in many ways, we shall successfully employ our learnings of the fiscal under review to propel greater growth and accretive value for our stakeholders, as we move forward.

With best regards,

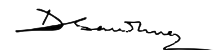

Dhruv M. Sawhney

Chairman & Managing Director

Q&A WITH VICE CHAIRMAN & MD

Tarun Sawhney, Vice Chairman & Managing Director



“

Our sustained focus on Ethanol continued to steer growth in the Alcohol business during the year, with strong growth of 14% and 23%, respectively, in distillery performance on production and sales.



Q.1

How was the Company's performance this year despite the COVID-pandemic?

I am happy to share that we have performed fairly well, given the circumstances. Gross revenue for the year stood at ₹ 4,703.35 crore and Profit after Tax at ₹ 294.61 crore (on consolidated basis). This is quite an achievement, which was made possible due to a highly judicious and prudent approach, which the Company has been following for the past several years. Amidst the new challenges, we were able to both, devise new ways of

working for all our businesses and also rise to the opportunity to contribute, to the greater national cause through production of sanitizers and using our existing facilities and expertise to sensitize, educate and protect the hundreds of thousands of people we interact with on a daily basis. In a tough year like this, having a strong balance sheet like ours has also contributed to the overall performance.

Sugar and Alcohol businesses have been the biggest drivers of our largely positive performance amid an extremely challenging environment. We have reported a high sugarcane crush and sugar production in SS 2020-21 in terms of the state average – an endorsement of our deep-rooted strengths in this business, as well as our robust sugarcane development programme. Our recovery, however, declined by 11 basis points on a comparable basis, excluding the impact of B-heavy molasses, as compared to the previous sugar season due to heavy water-logging and red rot disease. Our sustained focus on Ethanol also continued to steer growth in the Alcohol business during the year, with strong growth of 14% and 23%, respectively, in distillery performance on production and sales.

Our gains in the Sugar business somewhat negated the lower revenues in the Power Transmission business, which reported over 15.65% decline in turnover and 15.7% in Segment Profit. However, even in the tough environment, we secured several orders for supply of compressor gears and gearboxes from India and overseas customers, which we believe will translate into good growth going forward. In the Water business, the Company has participated in several bids during the year and we feel positive about securing more orders when the order finalisation starts.

Q.2

How did you manage the workforce challenges amid the pandemic situation?

Ensuring the safety and security of our employees and our supply chain partners (the sugarcane farmers) was a big challenge. We put strict safety protocols in place at the mills, the plants and the cane outlets, which our people as well as the farmers and other visitors had to strictly adhere to. Wearing masks, temperature scanning, maintaining social distancing, installation of touchless dispensers was some of the key measures undertaken at all facilities and offices. We also distributed masks and sanitizers to the communities around our plants as part of our CSR outreach.

We went touchless in 72 hours post the announcement of lockdown. As far as managing customer relations was concerned, digital tools were employed in a major way to respond to customer needs in a timely manner, given the travel restrictions worldwide. We also introduced remote testing and monitoring techniques to enable customers to see their products undergo precision testing of gearboxes without having to visit the site. While introduced during pandemic times, given that many of these measures have garnered a positive response, we are now incorporating them into the normal course of business, which will help us deliver a seamless customer experience.

Q.3

What are the major factors that enabled you to stay on course of performance excellence, and steered your growth trajectory during the year?

Our diversified portfolio across business segments, coupled with our focussed

efforts to continuously improve operational and cost efficiencies, has been a key driver of our performance consistency. Innovation has been at the heart of our growth strategy across businesses over the years, and we have continually enhanced our systems and processes by embracing the latest technological and digital advancements.

In the Sugar business, this thrust has helped us strengthen our sugarcane development programme year-on-year, thus ensuring high yielding and high-sucrose sugarcane varieties to augment the volumes of sugarcane crush and improve sugar recoveries. In our distilleries business, backed by a favourable Government programme, our innovative efforts are enabling optimal capacity utilisation and performance, with our judiciously balanced production mix of B-heavy and C-heavy molasses and its utilisation in our distilleries which is helping us maximise our revenues in this business. During the year, the production increased 14% y-o-y to 107,027 KL, 56% of which came from B-heavy molasses v/s 34% in the previous year.

We are continuously sharpening our technological expertise in our Power Transmission and Water businesses too, making us a preferred choice for a growing clientele across regions.

Another major propeller of our growth strategy is our strong customer-centric approach, which we are focussed on continually enhancing through our deep understanding of their evolving aspirations and mapping of the marketing trends. Product quality is ensured in line with customer expectations, while our efforts to power sustainable growth through environmentally responsible operations also continues to steer the positivity of our performance. During FY 21, we further pushed the bar of our expertise to meet the unparalleled challenges of an extremely tough environment.

Q.4

The Company once again delivered strong performance in its Sugar operations despite some supply chain issues. What were the drivers of this performance?

I believe it is our concerted thrust on managing efficiencies through continuous improvement in reducing the product cost that helped deliver a good performance during the year. There was a trend of widespread decline in crush and recovery in U.P. for the SS 2020-21, mainly due to climatic factors, but the Company has experienced marginal decline, much less than that of the average of the State. We crushed 8.54 million tonnes of sugarcane, with a recovery of 10.98% (gross recovery: 11.86% after adjustment towards B-heavy molasses).

Our sugarcane development programme, through which we are partnering 3+ lakh farmers in boosting sugarcane yield and thereby production, remained a major driver of our growth and profitability in an uncertain environment. Our judicious product mix has also enabled us to keep growth on track, with stable sugar prices further contributing to the performance. The Company continues to actively pursue sugarcane variety substitution programme to gradually reduce overdependence on the star variety Co-0238.

Our active engagement in sugar exports under the Government of India's MAEQ scheme has also helped in keeping our numbers in the green in this business.

Q.5

There seems to be a lot of positivity on the sugar exports front. What does it mean for the Company?

Despite a delay in the announcement of the export programme by the Government of India, the industry

has responded quite well, with robust international pricing helping the industry in contracting significant quantity of sugar in a short period. The Government announced allocation of export quota of 6.0 million tonnes to all sugar mills on December 31, 2020, with export date till September 30, 2021. Favourable international sugar prices driven by muted production outlook in countries like Brazil, Thailand, etc. have led Indian mills to export sugar even without subsidy, and the country is estimated to export 7 million tonnes of sugar this season, i.e. 1 million tonne higher than the subsidised volume.

It also notified an assistance scheme for the mills to meet their marketing costs, including handling, upgrading and other processing costs, along with costs of international and internal transport and freight charges on export of sugar. Our total sugar quota for exports under SS 2020-21 MAEQ scheme was 1.82 lakh tonnes and the entire quota was contracted, of which 1.03 lakh tonnes was physically despatched in FY 21.

The Government of India has given a lot of flexibility on evacuation of the sugar, which is helping us contract our export quota effectively.

We see a substantial demand for sugar in the eastern hemisphere, with India securing relative premiums over New York. This augurs well for the Company, as it will facilitate us in making timely payments to farmers for sugarcane purchased. With the Government allowing supply of sugar to refineries in Special Economic Zones (SEZs) to be considered as exports for availing certain benefits under the MAEQ scheme, we see the Indian sugar industry gaining further in the coming quarters in terms of price stability. Given these opportunities, we aim to focus on enhancing exports with expansion into new geographies.

Q.6

The Company reported lower sugarcane crush and recovery. What is the reason behind this?

Unfortunately, Uttar Pradesh witnessed a climatic flux that led to decrease in sugarcane yields and sugar recovery, especially in the eastern part of the state, which was impacted by extreme waterlogging that led to crop destruction. Eastern and Central UP were also impacted by the red rot, which caused damage to crops, causing sugarcane crush to come down marginally as compared with the previous season. Another factor that has impacted recovery is diversion of sugar in B-heavy molasses for ethanol production, which was a strategic decision we took to ensure adequate feedstock availability for our distillery units. This resulted in increase in quantity of sugar diversion over the previous season. Cumulatively, these factors have led to a decrease in recoveries at all our units.

Q.7

You have taken several new initiatives in the alcohol business during the year. What is the rationale behind this expansion? Do you see a lot of growth happening in this business going forward?

The Government of India's policy initiatives and positive signals on ethanol blending are contributing significantly to stabilising the country's sugar industry. While the Government benefits from savings on the import bill on crude imports and environment protection, sugar mills get the advantage of an avenue to divert excess sugar production, opening up an additional revenue stream for them. Sugarcane farmers also benefit owing to the improved profitability of the sugar operations.

The Government is also incentivising mills to set up distilleries, besides increasing ethanol prices – which makes ethanol production an attractive proposition. The Government's modified scheme for financial assistance by way of interest subvention is expected to boost investment in distilleries, which will enable the country to fast-forward towards the accelerated goal of 10% blending by 2022, and 20% to be achieved by 2025.

At Triveni, we are harnessing these opportunities to continuously scale up our ethanol production to earn more revenue from existing distilleries while also investing in new distilleries. During the year, the production and sale in the Distillery segment recorded strong growth in view of full year impact of the new distillery. The Board of Directors has approved two new distilleries – at Milak Narayanpur (160 KLPD, sugarcane juice, syrup/grain based) and Muzaffarnagar (40 KLPD grain based), to augment our ethanol and ENA production as per market requirements. The Board has approved expansion of distillation capacity of the existing and upcoming distilleries located at Muzaffarnagar (UP), Milak Narayanpur sugar unit at Distt Rampur UP and Sabitgarh Distt Bulandshahar (UP), subject to receipt of necessary statutory clearances, raising total distillation capacity from 520 to 660 KLPD at an aggregate cost of ₹ 100 crore (approx.) through low capital cost incidental expansion / debottlenecking through internal accruals. Such expansion will be completed before the commencement of the SS 2022-23.

Further, we have forayed into production of IMIL at our existing Muzaffarnagar distillery to enter the IMIL market. This forward integration of our distillery operations will give us the benefit of value addition to ENA, while also helping us reduce our obligation to supply molasses at a lower than market price to other IMIL manufacturing units.

The Company has received an approval to process ENA up to 52.8 lakh litre for manufacture of IMIL, and it has plans to increase the capacity up to 3.0 lakh cases per month in phases.

Q.8

The degrowth in turnover and profitability in the Power Transmission business during FY 21 is a matter of concern. Do you see the situation improving in FY 22, especially given the lockdowns and other restrictions due to the second surge of COVID at the start of the year?

The Power Transmission business was hit hard on account of delays, travel restrictions, plant closures/partial operations, migration of labour etc. Revenue of ₹ 130 crore and PBIT of ₹ 40.91 crore marked a decline of 16% and 16%, respectively, on a year-on-year basis. Though business did start picking up towards the second half of the year, the overall numbers for FY 21 were below our expectations. The segment reported contraction in orders from Domestic OEMs by 10%, partially due to the pandemic impact and partly due to the sudden increase in steel prices. However, even amid this negative environment, we reported a somewhat higher total order booking, with our products exports order booking going up by more than 200% over the previous fiscal. This was the outcome of our strategic investments and digital initiatives, which we scaled manifold to maintain business continuity and customer connect during the year. We have secured several orders for supply of compressor gears and gearboxes from India and overseas customers, which will translate into good growth going forward. We also received orders for Flue Gas Desulphurisation (FGD) blower application from domestic OEMs, offering good growth potential in the



Revenue of ₹ 130 crore and PBIT of ₹ 40.91 crore marked a decline of 16% and 16%, respectively, on a year-on-year basis.

coming quarters. The outstanding order book as on March 31, 2021 stood at ₹ 166.23 crore, including long duration orders of ₹ 66.63 crore, executable over a couple of years.

A total of six new OEMs were added to our customer portfolio, while in the aftermarket segment, exports grew by 25% during the year, mainly on account of our innovative edge and service orientation, which has enabled us to retain customers and grow business through existing relationships. Our Built-to-Print business contributed significantly to the higher order booking from the overall exports during the year. We are partnering with global OEMs for precision manufacturing of components on Built-to-Print basis, which will contribute to growth in this segment in the coming quarters. We also expect good growth from our new segment of compressor gears in both, the domestic and export markets.

Going forward, we see positivity in the Power Transmission business in the key sectors of steel, power, cement, telecom, coal and mining, where favourable Government policies are driving increased spending.

Q.9

The Water and Wastewater Treatment business performance was, understandably, quite muted during the year. What are the prospects in the new financial year?

Despite adverse effect on new order finalisation due to the pandemic, the overall business sentiment in this segment remains positive. There were some vendor supply chain issues and labour problems, while progress on major project sites was also impacted due to movement restrictions. Yet, the segment reported a good performance given the pandemic circumstances. Regular participation in new bids gave us enhanced market visibility during the year, and we expect to secure orders of significant value going forward. The outstanding order book as on March 31, 2021 stood at ₹ 912.02 crore, which includes ₹ 456.87 crore towards Operations and Maintenance contracts for a longer period of time.

Our major achievement for the year was a new landmark overseas EPC order in our Water & Sewerage projects division worth ₹ 156 crore, which was received from Ministry of National Planning, Housing and Infrastructure, Republic of Maldives. We also secured equipment orders worth ₹ 30.50 crore. In addition, we successfully completed a 40 MLD Sewage Treatment Plant (STP) project based on Sequencing Batch Reactors (SBR) technology and another large 210 MLD Intermediate Sewage Pumping Station (ISPS) project for the Bangalore Water Supply & Sewerage Board (BWSSB). We are actively pursuing Public Private Partnership (PPP)/Hybrid Annuity Mode (HAM) opportunities with various Municipal Corporations/Water Boards to catalyse opportunities and to create a unique business niche for our water business. Our experience and learnings from our Mathura project

have been instrumental in giving us the necessary experience, confidence and exposure to such projects.

We hope to secure new business opportunities in the second half of FY 22 after the new COVID pandemic surge eases, and as a result of the positive outcomes of the tenders pending finalisation.

Q.10

What are your expectations from FY 22? Any specific projects or plans that you would like to share with our stakeholders?

Despite the uncertain environment at the start of the year, we are optimistic about the Company's prospects in FY 22. We feel that our learnings of the previous fiscal, coupled with our strong credentials, our considerable expertise and experience, and efficient management of resources will steer positive growth as the restrictions ease and the situation improves from the second quarter of the year. Equipped with a strong digital and technological edge, we are looking at enhanced innovation to leverage the opportunities across business segments.

In the Sugar business, we are exploring digital and Artificial Intelligence (AI) applications to augment sugarcane production management through more targeted initiatives on crop and soil health protection, predictive analytics etc. This, we believe, will further enhance the Company's competitive advantage. With increased capacities and enhanced capacity utilisation driving our response to the Government initiatives to promote distilleries, we see significant potential for growth in our Alcohol business, where our new revenue streams will further complement our strength.



The outstanding order book as on March 31, 2021 stood at ₹ 912.02 crore, which includes ₹ 456.87 crore towards Operations and Maintenance contracts for a longer period of time.

As far as the Power Transmission business is concerned, we are actively exploring additional business opportunities from our existing and new customers, leveraging our extensive product portfolio and geographical presence. We are also exploring opportunities through expansion into new product lines and regions. Renewed industrial growth continues to offer emerging opportunities. For example, we expect to see new opportunities for power generation from Waste to Electricity from various states like Kerala, Punjab and Telangana. Waste heat recovery plants are also becoming popular in the Cement and Steel sectors, offering a great potential for increased business in these segments.

In the Defence and Water businesses, too, as mentioned earlier, we see a lot of promise for growth and expansion, going forward. Overall, we expect order booking across the Power Transmission business segments to improve as the COVID second wave subsides and economic activity improves.

MANAGEMENT DISCUSSION & ANALYSIS



SUGAR BUSINESS

MARKET OVERVIEW

Sugar industry is one of the largest agro-based industries in India, with a total turnover of over ₹1,00,000 crore including sugar and its co-products. It contributes significantly to the nation's socio-economic development. Around 50 million farmers, along with around 2.5 million farm and industrial workers are involved in sugarcane farming and the sugar manufacturing value chain.

Over the past few years, Indian sugar industry has witnessed a structural shift from a cyclical industry into more secular and consistent performance-based industry. The country, over the past few years, has witnessed consistent production much above the consumption levels, which led to a surplus scenario. This was primarily due to improved yields of sugarcane by ~25% coupled with improved recoveries of ~1.5% and the key factor that led to this improvement was change in varietal mix in the largest sugar producing state of Uttar Pradesh (UP). This surplus scenario resulted in India becoming a regular exporter of sugar in the range of 5-6 million tonnes per annum for the past two years and estimated to export 7 million tonnes in SS 2020-21. Another important factor which facilitated the structural shift is a consistent Government policy with regard to sugar and sugarcane

pricing, ethanol blending programme as well as a robust export programme.

The change in varietal balance achieved across the state of UP has been phenomenal with the area under sugarcane for early and high sugar varieties going up to 90% in SS 2019-20 in comparison to an insignificant share of ~11% a decade ago. This has resulted in the state becoming the highest sugarcane and sugar producing state.

Graph showing the sugar production between UP & Maharashtra & All India trend of which amply highlights the share of UP in the all India production over the course of last eight years.

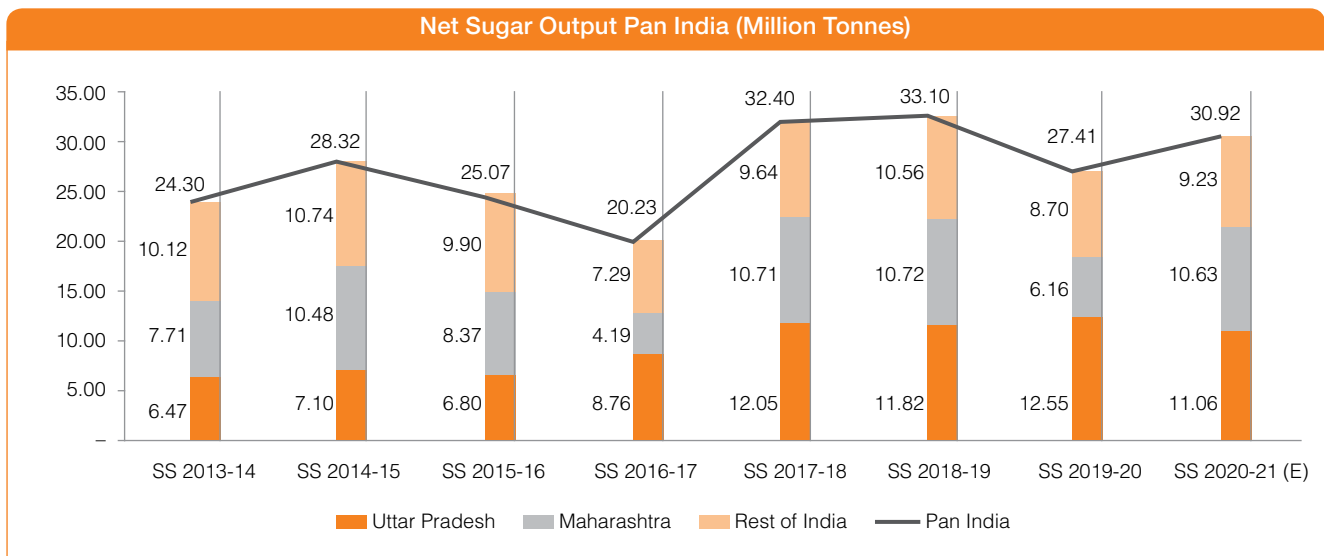

This surplus scenario resulted in India becoming a regular exporter of sugar in the range of 5-6 million tonnes per annum for the past two years and estimated to export 7 million tonnes in SS 2020-21.



India has gained a significant role in the global sugar production, being the second largest producer of sugar while it holds the first position in terms of consumption globally. Over the past four years, on account of the surplus sugar production in the country, India is also gaining its presence in the global trade.

The sugar mills in India have transformed significantly in the past decade by producing sugar, bio-electricity, bio-ethanol, bio-manure and chemicals which contribute ~1.1% to the national GDP. Currently, the sugarcane and sugar related economic activities led to an annual turnover of over ₹ 1,00,000 crore.

For SS 2020-21, the sugar production in the country is expected to increase by ~13% y-o-y to 30.9 million tonnes after considering sugar diversion of about 2.14 million tonnes towards ethanol production during the year as against 27.4 million tonnes in the previous season. The annual sugar consumption of the country is around 26 million tonnes which is the highest globally. India is among the largest producers of sugar globally and it can now be categorised as a structural surplus sugar producing nation as well.

The sugar industry is one of the key strategic focus areas of the Central Government on account of its large stakeholder base as well as its role as a significant facilitator in implementing the clean energy programme for the Government. The various proactive measures by the Government have been instrumental in maintaining the sustainable performance of the industry in the recent years.

Indian Sugar Industry during COVID-19

The global economy has been impacted by the COVID-19 pandemic. The sugar industry in India has largely been safeguarded from this impact mainly on account of the Central and State Government's proactive measures since the industry manufactures "essential goods". The sugar industry operated without any interruption although it faced logistics challenges but these were overcome due to the active support of both the State and Central Government.

Sugar production continued even during the lockdown period of March 2020 till May 2020. Though the overall sugar off-take was lower during the April 2020 and initial days of May 2020, it later picked up due to rise in institutional demand as the manufacturing activities opened up and consumer demand rose. The sugar exports were impacted for a brief period and significant quantity was stuck at the ports but by the end of the first quarter of the financial year, exports also resumed at full momentum.

Domestic Sugar Balance Sheet

For SS 2020-21, the sugar production is estimated to be around 30.92 million tonnes with a likely diversion of over 2.14 million tonnes for ethanol production. In the previous season of SS 2019-20, the sugar production stood at ~27.41 million tonnes and 0.8 million tonnes was diverted for ethanol production.

Sugar production estimates for UP are about 11.06 million tonnes in SS 2020-21 as against 12.55 million tonnes produced in SS 2019-20. The lower estimates in sugar production in UP are reportedly on account of lower sugarcane yields and lower sugar recoveries due to climatic factors and higher diversion to gur/khandsari units as well as through B-heavy molasses for ethanol production. Further, during the current season, it is estimated that approx. 0.73 million tonnes of sugar will be diverted for production of ethanol using B-heavy molasses and sugarcane juice, which is an increase of 78% over the previous season.

Maharashtra has produced about 70% more sugar than the previous season at 10.63 million tonnes while Karnataka has produced 4.17 million tonnes of sugar as compared to 3.38 million tonnes last season.

India started its SS 2020-21 (October to September) with an opening inventory of 10.7 million tonnes as on October 1, 2020. As on 30th June, the actual production of sugar stood at 30.66 million tonnes. Only 5 sugar mills were still operational in the country. With the opening stock of 10.7 million tonnes, the total sugar availability in the country for SS 2020-21 is estimated at 41.6 million tonnes. The sugar consumption is estimated at 26 million tonnes and with expected exports of around 7 million tonnes, thus the total offtake during the season is estimated to be around 33 million tonnes which will lead to the estimated closing inventory of sugar at 8.6 million tonnes on September 30, 2021.

For SS 2020-21, the sugar production is estimated to be around 30.92 million tonnes with a likely diversion of over 2.14 million tonnes for ethanol production.



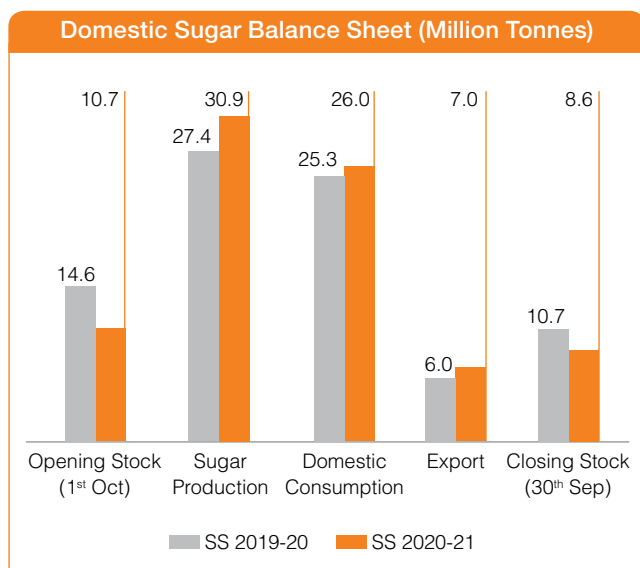

Source: ISMA

Note: Data for SS 2020-21 is estimated

Domestic Sugar Balance Sheet (Million Tonnes)

	SS 2019-20	SS 2020-21
Opening Stock (1 st October)	14.6	10.7
Sugar Production	27.4	30.9
Domestic Consumption	25.3	26.0
Exports	6.0	7.0
Closing Stock (30 th September)	10.7	8.6

Global Sugar Balance Sheet

The world sugar market is extremely volatile and is affected by the sugar policies of the key sugar producing countries notably Brazil, Thailand and India. The demand-supply dynamics in the global market is impacted by the production

in these three key countries and thus affect the global sugar prices and the trading price levels.

As per recent global reports (International Sugar Organisation (ISO)), the global deficit forecast has been lowered for 2020-21 from 4.8 million tonnes earlier to 3.1 million tonnes. The World output is also expected to fall by 1.92 million tonnes in the current year. Due to the pandemic, the consumption should also reduce to 172.4 million tonnes down from 173.8 million tonnes previously forecasted but still up 1.2% year-on-year.

As per reports, the major sugarcane producing region in Brazil, Centre-South Brazil, completed the 2020-21 (April/March) harvest with 605.46 million tonnes of sugarcane crushing which is an increase of 2.6% over the 590.36 million tonnes crushed in 2019-20 as per the industry data. The Centre-South (CS) region of Brazil processed 46.07% of total raw material into sugar during the 2020-2021 harvest producing 38.46 million tonnes of the sugar, representing a 43.73% increase over 26.76 million tonnes in the previous cycle.

As on Jun 29, 2021, reports indicated that sugar production estimates for Brazil's CS region's 2021-22 were revised downwards to 34.1 million tonnes from an April projection of 35.6 million tonnes, as persistent dry weather hurt cane development, food trader and supply chain services. It was also reported that Brazilian millers will be able to crush only 535 million tonnes of sugarcane this season, down from earlier estimates of 558 million tonnes. The update estimates for sugarcane crush are the lowest since 2012.

In Thailand, according to industry reports, the sugarcane crop in Thailand in 2020-21 suffered from unfavourable weather conditions again leading to decline in sugar production to 7.6 million tonnes as against 8.27 million tonnes in 2019-20. Higher local cane prices and forecasts of ample rains suggest a production recovery in Thailand for 2021-22 to be about 10.5 million tonnes, up 38% year-on-year.

Global Sugar Balance Sheet (Million Tonnes)

	SS 2019-20	SS 2020-21	Change in Million Tonnes	Change in %
Production	171.16	169.24	(1.92)	(1.1)
Consumption	170.27	172.38	2.11	1.2
Surplus/Deficit	0.89	(3.14)		
Import Demand	66.50	61.70	(4.80)	(7.2)
Export Availability	66.55	61.96	(4.59)	(6.9)
End Stocks	97.61	94.22	(3.39)	(3.5)
Stocks/Consumption Ratio (%)	57.33	54.66		

Government Policies

In order to support the dynamics of the sugar market and ensure timely payments to the farmers, the Central Government announced various measures during the current season:

1. An export quota of 6.0 million tonnes was allocated to all sugar mills on December 31, 2020 with export date till September 30, 2021 and notified scheme for providing assistance to the sugar mills for expense on marketing costs including handling, upgrading and other processing costs and costs of international and internal transport and freight charges on export of sugar. The aggregate assistance under this scheme was prescribed at ₹ 6,000 per tonne of exports to be used to clear cane payment dues of farmers.
2. Fixed Remunerative Price (FRP) of sugarcane for SS 2020-21 was increased by ₹ 10/quintal to ₹ 285/quintal calculated at 10% recovery with a premium of ₹ 2.85 per quintal for every 0.1% rise in recovery.
3. Minimum Selling Price (MSP) fixed by the Government in Feb 2020 at ₹ 31/kg remained unchanged.
4. The Government of UP kept the sugarcane prices at the same level as last year for the current SS 2020-21. The State Advised Price (SAP) remained at ₹ 315 per quintal for the common variety, while the prices for early variety and rejected varieties of sugarcane remained at ₹ 325 and ₹ 310 per quintal, respectively.
5. The release quota mechanism set up by the Government in the last season is also continued during the current season so as to regulate the supply of sugar into the market, thereby enabling steady sugar prices in the market.
6. Later on May 20, 2021, the Government announced a reduction in its assistance to the export of sugar from ₹ 6,000 per tonne to ₹ 4,000 per tonne of sugar against MAEQ for SS 2020-21 owing to global market dynamics. The reduced assistance is be applicable for the quantity of Maximum Admissible Export Quantity (MAEQ) for which the export contracts/agreements are signed on or after May 20, 2021

Sugarcane Prices

The Central Government announced Fair & Remunerative Price (FRP) for sugarcane and for SS 2020-21 was increased

by ₹ 100 per tonne at ₹ 2,850 per tonne as per guidelines of Commission for Agricultural Costs and Prices (CACFP).

The Government of UP kept the sugarcane prices at the same level as last year for the current SS 2020-21, the State Advised Price (SAP) remained at ₹ 315 per quintal for the common variety, while the prices for early variety and rejected varieties of sugarcane remained at ₹ 325 and ₹ 310 per quintal, respectively.

Sugarcane pricing plays a significant factor in the competitiveness of Indian industry. In view of high sugarcane cost and the resultant higher cost of production of sugar, it is not possible to compete with the export prices without any support from the Government. Sugarcane price in India is 70-80% higher than that of Brazil or Thailand. For self-sufficiency, sugarcane pricing policies would need rationalisation and these need to be brought in tune with global practices. In the state of UP, sugarcane arrears as on May 31, 2021 stood at ₹ 11,803 crore. The Maharashtra sugarcane arrears based on FRP excluding Harvest & Transport (H&T) stood at ₹ 957 crore as on June 15, 2021.

The mismatch between sugar prices and cane prices adversely affects the liquidity of mills and their ability to pay the sugarcane price to sugarcane farmers. The sugarcane farmers and sugar mills are hopeful of an early announcement by the Government regarding increase in MSP of sugar as a measure to improve revenue realisation by mills and payment to farmers, which will in turn ease the current situation of very high sugarcane price arrears.

Sugar Exports

On the export front, Indian millers had achieved export programme for SS 2019-20 and the country exported 6 million tonnes, even though exports were impacted due to lockdown and other logistics problems. Similarly, sugar industry has responded well to SS 2020-21 export programme, even though it was announced late in Dec 2020 after the commencement of the SS 2020-21. Strong international prices helped Indian sugar industry to contract significant quantity of sugar in a short span of time. Market reports are encouraging and indicate that, as on June 15, 2021, contracts of ~5.8 million tonnes have already been made so far out of 6 million tonnes for the current season prescribed by the Central Government. It is also estimated that physical exports of almost 4.4 – 4.5 million tonnes of sugar have been completed during January 2021 to May 2021. In view of strong international prices,

sugar may be exported even beyond export quota of 6 million tonne under Open General Licence (OGL) without availing any export assistance from the Government to maintain liquidity of funds and to generate adequate funds to be able to pay the full cane price to sugarcane farmers. It is possible that export quota may even be surpassed by up to one million tonne, including spill over from the previous season export quota. Expected substantial exports will help in correcting the surplus sugar inventories.

Sugar Prices

Domestic

The average sugar prices for the industry remained range bound during SS 2020-21 with a peak reaching ₹ 3,300 per quintal from a bottom of ₹ 3,100 per quintal. This is mainly on account of the size of the release quota allocated to the domestic mills and brief impact of the lockdown. The carryover stocks of previous season combined with the stocks of SS 2020-21 led to higher inventory in North Indian states. This led to a variation in the domestic price realisation.

Further, the opening stock of 10.7 million tonnes at the start of the season, which is sufficient for more than 5 months' consumption as against the ideal stock equivalent of 2-2.5 months' consumption, also impacted the prices during the crushing season. Additionally, expected substantial increase in sugar production in the state, led many sugar mills from Maharashtra to sell in those markets that are traditionally catered by UP sugar mills. These sporadic sales were to alleviate the problem of storage of sugar and to improve their working capital, thereby putting pressure on the overall market prices.

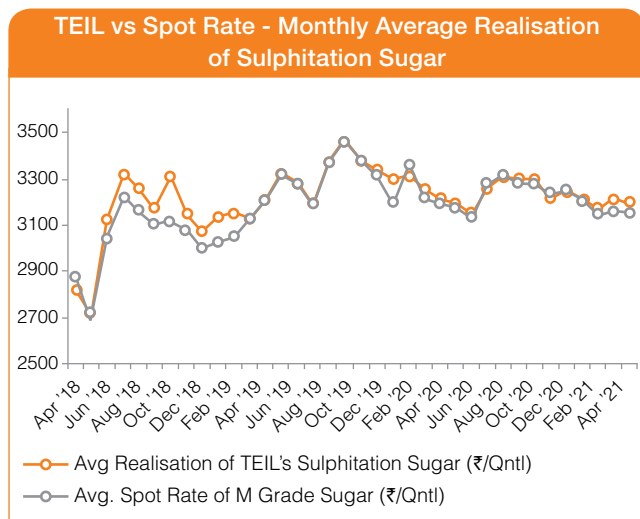

Global

In the last financial year, the global sugar prices remained at lower levels during the beginning of the year from April to May 2020 due to lockdown impacting the overall demand in various parts of the world. The prices started moving upwards from Sep 2020 with rising demand owing to ending of the lockdowns.

The lower production estimates from Thailand and higher diversion of sugar towards ethanol in India led to further firming of prices from September to December 2020. The prices further increased from January 2021 to February 2021 due to reports of dry conditions in Brazil and increasing energy prices and remained range bound since March 2021.

In view of estimated significantly lower production in Brazil in 2021-22, the supply may continue to be tight until Jan 2022 when supply of Thai sugar of 2021-22, which is expected to bounce back to over 10 million tonnes, starts entering the market. Until then, firm international sugar prices may be maintained. It may provide a window for the Indian sugar to export at remunerative prices.

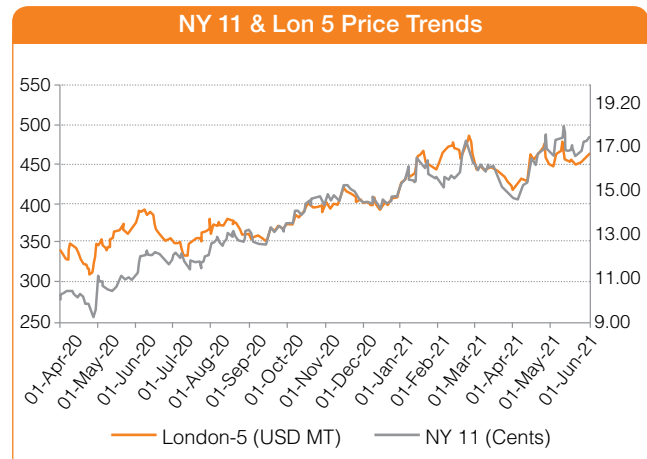

The average sugar prices for the industry remained range bound during FY 21 with a peak reaching ₹ 3,300 per quintal from a bottom of ₹ 3,100 per quintal.



Sugar Business Performance

Triveni operates seven sugar units spread across the state of UP. Most of the mills are located in Western and Central UP, while one unit is located in Eastern UP. The Company manufactures refined sugar, which constitutes over 40% of the total sugar production and realises a premium over normal crystal sugar realisation. The refined sugar is supplied to high grade end-users, thereby creating a niche customer profile for Triveni. The Company also produces different grades of pharmaceutical sugar that can be customised as per the user requirements and over the past few years, has developed a large customer base for this product also.

The seven sugar units strictly adhere to best-in-class manufacturing processes and quality benchmarks. The Company supplies sugar to major multinational soft drink companies, leading confectionery manufacturers, breweries, pharmaceutical companies, dairies and leading ice cream producers.

The Sugar business has performed well in FY 21, owing to continuous improvement in reducing the cost of production of sugar, backed by stability in sugar prices. In terms of sugar production in SS 2020-21, the Company has been ranked second in the country with sugarcane crush of 8.54 million tonnes and sugar production of 0.94 million tonne. Khatauli Sugar Mill achieved the highest sugar production in the country as a single unit and second highest sugarcane crush in the country. Two sugar units recorded their highest ever

crush – Sabitgarh & Rani Nangal. Triveni's focussed sugarcane development programme, with almost 100% high yielding and high sugared variety sugarcane, helped the farmers achieve higher return as a result of high farm productivity while improving the Company's profitability through higher volume of sugarcane crush and improved recoveries of sugar. The production of over 40% refined sugar, coupled with the high-grade pharmaceutical quality sugar produced by the Company, helps it secure higher realisation. The pharma sugar production, which fetches a substantial premium over refined sugar, has also increased during the current sugar season. Such mix of co-product capacities further helps the Company optimise its overall profitability.

Over and above these factors, the strong financials of the Company and its ability to procure funds at a reasonable cost also contribute in achieving consistent profitability. Consequent to surplus sugar production in the country for several years, one of the biggest challenges for the sugar industry has been to effectively manage its working capital, which has increased significantly due to higher production and limited despatches through monthly quota. The Company has managed sugar inventories well through aggressively engaging in exports under the MAEQ scheme as well as through B-heavy molasses for production of ethanol. The total sugar quota for exports under SS 2020-21 MAEQ scheme is 1.82 lakh tonnes and the entire quota was contracted, of which 1.03 lakh tonnes have been physically despatched in FY 21.

Across UP, there has been a decrease in sugarcane yields and sugar recovery largely attributable to climatic factors as well as due to infestation of crop with disease in certain regions. This resulted in a significantly lower sugarcane availability particularly in eastern UP. Further, the sugarcane crush has reduced due to increased diversion (last year the diversion had been lower due to frequent rainfall & COVID-19 pandemic). The sugar production in the state of UP is around 11.06 million tonnes as on June 30, 2021 down from 12.55 million tonnes last year.

Five sugar units operated with B-heavy molasses diversion in SS 2020-21 (one sugar unit operated for part of the season) as against three units in SS 2019-20. This was done to ensure adequate feedstock (molasses) availability for its distillery units. Consequently, the amount of sugar diversion for the ethanol production has increased this season to 75,148 tonnes as compared to 37,004 tonnes in the previous season. Recovery

of 10.98% (Gross Recovery of 11.86% after adjustment on account of B-heavy molasses) recorded in SS 2020-21.

The Company crushed marginally 2.3% lower sugarcane at 8.54 million tonnes as compared to 8.74 million tonnes in the previous season. The decline is mainly due to general trend of lower yields in the state as well as extensive crop damage in Eastern UP due to heavy waterlogging resulting infestation of the crop with disease.

It is important to highlight that though the Company's sugarcane crush and sugar production during SS 2020-21 is lower than the previous sugar year, it has fared better than the state averages where the decline in crush and sugar production is much higher. For SS 2020-21, the Company's crush declined by 2.3% as compared to 8.2% decline for the state on an average. The Company's sugar production declined by 7.0% as compared to 13.0% decline for the state on an average.

(Million Tonnes)

Units	Sugar Recovery (%)		Sugarcane Crushed		Sugar Production	
	SS 2020-21	SS 2019-20	SS 2020-21	SS 2019-20	SS 2020-21	SS 2019-20
Khatauli	11.28	11.67	2.37	2.47	0.27	0.29
Deoband	10.47	10.95	1.60	1.68	0.17	0.18
Ramkola	11.17	12.00	0.64	0.83	0.07	0.10
Sabitgarh	11.50	12.11	1.13	0.97	0.13	0.12
Chandanpur	10.84	12.25	0.99	0.95	0.11	0.12
Rani Nangal	10.97	11.22	1.04	1.03	0.11	0.12
Milak Narayanpur	10.43	10.83	0.77	0.81	0.08	0.09
Group	10.98	11.54	8.54	8.74	0.94	1.01

The average domestic sugar price realisation for the Company was ₹ 32,703/tonne during the year as against ₹ 33,184/tonne in the previous year. Exports realisation price (excluding subsidy) stood at ₹ 24,381/tonne in FY 21 as against ₹ 19,716/tonne in FY 20.

The average domestic sugar price realisation for the Company was ₹ 32,703/tonne during the year as against ₹ 33,184/tonne in the previous year. Exports realisation price (excluding subsidy) stood at ₹ 24,381/tonne in FY 21 as against ₹ 19,716/tonne in FY 20.

Sugar Business comprises three grid-connected large capacity co-generation plants and three smaller co-generation capacities (incidental co-generation facilities) at its five sugar units, namely Khatauli, Deoband, Chandanpur, Milak Narayanpur and Sabitgarh units. Triveni's co-generation plants at Khatauli and Deoband utilise highly efficient 87 ata / 515°C steam cycle to maximise efficient usage of bagasse. After meeting the sugar factory's captive requirement, as well as the co-generation plant's auxiliary power requirement, surplus power from these plants is exported to the grid. The Company has power purchase agreements with Uttar Pradesh Power Corporation Ltd. (UPPCL) for all its co-generation facilities.

Unit-wise capacities of the co-generation plants are as follows:

S.No.	Name of Unit	Capacity (MW)
1	Deoband	22.0
2	Khatauli - Phase 1 & Phase 2*	46.0
3	Sabitgarh	13.5
4	Chandanpur	10.0
5	Milak Narayanpur	13.0
Total		104.5

*Note: Khatauli - Phase 1 & Phase 2 are 23 MW each

Co-generation operations (including incidental co-generation) exported 2,239 lakh units to the grid during the current year as against 1,831 lakh units in the previous year. Consequently, external sales increased to ₹ 68.35 crore in the current year from ₹ 54.16 crore in the previous year, a growth of 26%.

Organic Growth through Triveni Sugarcane Development Programme

Triveni's sugarcane development programme is a key propeller of its socially and financially inclusive growth strategy. The Company continuously engages with the farmers to increase sugarcane productivity through its well-structured cane development programme. The dedicated team of sugarcane development staff works closely with the farmers, disseminating knowledge on the new technologies and innovations in the field of agriculture in general and sugarcane in particular.

The Company has been working relentlessly on varietal development, yield improvement and crop protection. The structured varietal development programme has been instrumental in faster multiplication and commercial exploitation of high sugar varieties e.g. Co-0238 & Co-98014 and hence provide an edge over the peers.

Particulars	2014-15	2015-16	2016-17	2017-18	2018-19	2019-20	2020-21
Area under sugarcane (Ha)	167068	156671	166675	183423	194159	191840	195057
Sugarcane crushed (LQ)	512.72	452.07	640.03	836.70	797.58	874.25	853.97
Sugar produced (LQ)	49.1	48.8	70.8	95.2	94.0	100.9	93.8
Sugar Production (LQ) including sugar loss in B-heavy molasses	49.1	48.8	70.8	95.2	94.0	104.6	101.3
Recovery (%)	9.57	10.80	11.06	11.38	11.79	11.54	10.98
Recovery (%) – considering sugar loss in B-heavy molasses	9.57	10.80	11.06	11.38	11.79	11.97	11.86



The programme has helped in increasing productivity and farmers' income while simultaneously elevating standard of living and social and educational status of 3 lakh plus farmers. The programme is also aimed at helping the Government in achieving the goal of doubling farmers' income by 2022. Triveni's focus during the year remained on the following key activities:

- a. Propagation of high sucrose varieties
- b. Increasing productivity through adoption of new technologies and better farm management practices
- c. Soil health sustenance and improvement through a structured comprehensive programme of soil testing and nutrient recommendations
- d. Better irrigation techniques and water conservation

Cumulatively, these continuous efforts have led to increase in recovery along with significant increase in sugarcane productivity leading to increased sugarcane crushing. With the increasing incidence of red rot reported in Co-0238 throughout Eastern UP and some parts of Central UP, the Company has initiated varietal replacement plan at all its sugar units. Besides focussing on propagation of tested varieties e.g. Co118, Co 98014, CoLk 94184, Co J85 (along with CoJ 88, an improved variety), new varieties e.g. Co 15023 & Co S13235, are being explored. Techniques such as single bud planting are being adopted for faster propagation of the varieties.

The Company is continuously working on yield improvement. Wide row-to-row spacing (specifically, trench technique & paired row technique) besides application of balanced dosage of fertilisers based on soil analysis reports are being propagated aggressively.

Since crop protection (protecting the standing crop from diseases & pests) is integral to the yield improvement endeavours, the Company is working aggressively on this aspect. It has specially incentivised availability of fungicides & pesticides for seed and soil treatment for the sugarcane farmers at all of its units.

The Company also persistently works on dissemination of knowledge on cropping methods for the overall growth of its farmers. They are being educated and persuaded to adopt new scientific and innovative techniques through a well-planned and structured extension programme, involving various digital and conventional tools.

Going forward, the Company believes that the sugar industry should explore potential applications of Artificial Intelligence (AI) in sugarcane production management, crop and soil health monitoring, predictive crop-analysis, while continually improving its existing smart and digital supply chain.

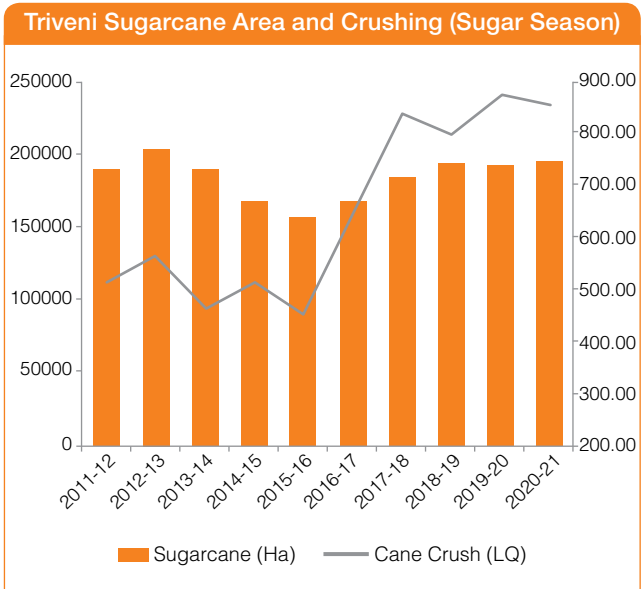

The area under sugarcane for the Company was marginally higher during SS 2020-21 as compared to SS 2019-20. However, the crushing reduced from 8.74 million tonnes in SS 2019-20 to 8.54 million tonnes in SS 2020-21 on account of climatic factors and red rot disease in certain regions.

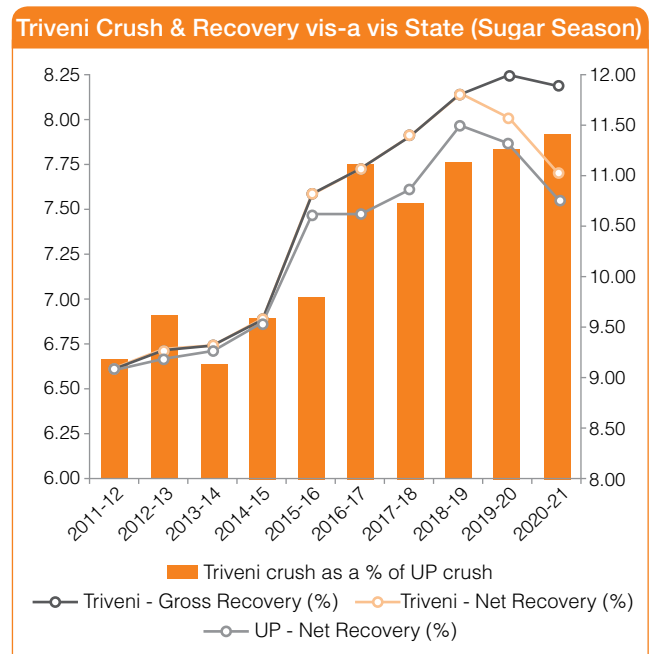

(*) Gross recoveries (after adjustment on account of B-heavy molasses): 11.86% as against 11.97% in the previous period.

The Company has consistently performed better in terms of recovery as compared to average UP state recovery.

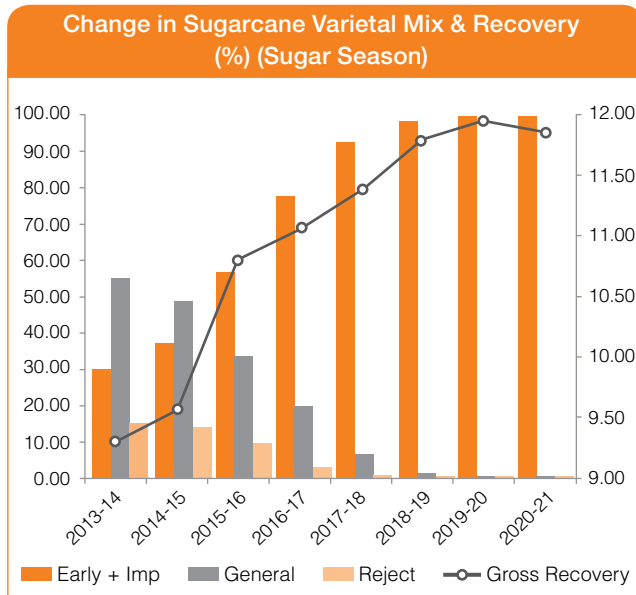

Note: Net recoveries (after adjustment on account of B-heavy molasses): 10.98% as against 11.54% in the previous period.

The Company has achieved around 100% area under early and improved variety of sugarcane in SS 2020-21.

Market Outlook

The sugarcane area in states like Maharashtra & Karnataka has increased as well as crop yield in SS 2020-21. The SS 2020-21 is likely to close with a stock of less than 9.0 million tonnes which is sufficient to cater to the domestic consumption for more than 4 months. The growing diversion of sugarcane juice, B-heavy molasses and C molasses towards ethanol production is positive for the demand-supply in the market which should maintain the prices range-bound.

Initial estimates of SS 2021-22 indicate a production of around 31.09 million tonnes considering rise in sugar production in Maharashtra & Karnataka, as well as increased diversion of sugar to B-heavy molasses / sugarcane juice by around 3.4 million. Water levels in these states are at comfortable levels and it is predicted that the monsoon is expected to be normal.

The sugar supply is expected to be higher than the demand in the domestic market in SS 2021-22. It is imperative that the Government continues to pursue its policy on sugar exports and sugar mills need to aggressively push the ethanol production. India has one of the highest cane prices globally and accordingly, Indian sugar cannot compete effectively in the international market based on its resultant cost structure. Since the Government may not be able to offer export subsidies beyond 2023 due to WTO issues, there is an urgent need to address high cane prices and bring in necessary reforms by way of fixing cane price through Revenue



Sharing Formula (RSF) and Price Stabilisation Fund (PSF). Accordingly, cane price should be fixed as a percentage of sugar revenues and the shortfall, if any, to be contributed by PSF, wherein funds would be contributed when the sugar prices are robust and are more than adequate to pay the cane price. Staggered payment of sugarcane price and increased focus on ethanol blending programme will go a long way to help the sugar sector and make it self-sufficient to operate on market forces with far less regulations and dependence on the Government. The Ethanol Blending Programme is the step in the right direction.

In the medium term, it is estimated that the prospects for the SS 2021-22 may be more balanced in the international market with a surplus of 1.7 million tonnes. Forecasts of ample rains and increase in sugarcane prices suggest a production recovery in Thailand during the next season to about 10.5 million tonnes. The consumption in the global market is expected to grow with little effect of the pandemic. If the oil prices continue to rule firm, the mix of sugar towards ethanol in Brazil may further improve, limiting sugar production for global supply. Considering these factors, the global market prices may remain range bound in medium term.

ALCOHOL BUSINESS

Ethanol Market Overview

The Central Government is focussed on reducing the country's dependence on imported crude oil while reducing the environmental impact of the pollution/emissions. In order to achieve this, the Government has been actively promoting the production and blending of fuel ethanol with petrol, and has targeted 20% blending (EBP20) by 2025. EBP20 which was earlier targeted by 2030, was advanced recently, which reaffirms the Government's focus and commitment.

The blending programme brings several benefits, such as, increase in domestic energy production leading to increase in energy security; reduction of oil import bill, thereby saving foreign exchange; to address structural problems in sugar industry and provide remunerative income to farmers; make use of damaged and surplus grains; and address environmental concerns.

Ethanol Demand Drivers

With population growth and increasing urbanisation pushing the need for mobility, India's transportation sector is growing rapidly, causing dependence on oil to also concurrently rise. Considering the burgeoning oil import bill and the growing concern for the environment, there is a need to adopt non-conventional fuels.

Ethanol, being a value-added product from molasses – a co-product in the manufacture of sugar from sugarcane – benefits sugarcane farmers across the country.

The key drivers for the Ethanol Industry are:

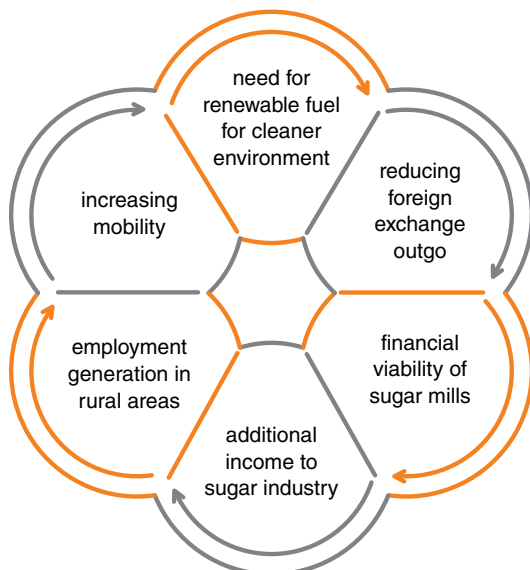

Ethanol Demand-Supply Scenario

For the marketing year 2019-20 (December 2019 to November 2020), the Oil Marketing Companies (OMCs) estimated the requirement at 511 crore litres against which only ~ 195 crore litres were contracted and only 89% of the same was supplied. This resulted in an overall blending of 5% across the country. Around 770 million litres have been produced from B-heavy molasses and sugarcane juice, leading to a reduced production of sugar to the extent of 8,00,000 tonnes.

The ethanol blending programme for the past three years has been as under:

Comparative Supplies (for Marketing Year – Dec - Nov)

Particulars	2017-18	2018-19	2019-20
Supplies	150.50	188.55	173.05
	crore	crore	crore
Blending % age	4.22%	4.92%	5.00%

For the Marketing Year 2020-21, Oil Marketing Companies (OMCs) have issued a tender for 457.6 crore litres against which contracts were finalised for 348 crore litres. Of the total ethanol contracted, 12% quantity is from sugarcane juice and 13% quantity is from damaged foodgrains and surplus rice etc.

The OMCs issued the total Letter of Intent (LOI) quantity of 348 crore litres, during the current marketing year and contracted 326.10 crore litres and 169.4 crore litres of ethanol have been supplied as on June 24, 2021. About 77% of the total supply so far comprises of ethanol made from sugarcane juice/B-heavy molasses. The country, on an average, achieved a blending percentage of 7.79% so far in the current Marketing Year 2020-21, resulting in almost 8-10% blending in most of the states except Rajasthan, Kerala, West Bengal, Assam, NE states, Kashmir and Ladakh.

The Central Government announced the revised prices for ethanol for the season starting from Dec 2020 to Nov 2021: Ethanol from C-heavy molasses - ₹ 45.69/litre (+ ₹ 1.94/litre), Ethanol from B-heavy molasses - ₹ 57.61/litre (+ ₹ 3.34/litre) and Ethanol from sugarcane juice - ₹ 62.65/litre (+ ₹ 3.17/litre).

The Government is targeting to achieve 20% blending of Ethanol by 2025 which would largely solve the problem of excess sugar, relieve sugar industry from the problem of storage of surplus sugar, and also improve the revenue realisation of sugar mills leading to timely payment of

sugarcane dues of sugarcane farmers. EBP 20 is estimated to consume 6 million tonnes of surplus sugar which will lead to stable sugar prices as a result of matching of production with consumption.

Under the WTO norms, the Government cannot provide any assistance for sugar exports from 2023 onwards. In order to manage the demand-supply of sugar in the country after 2023, the Central Government is planning an investment to the tune of ₹ 41,000 crore to achieve the incremental ethanol production capacity.

There is a need of 1,016 crore litres of ethanol in order to achieve 20% blending in the country along with a higher installed capacity of 1,350 crore litres as sugar companies use part of ethanol for producing alcohol by fermenting it with grains, fruits or vegetables.

Government Policies

The various policy initiatives undertaken by the Indian Government for ethanol blending, over the years, include:

2021	Covering Ethanol Blended Petrol (EBP) programme target of 2025 vs 2030 earlier
2020	OMCs have given 5-year off-take programme as against the annual ones in the past
2019	Fixed higher ethanol price derived from different raw materials
2018	National Biofuel Policy
2017	Increase in Ethanol price for MY 2017-18
2016	Introduced mechanism for revision of ethanol price
2015	Fixed pricing mechanism with 10% blending
2013	Price decided through open tenders
2007	EBP with 5% blending mandatory; fixed procurement price
2002	EBP started



Historically, there have been notable interventions by the Government in this area such as the National Biofuel Policy, announced in 2018 for accelerated development and utilisation of biofuels in view of the direct and indirect subsidies to fossil fuels and distortions in energy pricing.

The Policy categorised biofuels as:

- “Basic Biofuels” - First Generation (1G) bioethanol and biodiesel
- “Advanced Biofuels” - Second Generation (2G) ethanol, Municipal Solid Waste (MSW) to drop-in fuels
- Third Generation (3G) Biofuels, Bio-CNG etc.

The Policy expanded the scope of raw material for ethanol production by allowing use of sugarcane juice, sugar containing materials like sugar beet, sweet sorghum, starch containing materials like corn, cassava, as well as damaged foodgrains like wheat, broken rice, rotten potatoes that are unfit for human consumption, for ethanol production.

The recent Government initiatives are given below:

- The Central Government, announced the revised prices for ethanol for the season starting from Dec 2020 to Nov 2021 whereby the ethanol from C molasses will realise ₹ 45.69/litre, an increase of ₹ 1.94/litre and the ethanol from B-heavy molasses will realise ₹ 57.61/litre an increase of ₹ 3.34/litre. The realisation from Sugarcane juice has been revised upward by ₹ 3.17/litre at ₹ 62.65/litre. This augur well for the sugar industry.
- The Central Government also announced a modified scheme for extending financial assistance by way of interest subvention for five years (on the loan availed from banks), @ 6% per annum or 50% of the rate of interest charged by banks whichever is lower, to incentivise enhancement of ethanol distillation capacity or to set up new distilleries for producing 1st Generation (1G) ethanol from feedstocks sugar beet, sweet sorghum, cereals etc. or converting molasses-based distilleries to dual feedstock. It is the step in the right direction to manage with the surplus sugar production in the country and to effectively utilise damaged and surplus grains. This is expected to bring an investment of about ₹ 40,000 crore
- The Government has also fixed remunerative prices of ethanol derived from various feedstocks
- Moreover, OMCs, being the assured buyer for ethanol, had issued tender in October 2020 for ethanol procurement for 2020-21 wherein they have indicated yearly quantity off-

take for the next 5 years. The medium term off-take visibility provided by the OMCs helps the sugar industry to plan its capex programme as there is more clarity in terms of off-take of ethanol over a longer period

- The Government is now targeting to achieve 20% blending of Ethanol by 2025 as against 2030 earlier, which would largely solve the problem of excess sugar, relieve sugar industry from the problem of storage of surplus sugar and also improve the revenue realisation of sugar mills leading to timely payment of sugarcane dues of sugarcane farmers

Our Facilities

The Company's Alcohol business presently comprises two distilleries with aggregate capacity of 320 Kilo Litre per Day (KLPD) – a) 160 KLPD at Muzaffarnagar district is a standalone distillery located between two large capacities sugar units, b) 160 KLPD distillery is located at Sabitgarh, district Bulandshahar, at one of the sugar units.

The Company plans to enhance the total distillation capacity to 660 KLPD before the commencement of the SS 2022-23, with expansion of existing distilleries and two new plants in the pipeline. The first is a new distillery being set up at our Milak Narayanpur sugar mill, which will be operated on molasses/sugarcane juice/syrup & grain. The second is a new grain-based distillery, being set up at Muzaffarnagar.

The existing distilleries are among the largest single stream molasses-based distilleries in India. These distilleries have assured access to consistent supply of captive raw material (molasses) – C as well as B-heavy molasses, sugarcane juice/syrup. In the upcoming distilleries, there would be flexibility to operate with dual feedstock as per the Government of India's Biofuel policy based on economics and availability.

The distillery at Muzaffarnagar has a flexible manufacturing process, allowing it to produce high quality Extra Neutral Alcohol (ENA), Rectified Spirit (RS), Specially Denatured Spirit (SDS) and Ethanol, based on the market dynamics and requirements, whereas the distillery at Sabitgarh is designed to produce only ethanol. The distilleries have been mainly producing ethanol over the last few years for supplying to Oil Marketing Companies (OMCs) for blending in petrol.

In line with the new directives and guidelines of the Government of India regarding effluent treatment and to ensure Zero Liquid Discharge (ZLD), all the distilleries of the Company are based on concentrated spent wash (termed as SLOP) fired incineration. The upcoming distilleries would also follow the same route to treat the effluent with ZLD system.

Sanitizer & Indian Made Indian Liquor (IMIL) plants

The Company had set up a modern hand sanitizer production facility at the existing distillery complex at Muzaffarnagar in the first quarter of FY 21. The objective was to cater to acute shortage of sanitizers to combat the spread of COVID-19. This endeavour of the Company ensured regular availability of the sanitizer from this facility to help fight against the pandemic.

Additionally, the Company has in December 2020 set up a IMIL production facility at its existing distillery complex Muzaffarnagar to capture value in respect of molasses, which are required to be sold to IMIL units at a price much lower than the market price of molasses (reserved molasses). As per the present molasses policy, 18% of C-heavy molasses are required to be sold to the IMIL units. Given the opportunity in the growing market of IMIL in UP, the Company decided to leverage the in-house production facility of ENA into quickly entering into the Indian Made Indian Liquor (IMIL) market. Accordingly, by using molasses in the manufacture of IMIL, the Company would reduce its obligation to supply the reserved molasses.

The Company has received an approval to process ENA up to 52.8 lakh litre for manufacture of IMIL and it has plans

to increase the capacity up to 3.0 lakh cases per month in phases. The products of the Company were launched in the third quarter of FY 21 and have been well received. The Company would be soon launching the Alco-beverages under multiple brands and would target superior market penetration using attractive packaging.

Other Value Add Products from the Distillery By-Products

At distillery unit located at Sabitgarh, the Company has set up a CO₂ Capturing Unit and an Ash Granulation Plant (ash from the incineration boiler is rich in potash content) on Built-Own & Operate (BOO) basis and the same are in operation.

Alcohol Business Performance

Triveni has maintained steady growth in this business, on account of the increasing focus on ethanol production. The proposed increase in capacity would be a further boost to the ethanol business of the Company. A judicious production plan based on B-heavy molasses as well as C-heavy molasses has helped the business to maximise the revenues. In view of ZLD ensured by the Company, higher 350 days operation has been permitted to both the distilleries, which has helped to increase the production.

Despatches

Particulars		FY 21		FY 20	
B-heavy - Ethanol	Lakh Ltrs	565	54%	238	28%
C-heavy - Ethanol	Lakh Ltrs	391	38%	581	69%
Total Ethanol	Lakh Ltrs	956	92%	819	97%
ENA + SDS	Lakh Ltrs	80	8%	27	3%
Total Despatches	Lakh Ltrs	1036		846	
Average Realisation	₹ / Ltr	48.90		46.09	

Production

Particulars		FY 21		FY 20	
Production					
Muzaffarnagar	Lakh Ltrs	543		525	
Sabitgarh	Lakh Ltrs	527		414	
Production (Mzn + Sbt)					
B-heavy - Ethanol	Lakh Ltrs	604	56%	316	34%
C-heavy - Ethanol	Lakh Ltrs	385	36%	577	61%
Total Ethanol	Lakh Ltrs	989	92%	893	95%
ENA + SDS	Lakh Ltrs	81	8%	45	5%
Total Production	Lakh Ltrs	1070		938	



The production and despatches are significantly higher in view of full year impact of the new distillery commissioned in the previous year whereas in the previous year, the operations of the new distillery were stabilised only by Q2 FY 20. During the current financial year, the Company produced 56% Ethanol from B-heavy molasses as compared to 34% last year. The profitability of the distillery in FY 21 is lower due to increased cost of molasses, higher fuel cost, especially during initial stabilisation period of incineration boiler at old distillery at Muzaffarnagar, and non-recurring expenses in relation to discarding of certain fixed assets consequent to installation of new incineration boiler. The distillery received contracts of 10.09 crore litres from OMCs during the ethanol supply year 2020-21.

Market Outlook

Ethanol, also known as fuel alcohol, is blended with petrol as a green fuel. Apart from augmenting the country's fuel self-sufficiency with cost advantage, it helps in reducing the carbon footprint and results in savings of precious foreign exchange on import of crude oil. As per the biofuel policy of the Central Government, ethanol blending was initially targeted at 20% by 2030, creating continued demand from indigenous suppliers. The target has been advanced by

5 years and now the Government is targeting 20% blending by 2025. Continued Government push and incentivisation has helped the industry to set up new facilities and increase the ethanol supplies. The Government has been helping the Industry through remunerative pricing of ethanol derived from various feedstock as well through significant interest subvention on loans availed to fund new capacities. This has helped the industry to significantly enhance the ethanol supplies to OMCs.

Further, loss of sugar in B-heavy molasses and sugarcane juice will also help sugar industry to rectify mismatch between production and consumption of sugar as presently, production being substantially more than the consumption.

The ethanol blending programme will provide alternate revenue stream to the sugar industry, stable earnings, mitigation of cyclicity of sugar sector and improvement in its risk profile.

Despite some glitches like slower lifting of ethanol by the OMCs and lockdown on account of pandemic, the supplies have been steady to OMCs. Going forward, it should help in earning more revenues from the existing distilleries as well as from the upcoming new distilleries.

POWER TRANSMISSION BUSINESS (PTB)

Power Transmission Business (PTB) of Triveni has three distinct segments - Gears, Built-to-Print and Defence Segment.

POWER TRANSMISSION BUSINESS

The Industrial Gears industry

The Gears Industry in India is categorised into Industrial Gears and Auto Gears. The Industrial Gears segment manufactures Gears, Gearboxes, Gear Motors and Gear Assemblies. Industrial gearboxes are a common type of power transmission devices, used as an intermediary equipment in various types of machineries and heavy electrical equipment. The majority of the players in the domestic market manufacture standard products i.e. standardised catalogue type, as it requires less customisation and engineering. There are only a few players in customised gears manufacturing, which requires advanced technology and stringent adherence to international quality and manufacturing standards, with requisite infrastructure and highly skilled manpower.

Demand Drivers

Industrial growth and in turn, industrial capital expenditure in sectors like Power, Steel, Refineries, Cement, Textiles, Sugar

and Mining stimulate the growth for industrial gearboxes market. High speed gears are widely used in turbo applications like steam turbines, gas turbines, compressors, pumps, blowers and test rigs. The aftermarket for above products is strongly linked to plant utilisation levels, cost pressures on maintenance budgets, policy of keeping insurance spares, emergency breakdowns and alternate sourcing other than global OEMs to bring down product life cycle costs.

The increasing deployment of digitalisation and robotics in manufacturing industries including paper, rubber, plastic, chemical, and cement with booming construction industry, especially in developing nations, is facilitating the growth of the industrial gearbox market. The growth in industrial segments require more power generation which in turn is expected to increase the steam turbine market and the industrial gearboxes. A rise in the adoption of combined-cycle natural gas plants as a reliable source of energy is one of the key reasons for the growth of the steam turbine and industrial gearboxes.

Large investments made by private organisations and Governments in material handling, metal and mining, construction, constant investments made in developing automation in India, China, and Japan, are expected to add to the growth in global industrial gearbox market.



The expansion of Oil & Gas downstream infrastructure is expected across the globe due to increasing demand for refined petroleum products. African countries such as Nigeria and Algeria are planning to become regional hubs for refiners and opportunities will arise for new refineries in these markets.

Business Opportunities

As a result of the policies being pursued by the Government of India, business sentiment and capacity utilisation have improved perceptibly and there are some indications of fresh capital investment in industrial segments like steel, cement, sugar and oil and gas. Increased acceptance of engineered capital goods from India in global markets has boosted sourcing from quality-conscious credible Indian manufacturers.

New opportunities for power generation is expected from Waste to Electricity from various states like Kerala, Punjab and Telangana. Besides, Waste Heat Recovery plants are becoming popular from cement and steel sectors.



In addition, there are many Government policies which may benefit the business in short & long term:

- BS-6 policy has given way to Refinery expansions, both brownfield and greenfield, having potential for high speed gearboxes for all applications
- Pollution control equipment are made mandatory for Thermal projects. The new standards are estimated to cut PM emissions from new thermal plants (after 2017) by 25%, sulphur dioxide emissions by 90%, nitrogen oxides by 70% and mercury by 75%. There will be requirement for Gearboxes for FGD – SO₂ reduction and Oxy blower requirements for NO₂ reduction in the next 3-4 years
- New nuclear power plants are under construction under the Department of Atomic Energy where opportunities will come for boiler feed water pump application

Segments – Products and Aftermarket

Products Domestic

This business caters to both High Speed Gears and niche Low Speed Gears segments used as speed increasers and speed reducers. It has a leadership position in High speed gears segment in India and enjoys a market share in the range of 80-90% across all major OEMs supplying Steam Turbines, Pumps and Compressors, FD and ID Fans.

Major customers for high speed gears segment include Indian OEMs of Steam Turbine, Gas Turbine, Centrifugal Pumps and Compressors, FD and ID Fans catering to API and Non-API segments. In the low speed segment, the Company caters to gearboxes used in reciprocating compressors, pumps mainly used in Oil & Gas and Fertiliser plants. The Company also caters to the low head hydropower units which require gearboxes for power generation.

Products Exports

Currently, Gears business is catering to international OEMs successfully in select geographies like Japan, Korea, China, Malaysia, and Indonesia and in Europe (Italy, France, Germany, and Spain), US and Latin America. During the year, the business entered new regions of Brazil and Czech Republic. Most of the global OEMs have relationship with PTB through their Indian operations which is being leveraged.

Products Highlights

- Products segment has seen 9% growth in order booking. Decline in turnover by 15% in the current year is due to COVID-19 related issues and constraints



The growth in industrial segments requires more power generation which in turn is expected to increase the steam turbine market and the industrial gearboxes.

- PTB witnessed contraction in orders from Domestic OEMs by 10% during the year partially due to COVID-19 impact and also due to sudden steel price hike
- Products exports order booking has increased by more than 200% during the year as a result of strategic push given over the past few years
- PTB bagged multiple orders for supply of compressor gears and gearboxes from India and overseas customers which may also be a potentially high growth segment going forward
- Received orders for Flue Gas Desulphurisation (FGD) blower application from domestic OEMs, carrying good future potential
- 6 New OEMs were added in FY 21

Aftermarket Domestic

Aftermarket segment caters to high speed and niche slow speed gears, gearboxes, services of Triveni and other global brands of gearboxes across industry segments including power upgrades, for API & AGMA requirements. Make-in-India initiative of the Government of India has been instrumental in the reduction of capital goods import, particularly from public sector, helping PTB business to push replacement solutions strongly.

Aftermarket Exports

Major focus in Aftermarket Exports was in the Middle East followed by South East Asia and East Africa. PTB intends to build on the existing strategy of spreading network of aligned agents to achieve growth in the export markets, as that remains a strong focus area for the business going forward.

Aftermarket Highlights

In view of numerous uncertainties due to COVID-19, the turnover of the aftermarket segment declined by 10% but

order booking was maintained at last year level, which aggregates to about 40% of overall PTB's business.

Consistent with the strategy of exploring new avenues and segments, PTB has expanded its presence in compressor as well as Power Gen Load gears as both these segments offer promising growth potential from domestic and export markets, and particularly from different operating units of existing large accounts. Ten new high potential customers were added during FY 21.

Refining, IPP, Steel, Petrochemical and Fertilisers were the major contributors for FY 21 order bookings.

In the Aftermarket segment also, the business aligned to the overall strategic push whereby exports grew by 25% during the year and it is expected that the trend may continue in future as well. Customer retention and growth through existing relationships has been consistent as during FY 21 with 95% of bookings coming from existing customers.

BUILT TO PRINT

Power Transmission business has partnered with global OEMs for precision manufacturing of components for wind gearboxes as well as industrial high-speed compressor gears, helping the business to enhance capacity utilisation productively. This segment offers high potential for growth for exports in the medium to long term. In FY 21, Built to print segment has significantly contributed towards higher order booking from the overall exports than the previous year.

The new segment of compressor gears which the Company entered in the last few years, with leading OEMs is expected to show growth in the coming years from domestic and export markets.

DEFENCE BUSINESS

Defence business is poised to cater to engineered equipment requirements for Defence under the Make in India initiative. With the background of having experience in critical rotary machinery technology and experience of supplying and meeting requirements of Defence and Defence support organisations in the past, group's expertise in turbo machinery, Defence business has been able to get approval for both new projects as well as for refurbishing requirements in naval defence space.

In order to promote indigenous design and development of defence equipment, most of the new enquiries in Indian Navy have been issued to promote Indian industry for major mission critical equipment and services. Triveni is actively engaged with the Naval headquarters, Shipyards and other naval establishments to align with the major upcoming projects with indigenous designs in the area of shafting and critical application pumps or with transfer of technology (ToT) collaborations for varying products as stabilisers, power generation sets, etc. In addition, Triveni is also venturing into niche areas like propulsion system integration with a technology partner in a collaborative work share arrangement.

The Government of India's 'Make in India' initiative has led to new opportunities for diverse engineered products and Triveni's Mysuru facility is actively participating in many of these indigenous development projects. The Defence Procurement Policy 2020 focusses on self-reliance for various equipment in Design, Development and Manufacture by Indian Industry. Most of the new projects envisaged by the Defence sector are customised requirement for critical equipment, offering substantial value to the existing portfolio of PTB's rotating machinery. PTB is initially focussing on Naval Defence markets and has gained some foothold in the critical turbo pumps space.

Defence business can significantly contribute on indigenisation of gearboxes to further align with Aatma Nirbhar programme announced by Government of India. Defence business is also currently working on several projects under Make-In-India programme, related to engineered products as well as gearboxes for Indian Navy as well as Indian Coast Guard.

The Defence business is also poised to grow as the Government of India has ambitious plans to spend on the country's defence especially in the naval segments. This will also augur well for Triveni to achieve growth in the medium to long term.

Power Transmission Business Performance

Power Transmission Business achieved a turnover of ₹ 130.08 crore during the year, a decline of 15.6%, and segment profit

of ₹ 40.9 crore, lower by 15.7% than the previous year. The total order booking, however, during the year was marginally higher than last year at ₹ 157.8 crore. The outstanding order book as on March 31, 2021 stood at ₹ 166.23 crore including long duration orders of ₹ 66.63 crore executable over a couple of years.

Impact due to COVID-19

The capital goods (comprising of power generating equipment, material handling equipment, furnaces, mining machinery, etc.) has borne the maximum adverse impact of the COVID-19 pandemic, which in turn has also affected the performance of PTB.

COVID-19 pandemic had posed unprecedented challenges in terms of delays, hold, travel restrictions, closure of plant / partial running, migration of labour across regions and these demanded intrinsic changes in business operations. As a result, the investments as well as existing projects were postponed by customers. PTB was forthright to get prepared in a shorter span of time for conducting negotiations, contractual resolutions and remote monitoring of product testing including online service support. This helped PTB to maximise turnover in the given scenario and aggressive push was given to maximise bookings.

While the domestic steel demand is expected to take some hit due to the ongoing second COVID-19 wave, production of the commodity is also expected to align itself temporarily to meet urgent Oxygen requirement for medical reasons and has returned back to normalcy. As a result, the second wave impact is expected to be significantly lower as compared to first wave.

Market Outlook

Steel, power, cement, telecom, coal and mining were some of the sectors that accounted for the bulk of the capex undertaken by both private as well as government players on the back of friendly GOI policies on infrastructure spending.

Coal-based power added 3.1 GW to total generation capacity in the eleven months to February 2021, taking its total installed capacity to 201 GW. India's power demand is expected to rise to 1,905 TWh by FY 22 from current generation level of 1,558.7 TWh. The growth in infrastructure and real estate sector, post-COVID pandemic, is likely to augment the demand for cement in 2021. The industry is likely to add ~8 MTPA capacity in cement production. The industry could benefit with the pent-up demand phenomena as the economy has been on an unlock mode but on the flipside as the second wave of the contagion is hitting the economy, this could be a detriment to the entire demand-supply of the industry. With the rural markets normalising, the demand outlook remains strong.

The overall fertiliser production grew by 4-6% during FY 21. The country witnessed on-time arrival of Southwest monsoon, followed by a quick spread across the region, which has resulted in higher sowing, thus augmenting the sales of fertilisers, which has led to an increase in production. The Government is reviving 5 closed fertiliser plants which will have potential for gearbox replacement.

Under the new Petroleum, Chemicals and Petrochemicals Investment Region (PCPIR) Policy 2020-35, a combined investment of USD 142 billion is targeted by the year 2025 in all the PCPIRs across the country. PCPIR Gujarat has already attracted investments wherein various Indian and multinational companies have opened facilities. PCPIR Rajasthan is actively working towards brining investments from top global players which will open ample opportunities for new facilities.

India's oil demand is projected to reach 10 million bpd by 2030, from 5.05 million bpd in 2020. The Government allows 100 percent Foreign Direct Investment (FDI) in upstream and private sector refining projects.

National Steel Policy 2017 had envisaged achieving up to 300 MTPA of production capacity by FY 31 from current level of 140 MTPA. The steel production in India in 2020, however, was down by 10%, to 97 MTPA, as against the ideal level of 110-120 MTPA. Indian Japan Steel Dialogue is expected to boost the steel sector on total production and capacity expansion. The increased capital expenditure for infrastructure projects in Union Budget 2021-22 is likely to push up the demand for infrastructure in the country.

Paper industry was one of the most affected (during the pandemic) as educational institutes were shut down. Education is one of the big drivers for the paper industry in India. Paper and Paperboard market in India is expected to grow at CAGR of ~5% cumulatively from 2021-26 due to higher growth of food and beverages, cosmetics, and other industries in India. Paper consumption is forecasted to increase by 7.6% per year in the coming years.

Indian sugar mills' output rose by nearly a fifth year on year to 27.76 million tonnes in the first six months of FY 21. The Indian sugarcane market is projected to reach a CAGR of 4.3% during 2020-25.

On the backdrop of contraction during FY 22, consistent with economic growth expected in the domestic and international markets, PTB expects smart growth not just from domestic market but further consolidation into exports. Combined with the overall demand growth and also strong orders in hand position at the end of FY 21 of ₹ 166.23 crore, PTB expects promising growth during FY 22.

WATER BUSINESS

Market Overview

The urban population in India, which stood at 377 million in 2011, is expected to grow by 404 million to become 781 million by 2050 (World Urbanisation Prospects, 2014). Many Indian cities get their water supply from sources far away at high costs including for energy used for pumping water to these cities. Cities with larger populations generally rely more on surface water than the groundwater. In cities, where groundwater is the source of water supply, aquifers are getting depleted due to over extraction. At the same time, sanitation has not kept pace with water supply in the country. Human health and economic prosperity are very much dependent on clean water supply and good sanitation as on other factors. Hence, it is important to look at how pollution of water sources, especially from sewage, affects water quality and water security.

An integrated approach needs to be evolved, balancing infrastructural and socio-economic measures for water quality management. This approach demands construction of new wastewater treatment systems, improvement of the existing wastewater treatment systems, upgrading of wastewater treatment technologies and renovation of the sewer system, all with sharper focus on economy viability. Importance should also be given to creating awareness on sanitation and pollution issues among users to ensure their cooperation in maintaining their own environment. The "Clean India" or





“Swachh Bharat” campaign will be successful only if water is available in the toilets constructed and if the wastewater generated is also treated and the treated water reused or disposed of in a sustainable manner.

FY 21 has been subdued due to COVID-19 pandemic which affected largely in the finalisation of new orders. On the execution of orders, due to labour migration & COVID-19 related restrictions, the progress in major project sites got impacted adversely. Large numbers of vendors who were supplying equipment to us also suffered due to pandemic and manpower shortage.

The Company is pursuing opportunities with National Mission for Clean Ganga (NMCG), UP Jal Nigam, Delhi Jal Board, Bangalore Water Supply & Sewerage Board, Pali CETP Foundation, Pune Municipal Corporation, other opportunities in Maharashtra and various other Clients in EPC and HAM/PPP projects. The PPP opportunities for STP recycling on PPP format are also being explored.

Market Analysis

The global water and wastewater treatment equipment market size was valued at USD 61.60 billion in 2020 and is expected to grow at a compound annual growth rate (CAGR) of 4.0%

from 2021 to 2028. Addressable market for the Company is ~₹ 5,000 crore annually.

- The wastewater treatment plants market in India is projected to grow at a CAGR of over 12% during 2021-25
- India’s industrial water and wastewater treatment market is expected to reach USD 2.3 billion by 2022
- India’s water and wastewater treatment chemicals market is projected to reach USD 805 million by 2023
- Indian pharmaceutical industry is forecast to grow at a CAGR of 12.89% over 2015-20 to reach USD 55 billion by 2020. This is projected to drive the Indian industrial wastewater treatment plants market
- Due to rising water shortages, the water industry in India has turned into a multibillion-dollar industry.
- Each year, the Government spending on water infrastructure is increasing under various schemes
- State Governments are also hiking investments in setting up more water and wastewater treatment plants
- There is a healthy demand for Water & Wastewater treatment plants in India

- There is a significant increasing demand for water due to population growth, agricultural use, environmental degradation and economic development

Demand Drivers

To meet the increasing demand and maintain the pace of the rapidly growing market, all the OEMs in the water industry are focussing on core technologies and new products suitable for local market as well as increasing global requirements. While on one hand, companies need to be agile and scalable in terms of capacity and capabilities, they also need to cut time and costs when releasing new solutions and products. Most OEMs have started integrating themselves to multi-location (across the globe) offices cum factories and remote design centres from a localised design cum manufacturing base. This helps to reduce the project cycle time and build more capacity.

Water scarcity and strict regulation has led many industries to adopt water-recycling systems especially in the food, textile, pharmaceutical, chemical and power industries. Zero liquid discharge (ZLD) systems and wastewater recycling are becoming increasingly popular in India. We have used this technology in projects like Balotra which is 18 MLD capacity ZLD plant, wherein effluent is recycled back to industries for reuse after treatment.

The municipal wastewater discharge has become a critical problem for environmental and public health concern and the intervention have been placed with the introduction of high tech and innovative wastewater treatment technologies but because of its inefficient, incomplete and expensive approach it is important to adopt integrated approach such as: 1) minimisation and prevention, 2) treatment for reuse, 3) natural self-purification.

Due to revision of discharge standards of STPs in metropolitan & other areas by NGT, which has become more stringent, all older STPs become non-compliant and there is a need for retrofitting & refurbishment of these plants. Going forward, there will be enormous opportunities in this segment.

The Central Government's focus on Namami Gange for cleaning of Ganga, JICA funded projects in Delhi, Karnataka and Maharashtra, AMRUT programmes for Pollution abatement, Recycling and Re-use, Stricter Vigil by National Green Tribunal will be key demand drivers.

Due to COVID-19 disruption, FY 21 was subdued for new orders owing to funding crunch and change of priorities. The next year FY 22 is expected to be much better in terms of new order intake.

Business Opportunities

- **Significant financial support from the Government:** In the past five years, the Government has introduced a number of programmes and schemes to improve the country's water supply and sewerage infrastructure. The JJM, AMRUT, the Namami Gange programme and the Swachh Bharat Mission were launched to help scale up infrastructure capacities. These projects are estimated to entail an investment of over ₹ 3 trillion. Over the past 2-3 years, there have been visible improvements in water supply and waste management at the city level. There have been some improvements in the financial and operational capabilities of Urban Local Bodies (ULBs).
- **Private sector to play a bigger role in infrastructure creation and service delivery:** As the sector's long-term investments cannot be met by public sector expenditure alone, the private sector has an important role to play in the water supply and sewerage sector. Therefore, private sector participation is being encouraged in areas such as providing 24x7 water supply, and setting up sewage treatment plants (STPs), Waste-to-Energy (WtE) plants and recycling and tertiary treatment facilities. In the past few years, a number of projects have been implemented on a public-private partnership (PPP) basis. A new PPP format, the hybrid annuity model (HAM), which is a mix of the engineering, procurement and construction and build-operate-transfer models, is being used for setting up STPs under the Namami Gange programme. ULBs are entering into long-term (15-20 years) operations and maintenance (O&M) contracts for operating and maintaining water and wastewater treatment facilities.
- **Greater attention being paid to capacity building, recycling and reuse, rationalising user charges and Non-Revenue Water (NRW):** Strengthening the capacities of ULBs is one of the top priorities of state governments today. They have been incentivising and encouraging local bodies to become self-sufficient and mobilise resources through instruments such as municipal bonds. Nine cities – Pune, Greater Hyderabad, Bhopal, Amaravati, Ahmedabad, Lucknow, Surat, Vizag and Indore – have issued municipal bonds to fund infrastructure development. As part of the reform process under AMRUT and Smart City Management, a number of ULBs have shifted to computerised accounting systems and e-service delivery platforms. District metered areas are being established to better manage water distribution networks. Pipeline repair/replacement works are being carried out to plug leakages, reduce NRW and replace obsolete pipes.

Water Business Performance

Water business was impacted during the year due to COVID-19 pandemic in terms of disruptions in project execution and delay in order finalisation. Despite such constraints, the Company has recorded annual turnover of ₹ 260.74 crore with a PBIT of ₹ 26.74 crore (on a consolidated basis) in its Water business during the year.

Turnover	Amount in ₹ Crore
Equipment	25.96
Industrial	66.88
Municipal	140.98
O&M/Others	26.92
Total Turnover	260.74

The Operation efficiency has improved during the year which is evident from indirect and administrative cost which remained under control.

Going forward, majority of investments are expected from the Central Government through NMCG and JICA, besides State funding from Karnataka, UP, Delhi, MP, Bihar, Jharkhand, Maharashtra and Rajasthan. WBG is well positioned to undertake more jobs in its chosen area of expertise. WBG has secured one package in Maldives towards the end of the year and actively looking to expand in foreign market; it will continue to evaluate opportunities in neighbouring countries on case-to-case basis.

Key Highlights

1. Secured new Overseas EPC orders of Water & Sewerage projects worth USD 22.80 million (₹ 156 crore, net of GST) from Ministry of National Planning, Housing and Infrastructure, Republic of Maldives, funded by Exim Bank of India

Water business was impacted during the year due to COVID-19 pandemic in terms of disruptions in project execution and delay in order finalisation. Despite such constraints, the Company has recorded annual turnover of ₹ 260.74 crore.

2. Secured Equipment Orders of ₹ 30.50 crore
3. Achieved turnover of ₹ 260.74 crore in FY 21 and PBIT of ₹ 26.74 crore (on consolidated basis)
4. Completed 40 MLD STP based upon SBR technology for BWSSB
5. Completed 210 MLD ISPS project for BWSSB
6. Regular participation in new bids have given a recognition in market

Market Outlook

Rapid urbanisation, combined with declining freshwater resources in the country, is expected to drive the adoption of innovative technologies and improvement of service delivery mechanisms. The private sector needs to play a larger role in driving this trend in innovation. While the Smart City Management is a big leap forward, certain measures need to be taken to ensure that it meets its purpose and targets. Equally important is the need to focus on mobilising new funding sources. ULBs also need to build financial and operational capacity.

The Outlook for FY 22 is positive and the Company sees potential business opportunities of approx. ₹ 4,000 crore through bids in first half of FY 22 including EPC and HAM projects. We expect that COVID-19 pandemic will subside in first half of FY 22 and normal business may start in second half of FY 22.

Hybrid Annuity Model (HAM) opportunities in Water Business

As we all are aware that Water is a State subject and is largely underfunded. There are several projects which are stalled due to lack of funds. The Company is in discussion with several Municipal Corporations / Water Boards to persuade them to implement projects on PPP / HAM basis with a view to generate business opportunities and to create a business niche for ourselves. The Company with its strong financials can invest in PPP / HAM concession projects and increase EPC opportunities. Apart from the State projects, many projects under the NMCG are also adopting the HAM route to finalise projects. The Company has submitted a number of bids under this programme and is also expecting many more opportunities to come in the current financial year. With good experience in the project at Mathura (HAM), the Company is well positioned to approach the market through this route and the learnings from the on-going project will help it to achieve success.

FINANCIAL REVIEW

₹ lakhs

Particulars	FY 21	FY 20	Change %
Income from operations (Gross)	469321	442357	6%
EBITDA	58423	57283	2%
Finance Cost	5144	7932	-35%
Profit Before Exceptional items & Tax	45370	41862	8%
Exceptional income / (expenses)	-2183	282	
Tax	15856	9396	69%
Profit After Tax	27331	32748	-17%
Other Comprehensive income	-29	-96	70%
Total Comprehensive income	27302	32652	-16%

The pandemic had the effect of pulling down business activities due to multiple factors, such as, suspension of business activities due to lockdown, subdued demand, distortion of supply chain, reduced labour availability, financial constraints, productivity issues due to health and social distancing norms, restrictions on travel to meet customers, pandemic-related constraints with customers to proceed with the project or take contractual deliveries. It was fortunate that our Sugar and Distillery operations remained largely insulated, being in the category of essential goods. However, in respect of the engineering business, there were issues relating to order booking / finalisation, supply chain and delays in taking delivery by customers but overall, the loss of business has not been significant.

The Company has reported an increase in turnover by 6% and increase in PBT (Profit before Tax) before exceptional items by 8% in the current year. Sugar business (including Distillery & Cogeneration operations) has posted 10% increase in turnover with 2% increase in Segment Profits (Profit before Interest and Tax – PBIT) while the turnover of the Engineering Business is lower by 15% with reduction in Segment Profits by 4%. The performance of engineering business was impacted by COVID-19 related issues, which resulted in delayed order finalisation, slow progress in few jobs as well as deferment of few jobs / deliveries to the next financial year.

Finance cost during the year is 35% lower than the previous year, despite lower buffer stock subsidies by ₹ 17.93 crore, mainly due to lower utilisation of term loans by 13%, working capital by 56% and lower cost of funds. The lower utilisation of working capital has resulted from better inventory

management and realisation of large amount of subsidies receivable from the Government.

Exceptional items comprise an impairment charge in respect of equity investment in the associate Company, Aqwise Wise Water Technologies Ltd (“Aqwise”). The Company signed a Share Purchase Agreement dated March 25, 2021 for divesting its stake in Aqwise and accordingly, based upon estimated consideration to be received, an impairment loss of ₹ 23.20 crore was recognised.

During the year, tax incidence and effective tax rate were higher than the previous year as in the previous year, deferred tax charge was lower by ₹ 40.60 crore due to remeasurement of deferred tax liability (net) which is expected to reverse in the future when the Company would have shifted to the new tax regime pursuant to Section 115BAA of the Income Tax Act, 1961. In view of high tax incidence, profit after tax is 17% lower at ₹ 273.31 crore. As the Company has exhausted all MAT credit and certain exemptions/deductions, it may be subject to lower tax rates under new tax regime for the subsequent periods.

Raw Material and Manufacturing Expenses

₹ lakhs

Particulars	FY 21	FY 20	Change %
Cost of material consumed	323693	303297	7%
Percentage to sales	69%	69%	
Manufacturing expenses	24892	23465	6%
Percentage to sales	5%	5%	

Raw Material costs have increased by 7% commensurate with increase in sugarcane crush by 8%. Raw material cost for FY 20 is net of production subsidy/export incentive (@ ₹ 13.88/quintal pertaining to cane crush in April/May 2020 forming part of SS 2018-19) of ₹ 24.27 crore. Raw material percentage to sales may not be indicative in sugar business as raw material consumption is directly linked to the sugarcane crush and production of sugar and not sale of sugar.

Manufacturing expenses have increased by 6% mainly due to higher cane crush by 8% and higher production in distillery by 14%. In sugar business as well as in distillery, such costs are directly linked to the production rather than to the sales.

Personnel Cost, Administration Expenses and Selling Expenses

₹ lakhs			
Particulars	FY 21	FY 20	Change %
Personnel cost	27006	25498	6%
Percentage to sales	6%	6%	
Administration	9450	8802	7%
Percentage to sales	2%	2%	
Selling expenses	6455	6136	5%
Percentage to sales	1%	1%	

The increase in personnel cost is due to normal annual salary increase. The increase in Administrative expenses is mainly because of increased activity, including full year operations of the new distillery and certain non-recurring expenses pertaining to discarding of fixed assets of ₹ 3.61 crore necessitated due to installation of an incineration boiler at old distillery at Muzaffarnagar. Selling expenses are higher due to increased sales volumes in distillery as reduced by savings in transportation costs relating to lower sugar exports.

Segment Analysis

Description	Revenue (Gross)			PBIT*		
	FY 21	FY 20	Change %	FY 21	FY 20	Change %
Business Segments						
- Sugar	460687	418857	10%	47555	46804	2%
- Engineering	38068	44709	-15%	5975	6203	-4%
- Others	7144	8071	-11%	-45	-47	4%
Unallocated/inter unit adjustment	-36578	-29280	-25%	-2971	-3166	6%
Total	469321	442357	6%	50514	49794	1%

*Before exceptional items

The Company has two major business segments – Sugar Business and Engineering Business. Sugar business comprises sugar manufacturing operations across 7 Sugar mills, 3 Cogeneration plants located at two of its Sugar mills, 03 Incidental cogeneration facilities at three of its sugar mills and two Distillery units, all located in the State of U.P. Cogeneration

plants and Distillery units source captive raw materials, namely, bagasse and molasses respectively, from the sugar mills. Engineering business comprises Power Transmission business having manufacturing facilities at Mysuru, and Water and Wastewater Treatment business operating from Noida, UP.

Sugar Business Segments

Sugar Operations

₹ lakhs

Description	FY 21	FY 20	Change %
Turnover	399476	374324	7%
Power exported to UPPCL	6835	5416	26%
PBIT (Segment Profit)	37450	35749	5%
<i>PBIT/Turnover (%)</i>	9%	9%	
Cane crush (MT)	9049439	8393100	8%
Recovery % Gross	11.80%	11.93%	(13 basis points)
Recovery % (net of sugar loss in BHM*)	11.12%	11.57%	(45 basis points)
Production of sugar (MT)	1007299	970731	4%
Volume of sugar sold (MT)			
Domestic	879568	795096	11%
Export	223665	274449	-19%
Total	1103233	1069545	3%
Average sugar realisation price (₹ / MT)			
Domestic	32703	33184	-1%
Export (Ex-mill price excluding subsidies)	24381	19716	24%
Average	31016	29728	4%

(*) B-heavy molasses

There was a general trend of lower yields and recovery in the SS 2020-21 in Uttar Pradesh but the Company has fared much better and the decline in crush and recovery in the SS 2020-21 is much lower than the decline in the average of the state of Uttar Pradesh.

Segment profit during the year has increased by 5% despite the fact that previous year was benefited by higher export subsidy of ₹ 35.57 crore pertaining to FY 19. The increase in the segment profit is attributed to higher sugar despatches and improved margins, particularly in exports. In respect of exports made during the year, subsidies of ₹ 57 crore (Previous year - ₹ 57.66 crore) could not be booked pending fulfilment of the prescribed conditions and the same will be recognised subsequently on completion/fulfilment of relevant conditions.

During the year, the cogeneration operations have been merged with the sugar operations and the cogeneration activities no longer qualify as a separate operating segment. Accordingly, these have been combined with the sugar segment in accordance with Ind AS 108 'Operating Segments' and the figures of the previous year / periods have been regrouped.

Distillery Operations

₹ lakhs

Particulars	FY 21	FY 20	Change %
Gross Turnover	54376	39117	39%
PBIT	10105	11055	-9%
<i>PBIT/Turnover (%)</i>	19%	28%	
Operating days	329	307	7%
Production (KL)	107027	93826	14%
% Production from BH Molasses	56%	34%	
Total Sales Volume (KL)	103637	84566	23%
% Ethanol to total sales volume	92%	97%	
% Ethanol sales produced from B-heavy molasses	55%	28%	
Avg. realisation price of alcohol ₹ / litre	48.90	46.09	6%

The turnover in Distillery operations is substantially higher than the previous year on account of full year impact of the new distillery which was set up in the previous year at Sabitgarh and also due to higher operational days due to installation of incineration boiler at Muzaffarnagar. Consequently, the production has increased by 14% during the year and sales volume by 23%. Segment profits are, however, lower by 9% due to increased cost of molasses and due to certain non-recurring expenses relating to discarding of fixed assets upon installation of incineration boiler at the old distillery at Muzaffarnagar.

Currently, the distillation capacity is 320 KLPD, and the Company is proposing to set up a dual feed 160 KLPD distillery at our sugar unit at Milak Narayanpur and another 40 KLPD grain-based distillery in our existing distillery complex at Muzaffarnagar. Both these distilleries are expected to be set up by the end of Q4 FY 22, and the total installed capacity would increase from 320 KLPD to 520 KLPD. Further, in view of the proposed expansion plans, the installed capacity would increase to 660 KLPD by the commencement of SS 2022-23.

The Company has been progressively increasing its distillation capacity to improve risk profile of its businesses and to reduce dependence on the cyclical sugar business. Further, as a forward integration and to effectively use reserved molasses, which are required to be sold to IMIL units at almost 1/4th of the market price of the C-Heavy molasses, the Company has set up a bottling plant to manufacture IMIL during the year.

Engineering Business Segment

Power Transmission Business (PTB)

₹ lakhs

Particulars	FY 21	FY 20	Change %
Turnover	13008	15422	-16%
PBIT (Segment Profit)	4091	4854	-16%
PBIT/Turnover (%)	31%	31%	

As a result of COVID-19 related issues and constraints, capital goods industry was impacted and there was a slowdown in new investments as well as expansion projects. It resulted in delayed order finalisation, reduced order intake and deferment of deliveries. Despite the aforesaid constraints, PTB business has done reasonably well with total exports increasing from 11% of the turnover in the previous year to 18% in the current year.

The Company is exploring new products, geographies and actively engaged with the Defence Sector to tap business opportunities for further growth and diversification. The Government of India's 'Make in India' initiative has led to new opportunities for diverse engineered products, and PTB's Mysuru facility is actively participating in many of these indigenous development projects. PTB is initially focussing on Naval Defence markets and has gained some foothold in the critical turbo pumps space.

Orders of ₹ 157.76 crore were received during the year. The outstanding order book as on March 31, 2021 stood at ₹ 166.23 crore including orders of ₹ 66.23 crore executable over a couple of years.

Water and Wastewater Treatment Business

₹ lakhs

Description	Standalone			Consolidated		
	FY 21	FY 20	Change %	FY 21	FY 20	Change %
Turnover	25060	29287	-14%	26074	30593	-15%
PBIT	1884	1349	40%	2674	2401	11%
PBIT/Turnover (%)	8%	5%		10%	8%	

The consolidated results include financial results of a wholly-owned subsidiary, Mathura Wastewater Management Private Limited (MWMPL), which is engaged in the execution of a project awarded by National Mission of Clean Ganga (NMCG) under Namami Gange programme for the city of Mathura, UP.

The turnover of WBG has declined by 14% to ₹ 250.60 crore but its segment profit has increased by 40% to ₹ 18.84 crore. Increase in profitability is due to efficient project execution which has led to overall cost savings.

The business operations of water business were impacted due to COVID-19 which had caused interruptions in the operations, including due to shortage of labour, and delay in finalisation of orders.

During the year, orders of ₹ 186.50 crore were received by the Company. The finalisation of several projects was delayed due to various disruptions. Orders in hand at the year end are at ₹ 912.02 crore (including long-term O&M contracts of ₹ 456.87 crore).

Water business has during the year secured an EPC Water Sewerage project of USD 22.80 million (₹ 156 crore) from Ministry of National Planning Housing & Infrastructure of Republic of Maldives funded by Exim Bank of India. WBG has a strong order pipeline and visibility of other projects to be tendered during the year, including projects on Hybrid Annuity Model in the municipal as well as private sector.

Review of Balance Sheet

Major changes in the Balance Sheet items are explained as hereunder:

Non-Current Assets

Property Plant and Equipment

During the year, there have been additions to the extent of ₹ 69.01 crore. Additions of ₹ 28.73 crore have taken place in the Distillery segment, including a new bottling plant for alcoholic beverages and balance capitalisation of incineration boiler at Muzaffarnagar. The additions of ₹ 35.71 crore has taken place in the Sugar business.

Capital Work-in-Progress

The Capital work-in-progress of ₹ 22.23 crore mainly comprises construction of sugar godown at Sabitgarh, and expenditure relating to new distilleries which are in the process of being commissioned.

Investments in Subsidiaries and Associates

Investments are lower at ₹ 41.95 crore as on 31.3.2021 as compared to ₹ 69.77 crore as on 31.3.2020 as investment of

₹ 30.06 crore in the associate company, Aqwise Wise Water Technologies Ltd ("Aqwise"), has been considered as "Assets held for sale" consequent to a Share Purchase Agreement signed for divestment of the equity stake held in Aqwise.

Income Tax Assets (net)

The income tax assets (net) represents amount receivable upon completion of the assessment and against various appeals decided in favour of the Company, the refund procedures of which are in progress. During the year, refunds of ₹ 31.20 crore were received.

Current Assets

Inventories

Inventories are lower by 9% at ₹ 1,733.75 crore as on March 31, 2021 due to 17% lower sugar inventories held in quantitative terms. Reduced inventory levels are, as a result of higher sugar sales volume (including exports), lower opening sugar inventory by 15% and diversion of higher sugar to B-heavy molasses.

Trade Receivables

Trade receivables are lower at ₹ 220.63 crore as on 31.03.2021 from ₹ 295.32 crore as on 31.3.2020. The receivables have reduced in Sugar and Co-generation by ₹ 36.24 crore and in Water business by ₹ 52.49 crore.

Other Current Assets

It has reduced to ₹ 269.35 crore as on March 31, 2021 from ₹ 437.54 crore as on March 31, 2020, mainly due to receipt of substantial amount of subsidies during the year – subsidies receivable from the Government have significantly reduced to ₹ 45.36 crore as on 31.03.2021 as compared to ₹ 235.14 crore as on 31.03.2020. It further includes customer retention of ₹ 106.83 crore pertaining mainly to Water Business.

Equity

Share Capital

The Company had during the year successfully completed buyback of 61.90 lakhs fully paid-up equity shares and the share capital has reduced correspondingly.

Other Equity

During the year, the reserves and surplus increased by ₹ 193.20 crore (16%) to ₹ 1,439.06 crore due to profit earned during the year and transferred to Retained Earnings, as reduced by premium of ₹ 64.38 crore paid on buyback of shares and expenses / tax of ₹ 15.44 crore incurred in connection with such buy-back.

Term Borrowings (Non-Current & Current)

Total long-term borrowings at the year-end, including current maturities of long-term borrowings, are at ₹ 382.09 crore as against ₹ 614.72 crore as at the end of the previous year. During the year, term loan repayments were made to the extent of ₹ 238.56 crore including prepayment of a term loan of ₹ 125 crore after the expiry of the interest subvention period. Almost all outstanding Term loans are at concessional interest rate or carry substantial interest subvention.

Current Liabilities

Borrowings

Short-term borrowings are lower at ₹ 561.57 crore as on 31.03.2021 as against ₹ 943.44 crore as on March 31, 2020. The utilisation is lower due to better working capital management resulting in lower sugar inventory held at the year end as well as surplus funds parked in the cash credit account.

Trade Payables

Trade payables are lower at ₹ 624.13 crore as on March 31, 2021 as against ₹ 756.40 crore as on 31.03.2020. It comprises cane dues of ₹ 520.07 crore as on 31.03.2021 as against ₹ 607.31 crore as on 31.03.2020.

Other Financial Liabilities

Other Financial liabilities are lower at ₹ 155.40 crore as on March 31, 2021 as against ₹ 200.79 crore as on March 31, 2020. The decrease is mainly owing to reduction in current maturities of long-term loans by ₹ 38.47 crore.

Other Current Liabilities

Other Current liabilities are higher at ₹ 164.26 crore as on March 31, 2021 as against ₹ 153.56 crore as on March 31, 2020. It includes liability of ₹ 80.76 crore to customers under construction contracts for Water Business in view of higher billing than revenue recognised based on work completion.

Key Financial Ratios

Ratios	Mar '21	Mar '20	Remarks	Formula used for ratios
Debtors Turnover	18.19	16.59	The ratio is higher as trade receivables have declined by 25% despite higher Revenue from Operations by 6%	Revenue from Operations/Average Trade Receivable
Inventory turnover	2.18	1.85	The ratio is higher on account of higher sales volume of sugar during the year and lower inventories held	Cost of Goods Sold / Average Inventory
Interest coverage	9.82	6.28	Improvement in the ratio is attributable to 35% reduction in the Finance Cost	PBIT/Finance Cost
Current ratio	1.44	1.28	Higher ratio is due to improved financial position as a result of improved cash flows, higher profitability, better working management and lower availment of short-term borrowings	Current Assets / Current Liabilities
Long Term Debt - Equity	0.26	0.48	The ratio is lower due to: (a) Long-term borrowings have reduced due to regular repayment /	Long Term Debt / Equity
Total Debt-Equity ratio	0.64	1.20	prepayment of loans, (b) Short-term borrowings are lower due to better working capital management and surplus funds parked in Cash Credit Accounts, and (c) increase in Equity due to higher profits transferred to reserves during the year	Total Debt (after Reducing Cash & Cash Equivalent) / Equity
Operating Profit Margin (%) (OPM)	10.83%	11.26%	OPM is slightly lower due to reduced margin in distillery segment owing to higher cost of molasses and incidence of certain non-recurring expenses	Operating Profit (PBIT)/ Revenue from Operations (net of excise duty)
Return on Net Worth (%)	20.56%	28.81%	Lower return is due to 17% lower Profit After Tax (PAT) owing to high tax incidence and exceptional items, and increased Equity due to profits generated during the year	PAT/ Networth Average (excluding Capital & Amalgamation Reserves)

RISK MANAGEMENT AND MITIGATION

The Company is engaged in multiple businesses and there are unique risks associated with each business. The Company follows a well-structured Enterprise Risk Management (ERM) Policy, which requires the organisation to identify the risks associated with each business and to categorise them based on their impact and probability of occurrence – at the business level and at the entity level. Mitigation plans are laid out for each risk along with designation of an owner thereof. It is the endeavour of the Company to continually improve its systems, processes and controls to improve the overall risk profile of the Company.

The ERM policy defines the risk parameters within which the businesses should operate. It helps to build a discipline within the organisation wherein all business decisions are taken after assessing the attendant risks and formulating effective mitigation plans to contain the impact of such risks. Since the Company is engaged in diversified businesses having completely different risk profiles, Risk Management Framework for each business has been devised considering its complexity and uniqueness. Sugar business of the Company is agro-based and is largely dependent on uncontrollable climatic factors and Government regulations and policies, whereas the Engineering business relates to capital goods and infrastructure sectors, which are dependent on the economic growth of the country.

Risk of Business Disruption due to COVID-19

Before dwelling on the normal business risks, it is imperative to evaluate the recent emergent risks as a result of COVID-19. The pandemic has brought about most unprecedented public health and socio-economic crisis across the globe. To check the spread of virus, the Government declared complete lockdown from March 25, 2020 till May 3, 2020 during which period only essential services were permitted to operate. Subsequently, the lockdown was relaxed in phases. Many sectors of the economy had been badly hit due to disruption in activities, lower demand, financial crunch, disruption in supply chain and reduced supply of labour.

The major business of the Company – Sugar along with Cogeneration and Distillery, being essential goods in nature, operated uninterrupted during the lockdown period with the active support of the State and Central Government in overcoming supply chain challenges. The demand of sugar and ethanol declined temporarily during the lockdown period but these were normalised within a few months.

The business operations of engineering business were impacted during the lockdown period due to the closure of the factory/project sites but these resumed normal operations by the middle of May 2020. In the subsequent few months, the activities were normalised but there was some loss of business due to inability of customers to take deliveries, delayed order finalisation / booking and restriction to travel and interact physically with customers. The business conditions were largely normalised by the 3rd quarter but the 2nd wave of the pandemic in the 4th quarter has again slowed down the process. There is some degree of uncertainty on when the full normalcy would return and until then, there would be greater reliance on IT tools to connect with customers and transact business to the extent practicable. Equally importantly, the health and welfare of employees and their families is important and the Company would be focussing on this area, including ensuring vaccination for all. It will help to minimise interruptions to the business.

SUGAR BUSINESS

Sugar business is exposed to significant external risks, which mostly are uncontrollable and thus, it is imperative to optimise the controllable business productivity and efficiencies on a dynamic basis to counteract the impact of such external risks. The internal risks are moderate and are by and large predictable and manageable.

It is the objective of the Company to be amongst the top performers in UP, much above the average, so that it remains less impacted by the cyclicity associated with this industry. During SS 2020-21, the Company has achieved recovery of 11.86% (after adjustment of B-heavy molasses) – 44 basis points higher than the average recovery achieved in Uttar Pradesh.

Some of the key external risks to which the Sugar business is exposed are described herein below:

Risk of over dependence on Government's policies and support

Risk of sugar production in excess of domestic consumption

The all India production in SS 2020-21 is expected at ~30.9 million tonnes, which is 12% higher than the previous season and against domestic consumption of ~ 26 million tonnes. With opening sugar inventories of 10.7 million tonnes, excess of production over consumption by 4.9 million tonnes, the sugar inventories may further increase unless the surplus stocks are exported. It will lead to higher inventory holdings, increased working capital requirements, higher finance costs and liquidity constraints.

Mitigation

The Government has been actively promoting export of sugar for the last several years to evacuate surplus sugar and provides subsidy to undertake exports. It has again introduced a scheme for exports up to 6 million tonnes for the SS 2020-21 along with export subsidies. Pursuant to the scheme, the target exports are expected to be achieved and in view of firm international prices, the actual exports may exceed the target by up to one million tonnes, which will be without export subsidies. Thus, the sugar inventories at the end of SS 2020-21 are expected to decline by around 2 million tonnes, which augurs well for the sugar prices and working capital management.

The Government has been supporting production of Ethanol by using B-heavy molasses and sugarcane juice which results in diversion of sugar. The diversion of sugar is estimated at ~ 2 million tonnes in SS 2020-21 and will progressively increase as further distillation capacities are set up to achieve Government's target of 20% Ethanol blending by the year 2025.

Pursuant to such policies, our Company has exported significant sugar in FY 21, equivalent to 22% of the production during the year and produced 56% Ethanol from B-heavy molasses. Consequently, the sugar inventory as on March 31, 2021 is 17% lower than the previous year.

As sugarcane prices are unrealistically high, it may not be feasible to compete in the world market on costs without export subsidies. Hence, diversion of sugar for ethanol production is a useful mechanism to achieve fuel security along with maintaining optimal sugar stocks.

Sugar Price Risk**Risk**

The sugar prices have significant impact on the profitability and viability of the sugar mills. In the event, the prices go below the break-even levels, losses may be inflicted which may have material impact on the financial position of the company to manage its operations, including payment of cane dues and to service debts.

Mitigation

There are various mitigations available against this key risk, internally and externally:

- a) The Government announces monthly quota for sale in the domestic market which ensures meeting demand adequately without any excessive supplies. Resultant, the prices remain range bound and excessive volatility is avoided.

- b) The Government has prescribed Minimum Selling Price (MSP) of sugar below which sugar mills are not permitted to sell sugar. This mechanism avoids collapse in the sugar prices due to overproduction in the country or temporarily excessive supplies in the market.
- c) The Company has been focussing on improvement of recoveries as these lead to low cost of production of sugar and enables the sugar mill to tide over market variation in sugar prices and make the sugar operation profitable. The recoveries of our Company have significantly improved over the last few years.
- d) The Company produces premium quality sugar to increase overall realisation prices, such as, refined sugar equivalent to ~40% of its production and pharmaceutical grade sugar which fetch substantial premium over plantation white sugar. Additionally, the Company also sells ~11% of sugar through institutional buyers to maintain quality, avoid overdependence on sugar agents and to enhance overall realisation price.
- e) The sugar business of the Company comprises optimal mix of cogeneration and distillation and because of diversified revenue streams, it is in a better position to meet and overcome various risks.

Risk of increase in sugarcane price**Risk**

The cane price in Uttar Pradesh has remained unchanged for the last four years and it is possible that the cane price may increase in the forthcoming SS 2021-22, also in view of state elections to be held next year. The increase in cane price may have significant impact on the financial position of the Company unless it is compensated by commensurate increase in sugar prices.

Mitigation

It is believed that along with increase in cane price, the Government may also increase MSP of sugar to mitigate its impact on the financials of the sugar industry. If the additional cost is lumped on the industry, it will impact its cane price paying capacity and the purpose of increasing cane price will get defeated.

Risk of Climatic factors:**Risk**

The climatic factors, such as, monsoon, flood, drought and crop diseases impact the yield and sugar recovery from cane. Lower yields result in lower cane availability to sugar mills whereas lower sugar recovery leads to higher cost of production.

Mitigation

During SS 2020-21, the yields and recoveries in the State of U.P. have declined due to climatic factors and accordingly, sugar production in U.P. was lower by 12.6%. However, decline in the sugar production was only 7% for the Company as it performed better than the state average. The impact of climatic factors is moderate in Uttar Pradesh due to large irrigated areas, as compared to other monsoon dependent sugarcane producing states, such as, Maharashtra and Karnataka. Further, the cane staff of the Company are quite vigilant and after the sowing season, they closely monitor the growth of sugarcane and disease infestation, so that timely action could be taken to avoid or minimise the damage.

ENGINEERING BUSINESS

The Power Transmission business and Water businesses are in the capital goods and infrastructure sectors and are largely dependent on the industrial and general economic conditions in the country which regulate demand of the products of our Engineering businesses. These businesses are exposed to the following major risks:

Risks

Risk of economic slowdown

Slowdown in the economy results in sluggish demand of the products of the user industries, which in turn has adverse effect on investment spend on capital goods required for capacity creation or modernisation.

Scarcity of funds

The sluggish demand puts financial stress on the industrial companies and in view of stressed financials and risk aversion, the lenders generally subject the projects to stringent diligence before arriving at funding decisions. The user industries are forced to defer their expansion plans in view of delay in funding, resulting in poor off-take of capital goods.

Technology risks

It is extremely vital for the Engineering business to offer technology and benchmark efficiencies at par with the competition and in the event of a significant gap in its offerings as compared to its peers, the customers may not prefer the products of the Company.

Project delays and payment risks

On account of financial problems with customers, including non-achievement of financial closure, the project may get delayed, resulting in credit risks, cost overruns and blockage of working capital.

Mitigations

Power Transmission Business (PTB)

PTB has fared well in FY 21, given the scale of challenges and constraints it faced due to COVID-19. Order booking during the year was almost at the same level as last year, which is an indication of normalisation of its business activities. The business model of Power Transmission Business is robust with main verticals being supply of Gear boxes to OEMs and Aftermarket services, including retrofitting and refurbishment solutions, with a focus to expand export footprints. The Company is working on new areas, such as manufacturing of gear internals to other OEMs under 'Built-to-Print' and foray into Defence sector with a range of engineered products which are aligned to 'Make in India' initiative. The diversified business model will enable Power Transmission Business to avoid overdependence on few sectors and withstand sector specific cyclicality.

Water Business Group (WBG)

The order book of Water business is healthy and despite its operations getting impacted during the financial year due to COVID-19, it has reported satisfactory results. The order intake had been subdued though, in view of delayed finalisation of orders. In view of strong pipeline of projects to be tendered and orders under finalisation, substantial orders are expected to be secured in FY 22 unless the impact of second wave of the pandemic is not prolonged.

The Company has an access to almost all technologies which are required to be deployed in various projects within the range and competence of the Company. The Company does proper diligence on its customers prior to accepting any order, which includes evaluating its financials, ensuring financial closure of the project, credit ratings (if any), track record and market feedback, and continues to closely monitor any financial stress which the customer may be subject to during the execution of the project.

Directors' Report

Your Directors have pleasure in presenting the 85th Annual Report and audited financial statements for the Financial Year (FY) ended March 31, 2021.

FINANCIAL RESULTS

(₹ in Lakhs)

Particulars	Standalone		Consolidated	
	2020-21	2019-20	2020-21	2019-20
Revenue from operations (Gross)	469320.49	442357.18	470335.14	443663.22
Operating Profit (EBITDA)	58422.73	57283.31	58860.45	57944.71
Finance cost	5143.70	7931.70	5163.17	7933.13
Depreciation and Amortisation	7908.76	7489.12	7908.76	7489.12
Profit before exceptional items & tax	45370.27	41862.49	45788.52	42522.46
Exceptional Items	(2183.14)	282.04	66.95	0.00
Profit before Tax	43187.13	42144.53	45855.47	42522.46
Tax Expenses	15856.27	9396.01	16516.24	11049.25
Profit after Tax, before Share of Net Profit of Associates	27330.86	32748.52	29339.23	31473.21
Share of net profit of Associates	-	-	121.04	2038.61
Profit for the year	27330.86	32748.52	29460.27	33511.82
Other comprehensive income (net of tax)	(28.86)	(96.19)	(60.74)	(282.35)
Total comprehensive income	27302.00	32652.33	29399.53	33229.47
Earning per equity share of ₹ 1 each (in ₹)	11.14	13.01	12.01	13.32
Retained Earnings brought forward	54533.68	25093.73	60790.80	30599.11
Appropriation:				
- Equity Dividend (including dividend distribution tax)	-	3288.03	-	3288.02
- Amount transferred to/ (from) molasses storage fund reserve (net)	40.49	(75.65)	40.49	(75.65)
Retained earnings carried forward	81795.19	54533.68	90205.90	60790.80

No material changes and commitments affecting the financial position of the Company have occurred between the end of the financial year of the Company to which these financial statements relate and the date of this report.

PERFORMANCE RESULTS

During the year, we witnessed unprecedented challenges caused by one of the worst pandemics, Covid-19, which not only threatened the public health but also caused socio economic crisis of the magnitude not witnessed before. It is a matter of achievement and satisfaction that your Company was able to withstand the challenges and came out with an encouraging performance under challenging conditions.

In respect of Sugar business, the manufacturing operations were not much affected due to Covid-19 even in the initial

months of the lockdown as its main products – Sugar and Ethanol – were considered essential products and with effective management and cooperation of governmental authorities, the operating challenges were overcome. However, there was an impact on sugar consumption during the initial period of lockdown owing to the closure of establishments / factories of institutional buyers but the normal consumption was soon restored. Likewise, in the case of Distillery also, temporary decline in fuel consumption posed challenges to ethanol offtake but it was managed due to the help and cooperation of oil marketing Companies and additional depots were allocated to maintain our contractual supplies.

While in the engineering business, the factories and project sites were made to close for a brief period, it took several months for the restoration of normalcy in supply chain and

business operations. Consequently, order finalization / booking was impacted and in some cases, contractual deliveries were also delayed.

Turnover for the year increased by 6% to ₹ 4693.20 crores. Operating profit is 2% higher at ₹ 584.23 crores and profit before exceptional items is higher by 8% at ₹ 453.70 crores.

Exceptional items comprise an impairment charge in respect of equity investment in the associate Company, Aqwise-Wise Water Technologies Ltd ("Aqwise"). The Company signed a Share Purchase Agreement dated March 25, 2021 for divesting its stake in Aqwise and accordingly, based on estimated consideration to be received, an impairment loss of ₹ 23.20 crores was recognized.

Profit after exceptional items is 2% higher at ₹ 431.87 crores. During the year, effective tax rate was higher as in the previous year, deferred tax charge was lower by ₹ 40.60 crores due to remeasurement of deferred tax liability (net) which was expected to reverse in the future when the Company would have shifted to the new tax regime pursuant to section 115BAA of the Income Tax Act, 1961. In view of high tax incidence, profit after tax is 17% lower at ₹ 273.31 crores. As the Company has exhausted all MAT credit and certain exemptions /deductions, it may be subject to lower tax rates under new tax regime for the subsequent periods.

The performance of the Sugar business (including Distillery) has done well as segment profit has increased by 2% over the previous year. It is commendable for the Engineering business to almost maintain their profitability, which is 4% lower than the previous year, despite various challenges relating to the impact of the pandemic.

The Company is financially much stronger with comfortable liquidity position and most importantly, almost all the term loans are at concessional rate of interest with cost of funds during the year at 5.00%. The total borrowings of the Company has declined by 39% due to efficient working capital management and Total Debt Equity ratio stands at 0.64 despite the fact that peak build of sugar inventory takes place at the year end.

The Company has been progressively increasing its distillation capacity to improve risk profile of its businesses and to insulate from cyclicity in the sugar business. Further, as a forward integration and to effectively use reserved molasses, which are required to be sold to country liquor units at almost 1/4th of the market price of the C-heavy molasses, the Company has set up a bottling plant to manufacture country liquor.

If the impact of second and third wave of pandemic does not spiral out of control, we expect normal business conditions to prevail in the second half of 2022.

BUSINESS OPERATIONS AND FUTURE PROSPECTS

Sugar Business (including Cogeneration):

Sugar business has achieved 7% higher turnover at ₹ 4063.11 crores with segment profit of ₹ 374.50 crores, which is 5% higher than the previous year. The increase in profitability is attributed to improved margins, particularly in exports.

Season 2020-21 in Uttar Pradesh ("UP") was characterized by general trend of lower yield and recovery due to climatic factors. Accordingly, crush in UP during the season has declined by 8.20% as compared to the previous season and the average recovery of the state was 18 basis points lower than the previous year. However, the performance of our sugar business has been better than the average for UP – the crush was 2% lower and the recovery (after adjustment of B-heavy molasses) was 11 basis points lower than the previous season

All India production in the season 2020-21 is expected at 30.9 million tonnes as compared to 27.4 million tonnes in the previous season. It must be said to the credit of the Government that it continued with its export Policy, albeit with lower subsidy, and announced support to exports up to 6 million tonnes. The export target is likely to be easily met and in view of firm international sugar prices, it is possible that more sugar exports up to one million tonne may take place even without subsidy. It augurs well for the domestic sugar prices as stocks of 10.7 million tonnes at the opening of sugar season 2020-21 may get further liquidated by about 2 million tonnes.

Under the Maximum Admissible Export Quota (MAEQ) of sugar season 2020-21, the exports of 181858 tonnes were allocated to the Company and the entire obligation has already been discharged. We have fully utilized the export policy of the Government of India ("GoI") which has helped us to manage our working capital effectively.

During the year, B-Heavy molasses were produced by four sugar units right from the beginning of the sugar season 2020-21 and one more sugar unit started production of B-Heavy molasses later in the season. As a result of production of B-Heavy molasses, we have been able to divert 75148 tonnes of sugar during the sugar season 2020-21. As we would be adding further distillation capacities, higher percentage of sugar will be diverted for the manufacture of ethanol.

Cane price in the sugar season 2020-21 remained unchanged from the previous season, which is a matter of reprieve to the sector as much awaited increase in Minimum Selling price (MSP) of sugar is still awaited despite its being recommended by Group of Ministers in July, 2020.

Cogeneration operations have been merged with the sugar operation as it no longer qualifies to be a separate operating segment.

Distillery:

Turnover of Distillery Segment increased by 39% to ₹ 543.76 crores during the year. It is on account of full year impact of the new distillery which was set up in the previous year and also due to higher operational days due to the installation of incineration boilers. Consequently, the production has increased by 14% during the year and sales volume by 23%. Segment profits, however, are lower by 9% due to increased cost of molasses and a non-recurring charge in view of discarding of certain fixed assets upon installation of incineration boiler at the old distillery at Muzaffarnagar. Currently, our distillation capacity is 320 KLPD and we are proposing to set up a dual feed 160 KLPD Distillery at our Sugar unit at Milak Narayanpur which can use sugarcane juice/grain as feedstock along with B-Heavy molasses to produce ethanol and another 40 KLPD grain based distillery in our existing distillery complex at Muzaffarnagar. Both these distilleries are expected to be set up by the end of Q4 FY 22 and the total installed capacity would increase from 320 KLPD to 520 KLPD. Further, in view of the proposed expansion plans, the installed capacity would increase to 660 KLPD by the commencement of sugar season 2022-23.

Engineering Business:

Turnover of the Engineering business comprising Power Transmission business (PTB) and Water Business Group (WBG) has declined by 15% with segment profits declining by only 4% due to pandemic related issues.

Power Transmission Business (PTB)

During the year, the Company has re-designated the 'Gears Business' as the 'Power Transmission Business', which is a more accurate representation of the present business.

The turnover of PTB has declined by 16% to ₹ 130.08 crores whereas its segment profit has declined by 16% to ₹ 40.91 crores. The decline in business activities is mainly due to the impact of Covid-19 which has affected capital goods industry and has slowed down new as well as on-going projects. It is heartening to note that during the year, total exports, mainly to OEMs, have increased to 18% of the total turnover from 11% in the previous year. Further, orders of ₹ 157.76 crores have been received during the year, which are slightly more than the previous year, with long tenure orders of ₹ 13.61 crores. It is an indication that order position is getting normalized which will help the business to return to its growth trajectory.

The Government of India's 'Make in India' initiative has led to new opportunities for diverse engineered products,

and PTB's Mysuru facility is actively participating in many of these indigenous development projects. The Defence Procurement Policy 2020 focusses on self-reliance for various equipment in design, development and manufacture by the Indian Industry. Most of the new projects envisaged by the Defence sector are customised requirement for critical equipment, offering substantial value to the existing portfolio of PTB's rotating machinery. PTB is initially focusing on Naval Defence markets and has gained some foothold in the critical turbo pumps space.

PTB has collaborated with global OEMs for precision manufacturing of components for wind gearboxes as well as industrial high-speed compressor gears, helping the business to enhance capacity utilisation productively. This segment offers high potential for growth for exports in the medium to long term. The new segment of compressor gears, which the Company entered in the last few years with leading OEMs, is expected to show growth in the coming years from domestic and export markets.

Water Business Group

The turnover of WBG has declined by 14% to ₹ 250.60 crore but its segment profit has increased by 40% to ₹ 18.84 crore. Increase in profitability is due to efficient project execution which has led to overall cost savings. The decline in business activities as well as order booking is due to the impact of Covid-19 which had caused interruptions in the operations, including due to shortage of labour, and delay in finalization of orders.

Water business has recently secured an EPC project of Water Sewerage project of US\$ 22.80 million (₹ 156 crores) from Ministry of National Planning Housing & Infrastructure of Republic of Maldives funded by Exim Bank of India. WBG business sees potential business opportunities as significant value of bids are expected to be finalised with respect to EPC and HAM projects. We have been enthused by the experience of our first HAM project awarded to us for the city of Mathura. It is proceeding well and we would try to secure more such contracts.

DIVIDEND

Your Board of Directors are pleased to recommend a dividend of ₹ 1.75 per equity share (175 %), involving total outgo of ₹ 42.31 crore, which is subject to shareholders' approval in the ensuing Annual General Meeting.

DIVIDEND DISTRIBUTION POLICY

As per the provision of Regulation 43A of Securities and Exchange Board of India (Listing Obligations and Disclosure Requirements) Regulations, 2015 ("Listing Regulations"), the Company had formulated a Dividend Distribution Policy.

The said policy was adopted to set out the parameters and circumstances that will be taken into account by the Board in determining the distribution of dividend to the shareholders of the Company and to retain profits earned by the Company. The Policy is available on the website of the Company at <http://www.trivenigroup.com/investor/corporate-governance/policies.html>.

SUBSIDIARY AND ASSOCIATE COMPANIES PERFORMANCE

Associate Companies

Triveni Turbine Ltd. (TTL)

TTL is engaged in the manufacture and design of steam turbines up to 30 MW and delivers robust, reliable and efficient end-to-end solutions. The higher range – above 30 MW to 100MW – is addressed through GE Triveni Limited (“GETL”), a Joint Venture with GE. The Company holds 21.85% stake in the equity shareholding of TTL. On a consolidated basis, TTL has achieved a net turnover and profit after tax (PAT) of ₹ 702.58 crore and ₹ 102.46 crore respectively as against ₹ 817.87 crore and ₹ 121.78 crore in the previous year. The performance results had been impacted due to the impact of the pandemic – in domestic as well as in export market. TTL has established itself as an international player and during the year, exports constituted 46% of the total turnover.

Certain disputes have arisen between TTL and the Joint Venture Partner in GETL and these are presently subjudice.

Aqwise-Wise Water Technologies Ltd. (Aqwise)

The Company held 25.04% in the equity capital of Aqwise. The business and the operations of the Company were significantly impacted due to COVID-19 and significant funding was required to normalize its operations. All the existing shareholders of Aqwise, including the Company, were inclined to divest their shareholdings in Aqwise and accordingly, a deal was struck with an Israel based company (“Buyer”) for divestiture of the entire shareholding in Aqwise in its favour. Consequently, a Share Purchase Agreement was signed on March 25, 2021.

For the year ended March 31, 2021, equity investments in the associate Company are being shown as “Assets for sale” and accordingly, based upon estimated consideration receivable, an impairment charge has been considered to the extent of ₹ 23.20 crores. The shares held by the Company in the associate company will be transferred to the Buyer after fulfilling the prescribed conditions / formalities in accordance with terms of the Share Purchase Agreement and accordingly it will cease to be an associate company.

Subsidiary Companies

During the year under report, two new companies namely, Triveni Foundation (Section 8 Company) and Gaurangi Enterprises Limited were incorporated as wholly owned subsidiaries of the Company. Further, the Company acquired 100% equity stake in United Shippers & Dredgers Limited (USD) from the existing shareholders of USD. With this acquisition, USD has also become a wholly owned subsidiary of your Company.

As on March 31, 2021, the Company has ten wholly owned subsidiaries as detailed in **Annexure-A**. All these companies except Mathura Wastewater Management Private Limited (MWMPL), are relatively much smaller and there has not been any material business activities in these companies. MWMPL is engaged in “Development of Sewage Treatment Plants and Associated Infrastructure on Hybrid Annuity PPP basis at Mathura, Uttar Pradesh” under the Namami Gange Programme. During the year under review, MWMPL achieved revenue and profitability (PBT) of ₹ 92.64 crores and ₹ 8.19 crore respectively.

As required under the provisions of Section 129 of the Companies Act, 2013 read with Companies (Accounts) Rules, 2014, a statement containing salient features of the financial statement of subsidiaries and associates is provided in the prescribed format AOC-1 as **Annexure-A** to the Board’s Report.

In accordance with the Regulation 16 of the Listing Regulations, none of the subsidiaries of this Company is a material non-listed subsidiary. The Company has formulated a policy for determining material subsidiaries. The policy has been uploaded on the website of the Company at <http://www.trivenigroup.com/investor/corporate-governance/policies.html>.

CONSOLIDATED FINANCIAL STATEMENTS

In compliance with the provisions of Companies Act, 2013 and Indian Accounting Standards (Ind AS) as specified in Section 133 of the Act and Regulation 34 of the Listing Regulations, your Directors have pleasure in attaching the consolidated financial statements of the Company which form a part of the Annual Report.

Financial Statements including consolidated financial statements and the audited accounts of each of the subsidiary are available on the Company’s website <https://www.trivenigroup.com/financials>.

DIRECTORS RESPONSIBILITY STATEMENT

Pursuant to Section 134(5) of the Companies Act, 2013, your directors confirm that:

- a) in the preparation of the annual accounts for the financial year ended March 31, 2021, the applicable accounting standards have been followed and there are no material departures;
- b) the directors have selected such accounting policies and applied them consistently and made judgments and estimates that are reasonable and prudent so as to give a true and fair view of the state of affairs of the Company at the end of the financial year and of the profit of the Company for that year;
- c) the directors have taken proper and sufficient care for the maintenance of adequate accounting records in accordance with the provisions of the Companies Act, 2013 for safeguarding the assets of the Company and for preventing and detecting fraud and other irregularities;
- d) the directors have prepared the annual accounts on a going concern basis;
- e) the directors have laid down internal financial controls to be followed by the Company and that such internal financial controls are adequate and were operating effectively; and
- f) the directors have devised proper systems to ensure compliance with the provisions of all applicable laws and that such systems were adequate and operating effectively.

BUYBACK OF EQUITY SHARES

Pursuant to the approval of the Board on August 10, 2020 your Company completed buyback of 61,90,000 fully paid-up equity shares of the face value of ₹ 1/- each of the Company for an aggregate amount of ₹ 64,99,50,000/- (Rupees Sixty Four Crores Ninety Nine Lakhs Fifty Thousand only) (excluding transaction costs), being 5.03% of the aggregate of the Company's paid-up capital and free reserve (including securities premium) based on the consolidated financial statements of the Company for FY20, at a price of ₹ 105/- per equity share in October, 2020. The buyback was made from all existing shareholders of the Company as on August 28, 2020, being the record date for the purpose, on a proportionate basis under the tender offer route in accordance with the provisions contained in the Securities and Exchange Board of India (Buy Back of Securities) Regulations, 2018 and the Companies Act, 2013 and rules made thereunder. The shares accepted under the buyback have been extinguished and the paid-up equity share capital of the Company has been reduced to that extent.

CORPORATE GOVERNANCE

In accordance with the Listing Regulations, a separate report on Corporate Governance is given in **Annexure-B** along with the Auditors' Certificate on its compliance in **Annexure-C** to the Board's Report. The Auditors' Certificate does not contain any qualification, reservation and adverse remark.

RELATED PARTY CONTRACTS / TRANSACTIONS

The Company has formulated a Related Party Transaction Policy, which has been uploaded on its website at <http://www.trivenigroup.com/investor/corporate-governance/policies.html>. It is the endeavour of the Company to enter into related party transaction on commercial and arms' length basis with a view to optimise the overall resources of the group.

All transactions entered into with related parties during the year were in the ordinary course of business of the Company and at arms' length basis. The Company has not entered into any contract/arrangement/transactions with related parties which could be considered material in accordance with the Policy of the Company on the materiality of related party transactions. Form AOC-2 is not attached with this report as there was no such related party transaction for which disclosure in terms of Section 134(3)(h) of the Companies Act, 2013 read with Rule 8(2) of the Companies (Accounts) Rules, 2014 is required.

RISK MANAGEMENT POLICY AND INTERNAL FINANCIAL CONTROL

The Company has a risk management policy, the objective of which is to lay down a structured framework for identifying potential threats to the organisation on a regular basis, assessing likelihood of their occurrence, designate risk owners to continually evaluate the emergent risks and plan measures to mitigate the impact on the Company, to the extent possible. The framework and the system are reviewed from time to time to enhance their usefulness and effectiveness. The policy recognizes that all risks in the business cannot be eliminated but these could be controlled or minimized through effective mitigation measures, effective internal controls and by defining risk limits.

A comprehensive Risk Management Framework has been put in place for each of the businesses of the Company which is stringently followed for the management of risks, including categorisation thereof based on their severity. Such categorisation gives highest weightage to the risks which have the potential to threaten the existence of the Company. The risks with higher severity receive more attention and management time and it is the endeavour of the Company to strengthen internal controls and other mitigation measures on a continuous basis to improve the risk profile of the Company.

Risk Management System has been integrated with the requirements of internal controls as referred to in Section 134(5)(e) of the Companies Act, 2013 to evolve risk related controls. Detailed internal financial controls have been specified covering key operations, to safeguard of assets, to prevent and detect frauds, to ensure completeness and accuracy of accounting records, to ensure robust financial reporting and statements and timely preparation of reliable financial information. These are achieved through Delegation of Authority, Policies and Procedures and other specifically designed controls, and their effectiveness is tested regularly as per the laid out mechanism as well as through external agencies.

DIRECTORS AND KEY MANAGERIAL PERSONNEL (KMP)

As per the provisions of the Companies Act, 2013 ('Act'), Mr Tarun Sawhney, Vice Chairman and Managing Director will retire by rotation at the ensuing Annual General Meeting ('AGM') of the Company and being eligible, seeks re-appointment. The Board has recommended his re-appointment.

The Board of Directors had, on recommendation of the Nomination & Remuneration Committee, appointed Mr. Ajay Kumar Relan as Additional Director in the capacity of Independent Director for initial term of five years with effect from June 29, 2021, subject to approval of the shareholders. In the opinion of the Board, Mr. Relan is a person of integrity and possesses relevant expertise and experience. The Board has recommended his appointment.

Mr Shekhar Datta, Non-Executive Independent Director resigned from the directorship of the Company with effect from the close of Board meeting held on June 29, 2021 and the Board's Committees of which he was a member viz. Audit Committee and Nomination & Remuneration Committee due to advancing age and health condition. There was no other material reason for his resignation. The Board places on record its highest appreciation for the valuable services rendered and guidance provided by Mr. Datta during his tenure as a Director of the Company.

The Company has received declarations of independence in terms of Section 149 of the Act and also under the Listing Regulations from all the Independent Directors and the same has been taken on records by the Board of Directors.

As required under the provisions of Section 203 of the Act, the Key Managerial Personnel, namely, Vice Chairman & Managing Director, CFO and Company Secretary continue to hold that office as on the date of this report.

EMPLOYEES STOCK OPTION

There are no outstanding stock options and no stock options were either issued or allotted during the year under TEIL ESOP 2013.

AUDITORS

Statutory Audit

M/s S.S. Kothari Mehta & Co. (SSKM), Chartered Accountants (FRN: 000756N) were appointed as Statutory Auditors of the Company at the 81st AGM to hold office for a period of five consecutive years from the conclusion of that AGM until the conclusion of 86th AGM of the Company to be held in the year 2022.

Cost Audit

In terms of the provisions of Section 148 of the Companies Act, 2013 read with the Companies (Audit and Auditors) Rules, 2014 and the Companies (Cost Records and Audit) Rules, 2014 duly amended, Cost Audit is applicable to the Sugar and Power transmission businesses of the Company for the FY 2021-22. The Company has been maintaining cost accounts and records in respect of the applicable products. Mr Rishi Mohan Bansal and M/s GSR & Associates, Cost Accountants have been appointed as Cost Auditors to conduct the cost audit of the Sugar businesses (including cogeneration and distillery) and Power transmission business respectively of the Company for the FY 2021-22, subject to ratification of their remuneration by the shareholders at the ensuing Annual General Meeting. The Board recommends the ratification of the remuneration of the Cost Auditors for the FY 22.

COMMENTS ON THE AUDITOR'S REPORT

Statutory Audit

The Auditors report for the financial year 2020-21 does not contain any qualification, reservation or adverse remark. Further pursuant to section 143(12) of the Act, the Statutory auditors of the Company has not reported any instances of fraud committed in the Company by its officers or employees, the details of which are required to be mentioned in the Board's Report.

In the Para i (c) of Annexure A to the Auditors Report, the auditor has reported that the title deeds of certain immovable properties are not held in the name of the Company. During the year, the Company has resolved many such cases. The total area and cost thereof involved in remaining cases are not material. The transfer of land in the name of the Company in few cases could not be completed on account of certain technicalities / documentary deficiencies, which the Company is trying to resolve to the extent feasible. However, in all these cases, the land continues to remain in the possession of the Company."

The cases pointed out by the Auditors in Para iii (b) of Annexure A to the Auditors report are self-explanatory. The loan could not be repaid by the associate company in time due to liquidity constraints, arising mainly from the impact of Covid-19 on the operations and business of the company. The Company has entered into a Share Purchase Agreement on March 25, 2021 to divest its stake in the associate company and accordingly, all such loans have been settled.

Secretarial Audit

In terms of Section 204 of the Companies Act, 2013 read with the Companies (Appointment and Remuneration of Managerial Personnel) Rules, 2014, the Board appointed M/s Suresh Gupta & Associates, a firm of Company Secretaries in practice to undertake the Secretarial Audit of the Company for FY21. The report on secretarial audit is annexed as **Annexure-D** to the Board's report. The report does not contain any qualification, reservation or adverse remark.

DISCLOSURES

Corporate Social Responsibility (CSR)

A revised CSR Policy has been formulated by the CSR Committee pursuant to recent amendment in the Companies (Corporate Social Responsibility Policy) Rules, 2014, which, on its recommendation, was approved by the Board. The revised CSR Policy is available on the Company's website at <http://www.trivenigroup.com/investor/corporate-governance/policies.html>.

The composition of the CSR Committee and Annual Report on CSR activities during FY21, as recommended by the CSR Committee and approved by the Board, is provided in **Annexure-E** to the Board's report.

AUDIT COMMITTEE

The composition of Audit Committee is provided in the Corporate Governance Report that forms part of this Annual Report.

VIGIL MECHANISM

The Company has established a vigil mechanism through Whistle Blower Policy and it oversees the genuine concerns expressed by the employees and other directors through the Audit Committee. The vigil mechanism also provides for adequate safeguards against victimization of employees and directors who may express their concerns pursuant to this policy. It has also provided direct access to the Chairperson of the Audit Committee in appropriate or exceptional cases. The policy is uploaded on the website of the Company at <http://www.trivenigroup.com/investor/corporate-governance/policies.html>.

DISCLOSURE UNDER THE SEXUAL HARASSMENT OF WOMEN AT WORKPLACE (PREVENTION, PROHIBITION AND REDRESSAL) ACT 2013

The Company has an Anti-Sexual Harassment Policy in line with the requirements of Sexual Harassment of Women at Workplace (Prevention, Prohibition and Redressal) Act 2013. Further, the Company has complied with the provisions relating to the constitution of Internal Complaints Committee under the said Act. No complaint was received by the Internal Complaints Committee during FY21.

BOARD MEETINGS

During the year, seven board meetings were held, the details of which are provided in the Corporate Governance Report that forms part of this Annual Report. The maximum interval between the two meetings did not exceed 120 days as prescribed under the Companies Act, 2013 and the Listing Regulations.

PARTICULARS OF LOANS, GUARANTEES OR INVESTMENTS MADE UNDER SECTION 186 OF THE COMPANIES ACT, 2013

Notes 6 and 9 of the standalone financial statements of the Company forming part of the Annual Report provide particulars of the investments made by the Company in the securities of other bodies corporate; Notes 8 and 48 provide details of loans advanced; and, Note 39 (v) provides details of guarantee given by the Company.

CONSERVATION OF ENERGY, TECHNOLOGY ABSORPTION, FOREIGN EXCHANGE EARNINGS AND OUTGO

The particulars required under Section 134(3)(m) of the Companies Act, 2013 read with the Companies (Accounts) Rules, 2014 are provided in **Annexure-F** to the Board's report.

PARTICULARS OF EMPLOYEES

The information as required under Section 197 of the Companies Act, 2013 read with Rule 5(1) of the Companies (Appointment and Remuneration of Managerial Personnel) Rules, 2014 is provided in **Annexure-G** to the Board's Report.

The particulars of employees drawing remuneration in excess of limits set out in the Rule 5(2) of Companies (Appointment and Remuneration of Managerial Personnel) Rules, 2014 are provided in **Annexure-H** to the Board's Report. However, as per the provisions of Section 136 of the Companies Act, 2013, the annual report is being sent to all the members of the Company excluding the aforesaid information. The said information is available for inspection by the members at the registered office of the Company up to the date of the ensuing Annual General Meeting. Any member interested in obtaining

such particulars may write to the Company Secretary at the registered office of the Company.

MANAGEMENT'S DISCUSSION AND ANALYSIS

In terms of the provisions of Regulation 34 of the Listing Regulations, the Management Discussion and Analysis is set out in this Annual Report.

BUSINESS RESPONSIBILITY REPORT

The Listing Regulations mandate top 1000 listed entities based on the market capitalization as on March 31 of every financial year the inclusion of the Business Responsibility Report as part of the Directors' Report of the Company. The report in the prescribed form is annexed as **Annexure-I** to the Board Report.

SECRETARIAL STANDARDS

The Company has devised proper systems to ensure compliance with the provisions of all applicable Secretarial Standards issued by the Institute of Company Secretaries of India and that such systems are adequate and operating effectively.

DEPOSITS

The Company has not accepted any public deposits under Section 73 of the Companies Act, 2013.

DEBENTURES

No debentures were issued during the period under review.

ANNUAL RETURN

Pursuant to Section 92(3) of the Companies Act, 2013, the annual return for the financial year 2020-21 is available on website of the Company i.e. <https://www.trivenigroup.com/shareholders-information>.

SIGNIFICANT AND MATERIAL ORDERS

There are no significant and material orders passed by the regulators or courts or tribunal impacting the going concern status and Company's operations in future.

HUMAN RESOURCES

Your Company believes and considers its human resources as the most valuable asset. The management is committed to provide an empowered, performance oriented and stimulating work environment to its employees to enable them to realise their full potential. Industrial relations remained cordial and harmonious during the year.

POLICY ON DIRECTORS' APPOINTMENT AND REMUNERATION

The policy of the Company on Directors' appointment and remuneration, including criteria for determining qualifications, positive attributes, independence of a director and other matters provided under sub-section (3) of Section 178 of the Companies Act, 2013 and the Listing Regulations, adopted by the Board is available on the website of the Company at <http://www.trivenigroup.com/investor/corporate-governance/policies.html>.

BOARD EVALUATION MECHANISM

Pursuant to the provisions of Companies Act, 2013 and Listing Regulations, the Board has carried out annual performance evaluation of its own performance, that of individual Directors as well as evaluation of its committees. The evaluation criteria, as defined in the Nomination and Remuneration Policy of the Company, covered various aspects of Board such as composition, performance of specific duties, obligations and governance.

The performance of individual directors was evaluated on parameters, such as, number of meetings attended, contribution made in the discussions, contribution towards formulation of the growth strategy of the Company, independence of judgement, safeguarding the interest of the Company and minority shareholders, additional time devoted besides attending Board / Committee meetings. The Directors have expressed their satisfaction with the evaluation process.

APPRECIATION

Your Directors wish to take the opportunity to express their sincere appreciation to our customers, suppliers, shareholders, employees, the Central, Uttar Pradesh and Karnataka Governments, financial institutions, banks and all other stakeholders for their whole-hearted support and co-operation.

We look forward to their continued support and encouragement.

For and on behalf of the Board of Directors

Dhruv M. Sawhney

Chairman and Managing Director

DIN: 00102999

June 29, 2021

Annexure-A

STATEMENT CONTAINING SALIENT FEATURES OF THE FINANCIAL STATEMENT OF SUBSIDIARIES OR ASSOCIATE COMPANIES OR JOINT-VENTURES

Part A : Subsidiaries

₹ in Lakhs

Name of the subsidiary	Triveni Energy Systems Ltd.	Triveni Engineering Ltd.	Triveni Entertainment Ltd.	Triveni Sugar Ltd.	Savistda Projects Ltd.	Triveni Industries Limited	Mathura Wastewater Management Pvt Ltd.	Triveni Foundation*	Gaurangi Enterprises Ltd.	United Shippers & Dredgers Ltd.
	(TESL)	(TEL)	(TENL)	(TSL)	(SPL)	(TIL)	(MWMPL)	(TF)	(GEL)	(USD)
	Wholly Owned Subsidiary	Wholly Owned Subsidiary	Wholly Owned Subsidiary	Wholly Owned Subsidiary	Wholly Owned Subsidiary	Wholly Owned Subsidiary	Wholly Owned Subsidiary	Wholly Owned Subsidiary	Wholly Owned Subsidiary	Wholly Owned Subsidiary
Date of becoming subsidiary/acquisition	15.02.2008	27.06.2006	20.03.2014	19.03.2014	19.03.2014	22.07.2015	12.06.2018	28.06.2020**	02.07.2020**	25.03.2021
1. Reporting period for the subsidiary concerned, if different from the holding company's reporting period	NA	NA	NA	NA	NA	NA	NA	28.06.2020 to 31.03.2021	02.07.2020 to 31.03.2021	25.03.2021 to 31.03.2021
2. Reporting currency and Exchange rate as on the last date of the relevant Financial year in the case of foreign subsidiaries	NA	NA	NA	NA	NA	NA	NA	NA	NA	NA
3. Share capital	385.00	265.00	417.00	205.00	455.00	200.50	1350.30	1.00	200.00	40.00
4. Other Equity	-12.41	115.14	-24.45	-10.38	-12.37	-10.82	1364.11	-0.44	-3.72	-85.35
5. Total assets	372.73	438.88	392.69	194.74	442.80	189.79	15641.74	0.68	196.45	0.64
6. Total Liabilities	0.14	58.75	0.15	0.12	0.17	0.12	12927.33	0.12	0.17	45.99
7. Investments	369.28	435.94	383.37	183.87	423.97	186.29	-	-	176.19	0.63
8. Turnover	-	-	-	-	-	-	9263.81	-	-	-
9. Profit before taxation	-0.93	-5.05	-1.46	-1.05	-0.86	-1.22	818.79	-0.44	-3.67	-0.17
10. Provision for taxation	0.02	0.02	0.00	0.00	0.06	0.00	209.83	0.00	0.05	0.00
11. Profit after taxation	-0.95	-5.07	-1.46	-1.05	-0.92	-1.22	608.96	-0.44	-3.72	-0.17
12. Proposed Dividend	-	-	-	-	-	-	-	-	-	-
13. Extent of shareholding (in %age)	100.00%	100.00%	100.00%	100.00%	100.00%	100.00%	100.00%	100.00%	100.00%	100.00%

* TF is a company incorporated under Section 8 of the Companies Act, 2013, and hence, its results are not considered in the Consolidated results of the Company.

** Date of incorporation

Note: Except MWMPL, all the remaining subsidiaries are relatively much smaller and no material business activities are being carried out in these companies

Part B: Associates and Joint Ventures

Name of Associates or Joint Ventures	Triveni Turbine Ltd.	Aqwise-Wise Water Technologies Ltd.
1. Latest audited Balance Sheet Date	31-Mar-21	31-Dec-20
2. Date on which the Associate or Joint Venture was acquired	01.10.2010	30.07.2012
3. Shares of Associate or Joint Ventures held by the company on the year end		
- No of shares	70627980	13008
- Amount of Investment in Associates/Joint Venture (₹ Lakhs)	706.35	3006.19*
- Extent of Holding%	21.85	25.04
4. Description of how there is significant influence	Due to equity stake being more than 20%	Due to equity stake being more than 20%
5. Reason why the associate/joint venture is not consolidated	Being consolidated	Being consolidated
6. Networth attributable to Shareholding as per latest audited Balance Sheet (₹ Lakhs)	13928.24	(1777.66)
7. Profit or Loss for the year (after tax) (₹ Lakhs) – as per Associate's financial statements considered for consolidated financial statements	10246.27	(7532.98)
i. Considered in Consolidation (₹ Lakhs)	2228.85	(2107.81)
ii. Not Considered in Consolidation	--	--

*The Company has entered into a share purchase agreement (SPA) on 25.03.2021 with an Israel based company (Buyer), pursuant to which, upon completion of necessary formalities, the entire equity stake held by the Company (including equity shares to be issued against conversion of loan of ₹ 302.01 Lakhs along with accrued interest) shall be sold to the Buyer. Accordingly, such investment in the associate company has been classified as Assets held for sale in the consolidated financial statements as on 31.03.2021 at its carrying value since the estimated consideration receivable is higher.

For and on behalf of the Board of Directors

Dhruv M. Sawhney
Chairman and Managing Director
DIN: 00102999

Homai A. Daruwalla
Director & Chairperson-Audit Committee
DIN: 00365880

Suresh Taneja
Group CFO

Geeta Bhalla
Group Vice President &
Company Secretary

June 29, 2021

Annexure-B

Corporate Governance Report

COMPANY'S PHILOSOPHY ON CODE OF GOVERNANCE

Your Company is of the belief that sound Corporate Governance is vital to enhance and retain stakeholder trust. Good Governance underpins the success and integrity of the organisation, institutions and markets. It is one of the essential pillars for building an efficient and sustainable environment, systems and practices to ensure that the affairs of the Company are being managed in a way which ensure accountability, transparency, fairness in all its transactions in the widest sense and meeting its stakeholder's aspirations and societal expectations. Your Company is committed to adopt the best governance practices and their adherence in the true spirit at all times. It envisages the attainment of a high level of transparency and accountability in the functioning of the Company and in the way it conducts business internally and externally.

In line with the above philosophy, your Company continuously strives for excellence through adoption of best governance and disclosure practices. The Company recognises that good governance is a continuing exercise and thus reiterates its commitment to pursue highest standard of Corporate Governance in the overall interest of its stakeholders.

Your Company has been consistently working for the betterment of the governance system executed with the Stock Exchanges. We are committed to doing things in the right way which includes but not limited to compliance with its applicable legal requirement.

THE HIGHLIGHT OF THE CORPORATE GOVERNANCE SYSTEM INCLUDES:

1. The Board of Directors of the Company is well represented with Executive, Non-Executive and Independent Non-Executive Directors with the Executive Chairman and Managing Director. As on the date of this report, the Independent Non-Executive Directors form about 62% of the Board of Directors.
2. The Board has constituted several Committees viz. Audit Committee, Nomination and Remuneration Committee, Stakeholders Relationship Committee, Corporate Social Responsibility Committee, Risk Management Committee and Executive Sub-Committee for more focused attention. The Board is empowered to constitute additional functional Committees from time to time, depending on the business needs.

3. The Company has established a Code of Conduct for Directors and Senior Management of the Company.
4. Whistle Blower Policy wherein the Employees and Directors may have the direct access to the Chairperson of the Audit Committee.
5. Risk Management framework to identify the risk for its businesses, to assess the probability of its occurrence and its mitigation plans. The information about the framework is placed before the Audit Committee and the Board periodically.

BOARD OF DIRECTORS

The Company is managed and guided by the Board of Directors ("Board"). The Board formulates the strategy, regularly reviews the performance of the Company and determines the purpose and values of the Company. The Board provides and evaluates the strategic direction of the Company, management policies and their effectiveness and ensures that the long-term interests of the shareholders are being served. The Chairman and Managing Director with the support of the Vice Chairman and Managing Director and senior executives oversees the functional matters of the Company.

As on the date of this report, the Board comprises of eight (8) Directors - 5 (five) Non-Executive and Independent Directors including 1 (one) Women Director, 1(one) Non Executive Non-Independent Director and 2 (two) Executive Directors. All the members of the Board are eminent persons with professional expertise and valuable experience in their respective areas of specialisation and bring a wide range of skills and experience to the Board.

None of the Directors on the Board is a Member on more than 10 Committees, and Chairperson of more than 5 Committees across all listed companies in which he is a Director. Necessary disclosures regarding Committee positions have been made by the Directors.

Meetings of the Board

The Board of Directors met seven times during the FY 21 ended on March 31, 2021. The interval between any two successive meetings did not exceed one hundred and twenty days. Board Meetings were held on April 25, 2020, June 17, 2020, August 10, 2020, September 16, 2020, November 9, 2020, February 3, 2021 and March 24, 2021.

Independent Directors

All the Independent Directors have confirmed that they meet the criteria as stipulated under Regulation 16(1)(b) of the Securities and Exchange Board of India (Listing Obligations and Disclosure Requirements) Regulations, 2015 ('Listing Regulations') read with Section 149(6) of the Companies Act, 2013 ('Act'). All such declarations were placed before the Board. Based on that, in the opinion of the Board, they fulfill the conditions of independence as specified in the Listing Regulations and the Act and are independent of the management. The maximum tenure of independent directors is in compliance with the Companies Act, 2013 and the terms and conditions of their appointment have been disclosed on the website of the Company.

Regulation 25(3) of Listing Regulations read with Schedule IV of the Companies Act, 2013 and the rules under it mandate that the Independent Directors of the Company hold at least one meeting in a year without the attendance of Non-Independent Directors of the Company and members of the management. During the year, separate meeting of the Independent Directors was held on March 24, 2021 without the attendance of non-independent directors and members of the management. The independent directors, inter-alia reviewed the performance of non-independent directors, Chairman of the Company and the Board as a whole.

FAMILIARISATION PROGRAMME FOR INDEPENDENT DIRECTORS

All the Directors including Independent Directors are provided with the necessary documents / brochures, reports and internal policies, codes of conduct to enable them to familiarise with the Company's procedure and practices. Directors are regularly updated on performance of each line of business of the Company, business strategy going forward and new initiatives being taken / proposed to be taken by the Company

through presentation. Factory visits are organised, as and when required, for the Directors. The details of the familiarisation programme of the Independent Directors are available on the Company's website at <http://www.trivenigroup.com/investor/corporate-governance/policies.html>

SUCCESSION PLANNING FOR THE BOARD AND SENIOR MANAGEMENT

Board of Directors

The Nomination and Remuneration Committee (NRC) of the Board shall identify the suitable person for appointment at Board level including from the existing top management. The NRC shall apply due diligence process to determine competency of person(s) being considered for appointment or re-appointment as a Director including Managing Director / Whole-time Director of the Company in accordance with the provisions of the Nomination and Remuneration Policy of the Company and the applicable provisions of the Companies Act, 2013 and the Rules made thereunder and the SEBI (LODR) Regulations, 2015, as amended from time to time.

Senior Management

The Managing Director(s) / Executive Director (s) are empowered to identify, appoint and remove the Senior Management Personnel in accordance with the provisions of the NRC Policy, and keeping in view the organization's mission, vision, values, goals and objectives and also to evaluate their performance considering the competencies/ indicators provided in the NRC Policy.

COMPOSITION OF THE BOARD

The composition of the Board of Directors, their attendance at Board Meetings held during the year and at the last Annual General Meeting (AGM) as also the details of Directorships and Committee positions held by them in other companies are given below:-

Name of the Director	Category	No. of Board Meetings		Attendance at last AGM held on September 28, 2020	No. of other Directorships* ²	No. of Committees positions held in other companies* ³	
		Held	Attended			Chairman	Member
Mr. Dhruv M. Sawhney* ¹ Chairman and Managing Director DIN- 00102999	Promoter & Executive Director	7	7	Yes	3	1	1
Mr. Tarun Sawhney* ¹ Vice Chairman and Managing Director DIN- 00382878	Promoter & Executive Director	7	7	Yes	3	None	1
Mr. Nikhil Sawhney* ¹ DIN- 00029028	Promoter & Non-Executive Director	7	7	Yes	3	None	3
Mr. Shekhar Datta DIN- 00045591	Independent Non-Executive Director	7	7	Yes	1	None	None

Name of the Director	Category	No. of Board Meetings		Attendance at last AGM held on September 28, 2020	No. of other Directorships* ²	No. of Committees positions held in other companies* ³	
		Held	Attended			Chairman	Member
Mr. Homai A. Daruwalla DIN- 00365880	Independent Non-Executive Director	7	7	Yes	8	3	9
Mr. Santosh Pande DIN- 01070414	Independent Non-Executive Director	7	7	Yes	2	None	2
Mr. Sudipto Sarkar DIN- 00048279	Independent Non-Executive Director	7	6	No	3	1	5
Mr. J.K. Dadoo DIN- 02481702	Independent Non-Executive Director	7	7	No	None	None	None

Mr Shekhar Datta resigned from the Board w.e.f. June 29, 2021 due to advancing age and health condition and there was no other material reason for his resignation. Mr Ajay Kumar Relan (DIN:00002632) has been appointed as an Additional Director in the capacity of Independent Director by the Board w.e.f. June 29, 2021, subject to approval of the shareholders.

*1 Mr. Tarun Sawhney and Mr. Nikhil Sawhney are sons of Mr. Dhruv M. Sawhney, Chairman & Managing Director of the Company and are thus related.

*2 Excludes Directorships in Indian Private Limited Companies, Foreign Companies, Firms, Partnerships including LLPs, Section 8 Companies and membership of various Chambers and other non-corporate organisations.

*3 The committees considered for the purpose are those prescribed under Regulation 26(1) of Listing Regulations i.e. Audit Committee and Stakeholders' Relationship Committee of public limited companies, whether listed or not. Further, number of Committee membership includes Committee Chairmanships.

Further, the details of directorship held by the Directors of the Company in other listed entities as on the date of this report are as follows:-

Name of Director	Name of other listed entity	Category of Directorship
Mr. Dhruv M. Sawhney	Triveni Turbine Limited	Promoter & Executive Director
Mr. Tarun Sawhney	Triveni Turbine Limited	Promoter & Non-Executive Director
Mr. Nikhil Sawhney	Triveni Turbine Limited	Promoter & Executive Director
Mr. Shekhar Datta	None	Not Applicable
Ms. Homai A. Daruwalla	Gammon Infrastructure Projects Limited	Independent Director
	Triveni Turbine Limited	Independent Director
	Jaiprakash Associates Limited	Independent Director
	Rolta India Limited	Independent Director
	Associated Alcohols & Breweries Ltd.	Independent Director
Dr. Santosh Pande	Triveni Turbine Limited	Independent Director
Mr. Sudipto Sarkar	Vesuvius India Limited	Independent Director
	EIH Associated Hotels Limited	Independent Director
	EIH Limited	Independent Director
Mr. J.K. Dadoo	None	Not Applicable
Mr. Ajay Kumar Relan	HT Media Ltd.	Independent Director
	Hindustan Media Ventures Ltd.,	Independent Director
	Next Media Works Ltd.,	Independent Director
	Digicontent Ltd.	Independent Director
	Capri Global Capital Ltd	Non-Independent Director

BOARD FUNCTIONING AND PROCEDURE

Matrix of skills/ expertise/ competence of the Board of Directors

The Board comprises qualified members who bring in the required skills, competence and expertise that allow them to make effective contribution to the Board and its committees.

Details of the core skills/ expertise/ competencies identified by the board of directors as required in the context of the Company's business(es) and sector(s) in which it operates to function effectively:

General management and leadership experience*: This includes experience in the areas of general management practices and processes, business development, strategic planning, global business opportunities, manufacturing, engineering, financial management, information technology, research and development, senior level experience and academic administration.

Knowledge, Functional and managerial experience*: Knowledge and skills in accounting and finance, business judgment, crisis response and management, industry knowledge, formulating policies and processes, legal & administration, sales and marketing, supply

chain, risk management & internal controls, financial & operational controls.

Diversity & Behavioural and Personal attributes: Diversity of thought, experience, perspective, gender and culture brought to the Board by individual members. Personal characteristics matching the Company's values, such as ethics & integrity, accountability, commitment, building relationship.

Corporate governance and Finance: Understanding of good corporate governance practices & regulatory framework applicable to the Company and its compliances, maintaining board and management accountability, protecting stakeholders' interests and Company's responsibilities towards customers, employees, suppliers, regulatory bodies and the communities in which it operates, financial skills, oversight for risk management and internal controls and proficiency in financial management.

*These skills/competencies are broad-based, encompassing several areas of expertise/ experience. Each Director may possess varied combinations of skills/experience within the described set of parameters, and it is not necessary that all Directors possess all skills/experience listed therein.

Given below is a list of core skills, expertise and competencies of the individual Directors:

Core Skills/Expertise	DMS	TS	NS	SD	HD	SP	SS	JKD	AKR
General Management and Leadership	✓	✓	✓	✓	✓	✓	✓	✓	✓
Functional and managerial experience	✓	✓	✓	✓	✓	✓	✓	✓	✓
Diversity behavioural and personal attributes	✓	✓	✓	✓	✓	✓	✓	✓	✓
Corporate governance and Finance	✓	✓	✓	✓	✓	✓	✓	✓	✓

DMS- Mr. Dhruv M. Sawhney, TS- Mr. Tarun Sawhney, NS- Mr. Nikhil Sawhney, SD – Mr. Shekhar Datta, HD – Ms Homai Daruwalla, SP – Dr Santosh Pande, SS- Mr. Sudipto Sarkar, JKD – Mr J.K. Dadoo, AKR – Mr Ajay Kumar Relan

BOARD MEETING FREQUENCY AND CIRCULATION OF AGENDA PAPERS

The Board and its Committees meet at regular intervals for discussion on agenda circulated well in advance by the Company. All material information is incorporated in the agenda for facilitating meaningful and focused discussion at the meeting. Where it is not practical to attach or send the relevant information as a part of agenda papers, the same are tabled at the Meeting. To meet business exigencies, resolutions in respect of urgent matters are passed by the Directors by Circulation.

The Company has proper systems to enable the Board to periodically review compliance reports of all laws applicable to the Company, as prepared by the Company as well as

steps taken by the Company to rectify instances of non-compliances. The Board reviewed compliance reports prepared by the Company on quarterly periodicity.

Presentation by the Management

The senior management of the Company is invited at the meetings to make presentations to the Board, covering operations of the businesses of the Company, Strategy and Business Plans and to provide clarifications as and when necessary.

Access to Employees

The Directors bring an independent perspective on the issues deliberated by the Board. They have complete and unfettered access to any information of the Company and to any employee of the Company.

Availability of Information to Board Member includes:

- Performance of each line of business, business strategy going forward, new initiatives being taken / proposed to be taken and business plans of the Company.
- Annual operating plans and budgets including capital expenditure budgets and any updates.
- Quarterly results of the Company including results of the business segments.
- Minutes of the meetings of Committees of the Board.
- The information on recruitment and remuneration of senior officers just below the Board level, including appointment or removal of Chief Financial Officer and the Company Secretary.
- Show cause, demand, prosecution notices and penalty notices which are materially important.
- Fatal or serious accidents, dangerous occurrences, any material effluent or pollution problems.
- Any material default in the financial obligations to and by the Company, or substantial non-payment for goods sold / services provided by the Company.
- Any issue, which involves possible public or product liability claims of substantial nature, including any judgment or order which, may have passed strictures on the conduct of the Company or taken an adverse view regarding another enterprise that can have negative implications on the Company.
- Details of any joint venture or collaboration agreement.
- Transactions that involve substantial payment towards goodwill, brand equity, or intellectual property.
- Significant labour problems and their proposed solutions. Any significant development in Human Resources / Industrial Relations front like signing of wage agreement, implementation of Voluntary Retirement Scheme etc.
- Sale of material nature, of investments, subsidiaries, assets, which is not in normal course of business.
- Quarterly details of foreign exchange exposures and the steps taken by the management to limit the risks of adverse exchange rate movement, if material.
- Non-compliance of any regulatory, statutory nature or listing requirements and shareholders servicing issues, such as non-payment of dividend, delay in share transfer etc.
- Statutory compliance report of all laws applicable to the Company.

- Details of the transactions with the related parties.
- General notices of interest of directors.
- Appointment, remuneration and resignation of Directors.

Post Meeting follow up Mechanism

The important decisions taken at the Board / Committee meetings are promptly communicated to the respective units/ departments. Action taken report on the decisions of the previous meeting(s) is placed at the immediately succeeding meeting of the Board/ Committee for information and review by the Board.

Appointment/Re-appointment of Director

The information / details pertaining to Directors seeking appointment/re-appointment in ensuing Annual General Meeting (AGM), is provided in the Notice for the AGM. The Notice contains the relevant information, like brief resume of the Directors, nature of their expertise in specific functional areas and names of the companies in which they hold Directorship and membership of any Committee of the Board.

BOARD COMMITTEES

The Board of Directors have constituted following Committees consisting of Executive and Non-Executive Directors of the Company with adequate delegation of powers to meet various mandatory requirements of the Act and Listing Regulations and perform as also to oversee business of the Company and to take decisions within the parameters defined by the Board. The Company Secretary acts as the Secretary to all the Committees of the Board:

1. Audit Committee
2. Nomination and Remuneration Committee
3. Stakeholders' Relationship Committee
4. Corporate Social Responsibility Committee
5. Risk Management Committee

Details on the role and composition of these committees, including the number of meetings held during the financial year and the related attendance are provided below:

(I) Audit Committee

Composition, Meetings & Attendance

The Committee is headed by an Independent Director and consists of the members as stated below. During the year ended on March 31, 2021, the Audit Committee met six times i.e. on June 16, 2020, August 10, 2020, September 3, 2020, September 16, 2020, November 9, 2020 and February 3, 2021. The composition and attendance of each Audit Committee Member is as under:-

Name of the Member	Category	No. of Meetings	
		Held	Attended
Ms. Homai A. Daruwalla – Chairperson	Independent Non-Executive Director	6	6
Mr. Tarun Sawhney	Promoter & Executive Director	6	6
Mr. Shekhar Datta*	Independent Non-Executive Director	6	6
Mr. Sudipto Sarkar	Independent Non-Executive Director	6	6

*ceased to be a member w.e.f. June 29, 2021

The Chairperson of the Audit Committee attended the last AGM held on September 28, 2020 to answer the shareholders' queries.

Terms of reference

The function and terms of reference of Audit Committee broadly include:-

- Reviewing the Company's financial reporting process and its financial statements.
- Reviewing the accounting and financial policies and practices and compliance with applicable accounting standards.
- Reviewing the efficacy of the internal control mechanism, monitor risk management policies adopted by the Company and ensure compliance with regulatory guidelines.
- Reviewing reports furnished by the internal and statutory auditors, and ensure that suitable follow-up action is taken.
- Examining accountancy and disclosure aspects of all significant transactions.
- Reviewing with management the quarterly, half yearly & annual financial statements including review of qualifications, if any, in the audit report before submission to the Board for approval.
- Recommending appointment of external and internal auditors and fixation of audit fees.
- Seeking legal or professional advice, if required.
- Approval or any subsequent modifications of transactions of the Company with related parties.
- Scrutiny of Inter-Corporate loans and investments.
- Valuation of undertakings or assets of the Company, wherever required.

- Reviewing the utilization of loans and/or advances from/investment by the holding company in the subsidiary exceeding Rupees 100 crore or 10% of the asset size of the subsidiary, whichever is lower including existing loans / advances / investment.

The constitution and terms of reference of the Audit Committee meet the requirements of Regulation 18 of the Listing Regulations read with the relevant provisions of the Companies Act, 2013.

(II) Nomination and Remuneration Committee (NRC)

Composition, Meetings & Attendance

The NRC is headed by an Independent Director and consists of the members as stated below. During the FY 21 ended on March 31, 2021 the NRC met once i.e. on June 16, 2020. The composition and attendance of each Audit Committee Member is as under:-

Name of the Member	Category	No. of Meetings	
		Held	Attended
Dr. Santosh Pande – Chairman	Independent Non-Executive Director	1	1
Mr. Nikhil Sawhney	Promoter & Non-Executive Director	1	1
Mr. Shekhar Datta	Independent Non-Executive Director	1	1
Mr. Sudipto Sarkar	Independent Non-Executive Director	N.A.	N.A.

Mr Shekhar Datta ceased to be a member of NRC due to his resignation from the Board w.e.f. June 29, 2021, which necessitated re-constitution of NRC by induction of Mr Sudipto Sarkar as a member w.e.f. June 29, 2021.

Terms of reference

The function and terms of reference of NRC broadly include:

- To identify persons who are qualified to become Directors (Executive, Non-Executive and Independent Directors) and who may be appointed in senior management in accordance with the criteria laid down.
- To recommend to the Board their appointment and removal and shall carry out evaluation of every director's performance.
- To formulate the criteria for determining qualifications, positive attributes and independence of a director and recommend to the Board a policy, relating to the remuneration for the directors (Executive, Non-Executive and Independent Directors), key managerial personnel and other employees.

- Plan for succession of Board members and Key Managerial Personnel.
- Devising a policy on Board diversity.
- To formulate, administer and supervise the Company's Employee Stock Option Schemes (ESOP Schemes) including grant of stock options under the ESOP Schemes to the permanent employees of the Company from time to time in accordance with SEBI Guidelines/Regulations.
- To review the adequacy of aforesaid terms of reference and recommend any proposed change to the Board for its approval.

The constitution and terms of reference of the NRC meet the requirements of Regulation 19 of the Listing Regulations read with the relevant provisions of the Companies Act, 2013 and the SEBI ESOP Guidelines/Regulations.

Remuneration Policy

In terms of the provisions of the Companies Act, 2013 and the Listing Regulations, the Board of Directors of the Company has adopted Nomination and Remuneration Policy for nomination and remuneration of Directors, Key Managerial Personnel (KMP) and Senior Management. The Nomination and Remuneration Committee inter-alia recommends the remuneration of Executive Directors, which is approved by the Board of Directors, subject to approval of the shareholders, wherever necessary. The Chairman and Managing Director evaluates the Senior Management Personnel, including KMPs considering the competencies/indicators provided in the Remuneration Policy. The Nomination and Remuneration Policy is available on the Company's website at <http://www.trivenigroup.com/investor/corporate-governance/policies.html>

Performance Evaluation and Criteria

The Nomination and Remuneration Committee has laid down the criteria for evaluation of performance of Directors based on the indicators provided in the Remuneration Policy. A structured questionnaire was prepared for capturing various aspects of the functioning of Board, such as adequacy of the composition of the Board and its Committees, Board culture, execution and performance of specific duties, obligations and governance. The performance evaluation of Independent Directors (IDs) was done by the entire Board of Directors, excluding the ID being evaluated, based on parameters, such as, number of meetings attended, inputs and

contribution made, independence of judgement, independence from management, effectiveness etc. The performance evaluation of the Board, its Chairman and the Non-Independent Directors was carried out by the Independent Directors. The Board expressed its satisfaction with the evaluation process.

Remuneration to Executive Directors

The remuneration to the Executive Directors is recommended by the Nomination and Remuneration Committee to the Board and after approval by the Board, the same is put up for the Shareholders approval. Executive Directors do not receive any sitting fees for attending the Board and Committee meetings.

During the FY 21 ended on March 31, 2021, the Company had two Executive Directors viz. Mr. Dhruv M Sawhney, Chairman and Managing Director (CMD) and Mr. Tarun Sawhney, Vice Chairman and Managing Director (VCMD).

The details of remuneration paid/payable to CMD and VCMD during the FY 21 ended on March 31, 2021 are as under:

₹ in Lakhs

Name of the Executive Director	Mr. Dhruv M. Sawhney	Mr. Tarun Sawhney
	CMD	VCMD
No. of Equity Shares held	37733691	13820236
Service Period	31.03.2020*1 to 30.03.2025	01.10.2018*1 to 30.09.2023
Salary	Nil	320.74
Performance Bonus/Commission	Nil	250.00
Contribution to PF & other funds*2	Nil	51.19
Other Perquisites	Nil	28.46
Total	Nil	650.39

*1 date of re-appointment. There is no notice period and no severance fees.

*2 does not include gratuity as it is provided based on actuarial valuation.

During the year, Mr Dhruv M. Sawhney has not drawn any remuneration from this Company in his capacity as Chairman and Managing Director of the Company. He has drawn remuneration from Triveni Turbines DMCC, Dubai (UAE), a foreign step-down subsidiary

of an Associate Company, Triveni Turbine Ltd. (TTL). The remuneration drawn by Mr Tarun Sawhney is within the ceiling prescribed under the Companies Act, 2013, Listing Regulations and in accordance with the approval of the Board and the Shareholders of the Company.

Remuneration to Non-Executive Directors (NEDs)

The Company pays sitting fee to its NEDs for attending the meetings of the Board and its Committees within the limits prescribed under the provisions of the Companies Act, 2013. In addition to the sitting fees, the NEDs are entitled to profit based commission within the limits approved by the shareholders of the Company. The said commission is decided by the Board and distributed to NEDs based on their performance.

The details of the remuneration paid/provided during the FY21 ended on March 31, 2021 to NEDs are as follows:-

₹ in Lakhs

Name of the Non-Executive Director	Sitting Fees	Commission	No. of Equity Shares held
Mr. Shekhar Datta*	14.75	10.00	10000
Mr. Nikhil Sawhney	9.60	45.00	14367837
Ms. Homai A. Daruwalla	15.00	11.00	Nil
Dr. Santosh Pande	10.60	10.00	Nil
Mr. Sudipto Sarkar	12.00	10.00	Nil
Mr. J.K. Dadoo	8.00	10.00	Nil

*ceased to be a director w.e.f. June 29, 2021

None of the Independent / Non-Executive Directors have any pecuniary relationship or transactions with the Company, its promoters and its senior management, its subsidiaries and associate companies except for the payment of remuneration as stated above. Dr. Santosh Pande, and Ms Homai A. Daruwalla, Independent Directors have received sitting fee / commission as Director and Member of Board/Committees of Triveni Turbine Ltd. (Associate Company), whereas Mr. Nikhil Sawhney, Promoter & Non-Executive Director is the Vice Chairman and Managing Director of the said Associate Company and has drawn remuneration from that Company.

During the year, the Company has not issued any Stock Option to the Directors including Independent Directors under its ESOP Schemes.

(III) Stakeholders' Relationship Committee (SRC) Composition, Meetings & Attendance

The Committee is headed by an Independent Director and consists of the members as stated below. During

the FY 21 ended on March 31, 2021 the Committee met once i.e. on March 24, 2021. The composition and attendance of each Committee Member is as under:-

Name of the Member	Category	No. of Meetings	
		Held	Attended
Dr. Santosh Pande – Chairman	Independent Non-Executive Director	1	1
Mr. Tarun Sawhney	Promoter & Executive Director	1	1
Mr. Nikhil Sawhney	Promoter & Non-Executive Director	1	1
Mr. Sudipto Sarkar	Independent Non-Executive Director	1	-

Terms of reference

The function and terms of reference/role of SRC broadly include:-

- Resolving the grievances of the security holders of the listed entity including complaints related to transfer/transmission of shares, non-receipt of annual report, non-receipt of declared dividends, issue of new/duplicate certificates, general meetings etc.
- Review of measures taken for effective exercise of voting rights by shareholders.
- Review of adherence to the service standards adopted by the company in respect of various services being rendered by the Registrar & Share Transfer Agent.
- Review of the various measures and initiatives taken by the Company for reducing the quantum of unclaimed dividends and ensuring timely receipt of dividend warrants/annual reports/statutory notices by the shareholders of the Company.
- Review of the report(s) which may be submitted by the Company Secretary/RTA relating to approval/confirmation of requests for share transfer/transmission/transposition/consolidation/issue of duplicate share certificates/sub-division, consolidation, remat, demat etc on quarterly basis.

The constitution and terms of reference of the Stakeholders' Relationship Committee meet the requirements of Regulation 20 of the Listing Regulations read with the relevant provisions of the Companies Act, 2013. Ms. Geeta Bhalla, Group Vice President & Company Secretary has been designated as the Compliance Officer of the Company.

Details of investor complaints

During the FY 21 ended on March 31, 2021, the Company received complaints from various shareholders/investors directly and/or through the Stock Exchanges/SEBI relating to non-receipt of dividend / redemption money, annual report/notice of general meeting, new share certificates etc. All of them were resolved/replied suitably by furnishing the requisite information/documents. Details of investor complaints received and resolved during the FY 21 are as follows:

Opening Balance	Received	Resolved	Pending
Nil	5	5	Nil

Further, there were no pending share transfers and requests for dematerialization as on March 31, 2021.

(IV) Corporate Social Responsibility Committee (CSR Committee)

Composition, Meetings & Attendance

The Committee is headed by an Independent Director and consists of the members as stated below. During the FY 21 ended on March 31, 2021 the Committee met twice i.e. on June 16, 2020 and Sept 16, 2020. The composition and attendance of each Committee Member is as under:-

Name of the Member	Category	No. of Meetings	
		Held	Attended
Ms. Homai A. Daruwalla - Chairperson	Independent Non-Executive Director	2	2
Dr. Santosh Pande	Independent Non-Executive Director	2	2
Mr. Tarun Sawhney	Promoter & Executive Director	2	2
Mr. Nikhil Sawhney	Promoter & Non-Executive Director	2	2

Terms of reference

The CSR Committee is authorized to formulate and recommend to the Board, a CSR policy indicating the activity or activities to be undertaken by the Company as specified in Schedule VII of the Companies Act, 2013; recommend the amount to be spent on such activities; monitor the Company's CSR policy periodically and institute a transparent monitoring mechanism for the implementation of the CSR projects.

The constitution and terms of reference of the CSR Committee meet the requirements of relevant provisions of the Companies Act, 2013.

(V) Risk Management Committee (RMC)

In compliance with Regulation 21 of the Listing Regulations, the Board of Directors of the Company has constituted RMC effective from June 29, 2021. RMC is headed by an Executive Director and consists of four Board members (including an Independent Director) viz. Mr Dhruv M. Sawhney – Chairman, Mr Tarun Sawhney, Mr Nikhil Sawhney and Mr J.K. Dadoo.

Terms of reference

The role and powers of the RMC broadly include:

- To formulate a detailed risk management policy.
- To ensure that appropriate methodology, processes and systems are in place to monitor and evaluate risks associated with the business of the Company.
- To monitor and oversee implementation of the risk management policy, including evaluating the adequacy of risk management systems.
- To periodically review the risk management policy, at least once in two years, including by considering the changing industry dynamics and evolving complexity.
- To keep the board of directors informed about the nature and content of its discussions, recommendations and actions to be taken.
- To review the appointment, removal and terms of remuneration of the Chief Risk Officer of the Company (if any).
- To coordinate the activities of the Committee with other committees, in instances where there is any overlap with activities of other such committees, as per the framework laid down by the board of directors.
- To seek information from any employee, obtain outside legal or other professional advice and secure attendance of outsiders with relevant expertise, if it considers necessary.
- To pursue such other activities and functions as may be provided under the relevant provisions of the Companies Act, 2013 or SEBI (LODR) Regulations, 2015 duly amended from time to time.

The constitution and terms of reference of RMC meet the requirements of Regulation 21 of the Listing Regulations.

Other Committees

Executive Sub-Committee

Apart from the above statutory committees, the Board of Directors have constituted an Executive Sub-Committee comprising of four (4) Directors to oversee routine matters that are in the normal course of the business. The Board of Directors have delegated certain powers to this Committee to facilitate the working of the Company. The Committee met once during the FY21 ended on March 31, 2021.

GENERAL BODY MEETINGS

Particulars of the last three Annual General Meetings are as follows:

Year	Date & Day	Location	Time	Special Resolution
2019-20	September 28, 2020 Monday	Conducted AGM through Video conferencing/other audio Visual means*.	11:00 a.m.	1. Re-appointment of Mr. Dhruv M. Sawhney as Managing Director (designated Chairman & Managing Director) of the Company for a period of five years w.e.f. 31.3.2020 and payment of remuneration to him.
2018-19	September 27, 2019 Friday	Company's Guest House at Deoband Sugar Unit Complex Deoband, District Saharanpur, U.P.	12:30 p.m.	1. Re-appointment of Mr Sudipto Sarkar as an Independent Director for a period of five years w.e.f. 14.9.2019.
2017-18	September 28, 2018 Friday	Company's Guest House at Deoband Sugar Unit Complex Deoband, District Saharanpur, U.P.	12:30 p.m.	1. Re-appointment of Mr. Tarun Sawhney as Managing Director (designated as Vice Chairman & Managing Director) of the Company for a period of five years w.e.f. 1.10.2018 and payment of remuneration to him.

*Pursuant to the General Circular dated May 5, 2020 issued by the Ministry of Corporate Affairs.

POSTAL BALLOT

(a) Details of the Special Resolution passed by the Company through Postal Ballot:

During the FY 21 ended on March 31, 2021, the Company has not sought approval from its shareholders for passing of any special resolution through Postal Ballot.

(b) Whether any special resolution is proposed to be conducted through postal ballot:

There is no immediate proposal for passing any special resolution through postal ballot on or before ensuing Annual General Meeting.

(c) Procedure for Postal Ballot:

The Company endeavours to follow the procedure laid down under the relevant provisions of the Act read with rules thereof and the provisions of the Listing Regulations as and when there is any proposal for passing resolutions by postal ballot.

MEANS OF COMMUNICATION

(a) **Quarterly Results:** The Unaudited quarterly / half yearly financial results and the annual audited financial results of the Company were published

in National English and Hindi newspapers and displayed on the website of the Company at www.trivenigroup.com and the same were also sent to all the Stock Exchanges where the equity shares of the Company are listed. The Investor's brief were also sent to Stock Exchanges.

(b) **Website www.trivenigroup.com:** Detailed information on the Company's business and products; quarterly / half yearly / nine months and annual financial results, Investor brief and the quarterly distribution of Shareholding are displayed on the Company's website.

(c) **Teleconferences and Press conferences, Presentation etc.:** The Company held quarterly Investors Teleconferences and Press Conferences for the investors of the Company after the declaration of the Quarterly / Annual Results. The Company made presentations to institutional investors /analysts during the period which are available on the Company's website.

(d) **Exclusive email ID for investors:** The Company has designated the email id shares@trivenigroup.com exclusively for investor servicing, and the

same is prominently displayed on the Company's website www.trivenigroup.com. The Company strives to reply to the Complaints within a period of 6 working days.

- (e) **Annual Report:** Annual Report contains inter-alia Audited Annual Stand-alone Financial Statement, Consolidated Financial Statement, Directors' Report and Auditors' Report. The Management Perspective, Business Review and Financial Highlights are also part of the annual report.
- (f) **The Management Discussion & Analysis:** The Management Discussion & Analysis Report forms part of the annual report.
- (g) **Intimation to Stock Exchanges:** The Company intimates stock exchanges all price sensitive information or such other information which in its opinion are material & of relevance to the shareholders. The Company also submits electronically various compliance reports / statements periodically in accordance with the provisions of the Listing Regulations on NSE and BSE Electronic Filing System.

- (c) **Dividend Record Date:** September 10, 2021
- (d) **Dividend Payment Date:** Within 30 days of AGM
- (e) **Listing on Stock Exchanges**

The equity shares of the Company are listed at the following stock exchanges:

Sl. No.	Name and Address of Stock Exchanges	Stock Code
1.	BSE Ltd., Phiroze Jeejeebhoy Towers, Dalal Street, Fort, Mumbai - 400 023.	532356
2.	National Stock Exchange of India Ltd., Exchange Plaza, 5 th Floor, Plot No. C/1, G Block, Bandra (E), Mumbai - 400 051.	TRIVENI

The Company has paid the listing fees for the Financial Year 2021-22 to both the aforesaid Stock Exchanges.

GENERAL SHAREHOLDER INFORMATION

(a) Annual General Meeting

Day & Date : Friday, September 17, 2021

Time : 3:00 P.M. (IST)

Venue : The Company is conducting the meeting through Video Conferencing/ Other Audio Visual Means pursuant to the General Circular dated January 13, 2021 read with General Circular dated May 5, 2020 issued by the Ministry of Corporate Affairs.

(b) Financial Year : April to March

Financial calendar for the financial year 2021-22 (tentative)

Financial Reporting for the quarter ending June 30, 2021	By mid of August 2021
Financial Reporting for the quarter / half year ending September 30, 2021	By mid of November 2021
Financial Reporting for the quarter / nine months ending December 31, 2021	By mid of February 2022
Financial Reporting for the annual audited accounts for the financial year ending March, 31, 2022	By the end of May 2022

(f) Market Price Data/Stock Performance: FY21 ended on March 31, 2021

During the year under report, the trading in Company's equity shares was from April 1, 2020 to March 31, 2021. The high low price during this period on the BSE and NSE was as under:-

Month	Bombay Stock Exchange (BSE)		National Stock Exchange (NSE)	
	High	Low	High	Low
April, 2020	43.50	35.75	53.50	35.80
May, 2020	42.90	34.70	42.95	34.55
June, 2020	59.35	40.35	59.50	40.90
July, 2020	59.20	51.80	59.00	51.80
August, 2020	82.00	56.70	82.00	56.90
September, 2020	78.10	65.15	78.25	65.00
October, 2020	79.95	70.55	79.30	70.55
November, 2020	75.00	63.20	74.90	64.25
December, 2020	81.50	62.45	81.70	62.35
January, 2021	76.15	70.25	76.25	70.40
February, 2021	88.50	69.00	88.65	68.80
March, 2021	97.80	81.45	97.80	80.00

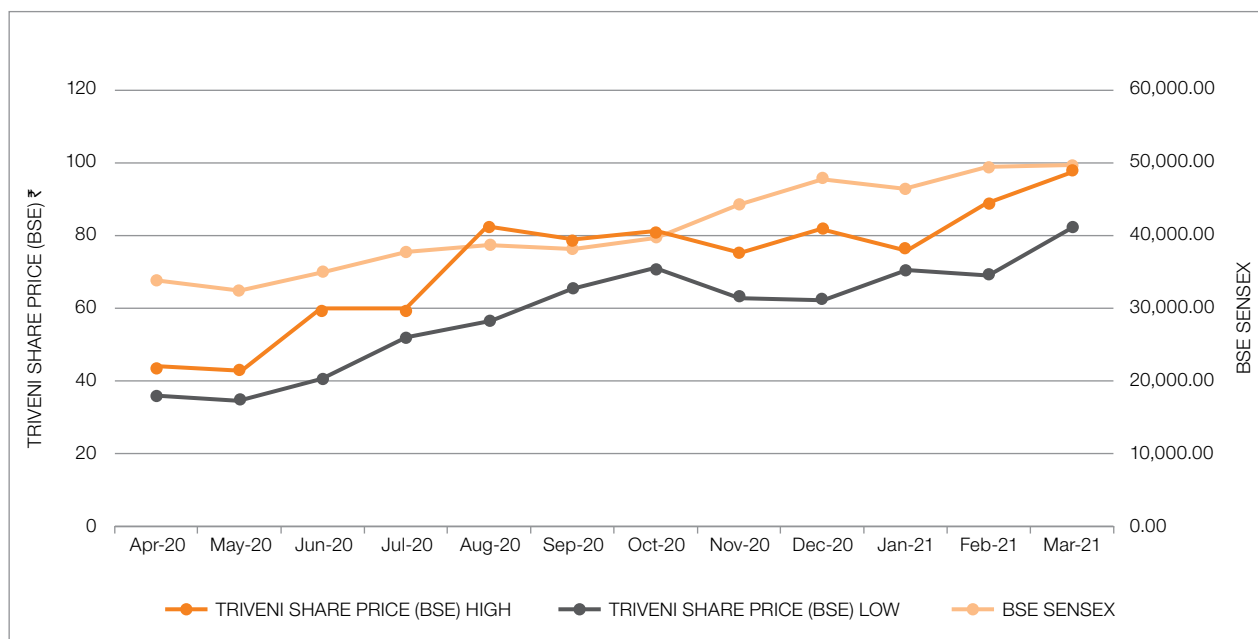
(g) Performance of the share price of the Company in comparison to the BSE Sensex

(h) Registrar & Share Transfer Agent

M/s KFin Technologies Pvt. Ltd.,
 (formerly M/s Karvy Fintech Pvt. Ltd.)
 Unit: Triveni Engineering & Industries Limited
 Selenium Tower B, Plot No.31-32, Gachibowli
 Financial District, Nanakramguda, Serilingampally Mandal,
 Hyderabad – 500 032
 Tel.:- Board No.: 040 6716 2222
 Fax No.: 040 23001153
 Email : einward.ris@kfintech.com

(i) Share Transfer System

The Company's share transfer authority has been delegated to the Company Secretary / Registrar and Transfer Agent M/s KFin Technologies Pvt. Ltd., which generally approves and confirms the request for share

transfer/ transmission / transposition / consolidation / issue of duplicate share certificates / sub-division, consolidation, remat, demat and perform other related activities in accordance with the Listing Regulations and SEBI (Depositories and Participants) Regulations, 1996 and submit a report in this regard to Stakeholders' Relationship Committee.

The shares sent for physical transfer are registered and returned within the stipulated period from the date of receipt of request, if the documents are complete in all respects. As per the requirement of regulation 40(9) of the Listing Regulations, a certificate on half yearly basis confirming due compliance of share transfer/transmission formalities by the Company from Practicing Company Secretary has been submitted to Stock Exchanges within stipulated time.

(j) Distribution of Equity Shareholding as on March 31, 2021

Group of Shares	Number of Shareholders	% of total Shareholders	Number of Shares held	% of Total Shares
From 1 - 500	43416	85.359	5357906	2.216
501 – 1000	3566	7.011	2844580	1.177
1001 - 2000	1766	3.472	2665707	1.103
2001 - 3000	560	1.101	1447216	0.599
3001 - 4000	270	0.531	964049	0.399
4001 - 5000	300	0.590	1424920	0.589
5001 - 10000	432	0.849	3263032	1.350
10001 & above	553	1.087	223787700	92.568
Total	50863	100.000	241755110	100.000

(k) Shareholding Pattern of Equity Shares as on March 31, 2021

Category	Number of Shares held	% of total Shareholders
Promoters	165439263	68.43
Mutual Funds	9625186	3.98
Banks/Financial Institutions/ Insurance Cos.	50	0.00
Foreign Portfolio Investors	6716286	2.78
Bodies Corporate/NBF	5938691	2.46
Indian Public(*)	49240746	20.37
NRIs / Foreign Nationals	4430638	1.83
Others – Clearing Members/ Trust/IEPF	364250	0.15
Total	241755110	100.00

(*) Includes 10,000 equity shares held by a director.

(l) Dematerialisation of Shares & Liquidity

The Company's equity shares are compulsorily traded in the electronic form. The Company has entered into an Agreement with NSDL and CDSL to establish electronic connectivity of its equity shares for scrip less trading. Both NSDL & CDSL have admitted the Company's equity share on their system.

The system for getting the shares dematerialised is as under:

- Share Certificate(s) along with Demat Request Form (DRF) will be submitted by the shareholder to the Depository Participant (DP) with whom he/she has opened a Depository Account.
- DP will process the DRF and generates a unique number DRN.
- DP will forward the DRF and share certificates to the Company's Registrar and Share Transfer Agent.
- The Company's Registrar and Share Transfer Agent after processing the DRF will confirm or reject the request to the Depositories.
- Upon confirmation, the Depository will give the credit to shareholder in his / her depository account maintained with DP.

As on March 31, 2021, 99.9% of total equity share capital of the Company was held in dematerialised form (including 100% of the promoter holding). The ISIN allotted by NSDL / CDSL is INE256C01024. Confirmation in respect of the requests for dematerialisation of shares is sent to NSDL and CDSL within the stipulated period.

(m) Outstanding GDR / ADR or Warrants

As on date there are no Global Depository Receipts (GDR), American Depository Receipt (ADR), Warrants or any other convertible instrument.

(n) Commodity price risk or foreign exchange risk and hedging activities

Barring sugarcane, the price of which is fixed by the Government, the Company is not exposed to any material commodity price risks in respect of other raw materials. In respect of its final products, the Company is exposed to sugar price risk and in view of sugar business being a dominant business of the Company, its impact is substantial. However, the Company does not have significant risks from foreign currency fluctuations as the foreign exposures are nominal. The details on these risks, mitigation and hedging potential thereof are stated in Note 41 of the Standalone Financial Statements

and in the Management Discussions & Analysis forming part of the Annual Report.

(o) Reconciliation of Share Capital Audit

As stipulated by SEBI, a qualified Practicing Company Secretary carries out Reconciliation of Share Capital Audit to reconcile the total admitted capital with NSDL and CDSL and the total issued and listed capital. This audit is carried out every quarter and the report thereon is submitted to the Stock Exchanges. The Audit confirms that the total listed and paid-up capital is in agreement with the aggregate of the total number of shares in dematerialised form and in physical form.

(p) Unclaimed Dividend

All unclaimed dividends upto the financial year 2011-12 (Final Dividend) have been transferred to the Investor Education and Protection Fund (IEPF), administered by the Central Government.

The dividends for the succeeding years remaining unclaimed for 7 years will be transferred by the Company to the said IEPF on the due dates as given hereunder:

Financial Year/ Period	Whether Interim/ Final	Date of declaration of Dividend	Due date for transfer to IEPF
2017-18	Interim Dividend	10.08.2017	10.09.2024
2018-19	Interim Dividend	13.02.2019	17.03.2026
2019-20	Interim Dividend	10.02.2020	15.03.2027

Shareholders who have not so far encashed their dividend warrant(s) or have not received the same are requested to seek issuance of duplicate warrant(s) by writing to the Company confirming non-encashment / non-receipt of dividend warrant(s).

(q) Transfer of Equity Shares to Investor Education and Protection Fund (IEPF)

In compliance with the requirements laid down in Section 124(6) of the Companies Act, 2013 read with the Investor Education and Protection Fund Authority (Accounting, Audit, Transfer and Refund) Rules, 2016, the Company has transferred equity shares of all such shareholders whose dividends had remained unpaid or unclaimed for seven consecutive years or more, to the Demat Account of IEPF. However, the shareholders are entitled to claim their equity shares including all the corporate benefits accruing on such shares, if any, from the IEPF Authority by submitting an online application in prescribed Form IEPF-5 and sending a physical copy of the said Form duly signed by all the joint shareholders, if any, as per the specimen signatures recorded with the Company along

with requisite documents enumerated in the Form IEPF-5, to the Company's Registrar & Transfer Agent, M/s KFin Technologies Pvt. Ltd., Hyderabad. The Rules and Form IEPF-5 for claiming back the equity shares are available on the website of IEPF www.iepf.gov.in. It may please be noted that no claim shall lie against the Company in respect of equity shares transferred to IEPF pursuant to the said Rules. The details of the shareholders whose equity shares had been transferred to the Demat Account of the IEPF and the details of unclaimed dividends lying with the Company as on the date of last AGM (i.e. Sept 28, 2020) are available on the website of the Company at www.trivenigroup.com/investor/shareholders-information. Further, shares in respect of which dividend will remain unclaimed progressively for seven consecutive years, will be reviewed for transfer to the IEPF as required by law. In the interest of shareholders, the Company send prior intimation to the concerned shareholders to claim their unclaimed dividends in order to avoid transfer of dividend/shares to IEPF and publish a notice to this effect in the newspapers.

Equity shares of the Company lying in IEPF suspense account

In accordance with the requirement of Regulation 34(3) and Part F of Schedule V to the SEBI (Listing Regulations, detail of the equity shares in the suspense account are as follows:

Particulars	Number of Shareholders	No of Equity shares
Aggregate number of shareholders and the outstanding shares in the suspense account lying at the beginning of the year	864	76888
Number of shareholders who approached listed entity for transfer of shares from suspense account during the year	3	1496
Number of shareholders to whom shares were transferred from suspense account during the year	3	3087
Aggregate number of shareholders and the outstanding shares in the suspense account lying at the end of the year	1025	100634

The voting rights on the shares outstanding in the said account as on March 31, 2021 shall remain frozen till the rightful owner of such shares claims the shares.

(r) Locations

Registered Office

Triveni Engineering & Industries Limited
 Deoband, Distt. Saharanpur
 Uttar Pradesh - 247 554
 Tel. :- 01336-222185, 222497
 Fax :- 01336-222220

Share Department

Triveni Engineering & Industries Ltd.
 8th Floor, Express Trade Towers,
 15-16, Sector 16A, Noida-201 301.
 Tel. :- 0120-4308000; Fax :- 0120-4311010-11
 email :- shares@trivenigroup.com

Plant Locations

Detailed information on plant / business locations is provided elsewhere in the Annual Report.

Address for correspondence

Please contact the Compliance Officer of the Company at the following address regarding any questions or concerns:

Ms. Geeta Bhalla
 Group Vice President & Company Secretary
 Triveni Engineering & Industries Ltd.
 8th Floor, Express Trade Towers,
 15-16, Sector 16A, Noida-201 301.
 Tel. :- 0120-4308000; Fax :- 0120-4311010-11
 Email :- shares@trivenigroup.com

(s) Credit Rating

During the financial year 2020-21, ICRA has, reaffirmed the rating for long term and short term facilities of the Company at AA- and A1+ respectively with stable outlook. However, subsequent to the year while reaffirming the credit rating, ICRA has revised the outlook on rating from 'Stable' to 'Positive'.

OTHER DISCLOSURES

• Related Party Transactions

During the year, there was no materially significant related party transaction which may have potential conflict with the interest of the Company. The Company has formulated a Related Party Transaction Policy which has been uploaded on its website at <http://www.trivenigroup.com/investor/corporate-governance/policies.html>. Details of related party information and transactions are being placed before the Audit Committee from time to time. The details of the related party transactions during the year have been provided in Note No.39 to the financial statements.

- **Disclosures of Accounting Treatment**

In the financial statements for the year ended March 31, 2021, the Company has followed the treatment as prescribed in the applicable Accounting Standards.

- **Disclosures on acceptance of recommendations made by the Board Committees**

During the financial year under review, there was no such instance wherein the Board had not accepted any recommendation of the any Committee of the Board. All the recommendations made by the Committees of the Board were accepted by the Board.

- **Details of Non-Compliance by the Company, penalties, stricture imposed on the Company by the Stock Exchanges, SEBI or any statutory authorities or any matter related to capital markets.**

The Company has complied with all the requirements of the Stock Exchanges / the Regulations and guidelines of SEBI and other Statutory Authorities on all matters relating to capital markets. No penalties or strictures have been imposed by SEBI, Stock Exchanges or any statutory authorities on matters relating to capital markets during the last three years.

- **Whistle Blower Policy and Affirmation that no personnel has been denied access to the Audit Committee**

The Company has established a vigil mechanism through a Whistle Blower Policy for directors and employees to report concerns about unethical behavior, actual or suspected fraud or violation of the Company's code of conduct or ethics policy. The mechanism provides for adequate safeguards against victimisation of director(s)/ employee(s) who express their concerns and also provides for direct access to the Chairperson of the Audit Committee in exceptional cases. During the year under review, no personnel was denied access to the Audit Committee.

- **Disclosures in relation to The Sexual Harassment of Women at Workplace (Prevention, Prohibition and Redressal) Act, 2013**

The Company has formulated a policy on prevention of Sexual Harassment in accordance with the provisions of The Sexual Harassment of Women at Workplace (Prevention, Prohibition and Redressal) Act, 2013 and Rules made thereunder which is aimed at providing every women at the workplace a safe, secure and dignified work environment. No complaint of sexual harassment was received from any women employee during the year.

- **Code for prevention of Insider Trading**

The Company has formulated comprehensive Code of Conduct to regulate, monitor and report trading by Insiders in line with the SEBI (Prohibition of Insider Trading) Regulations, 2015 as amended. The Code lays down the guidelines which advise on procedures to be followed and disclosures to be made, while dealing in shares of the Company and the consequences of non-compliances, including the policy for enquiry in case of leak or suspected leak of Unpublished Price Sensitive Information ('UPSI'). The Company has also adopted Code for Fair Disclosure of UPSI along with Policy for Determination of Legitimate Purposes and the same is available on the Company's website at <http://www.trivenigroup.com/investor/corporate-governance/policies.html>

- **Code of conduct for Directors and Senior Executives**

The Company has laid down a Code of Conduct for all Board Members and the Senior Executives of the Company. The Code of conduct is available on the Company's website www.trivenigroup.com. They have affirmed their compliance with the said code of conduct for the financial year ended March 31, 2021. A declaration to this effect duly signed by the Chairman and Managing Director is given below:

**To the Shareholders of
Triveni Engineering & Industries Ltd.**

Sub.: Compliance with Code of Conduct

I hereby declare that all the Board Members and the Senior Management Personnel have affirmed compliance with the Code of Conduct as adopted by the Board of Directors and applicable to them for the financial year ended March 31, 2021.

Dhruv M. Sawhney

June 29, 2021

Chairman and Managing Director

- **Certification**

The Chairman and Managing Director and Group CFO have certified to the Board of Directors, inter-alia, the accuracy of financial statements and adequacy of internal controls for the financial reporting purpose as required under Regulation 17 (8) of Listing Regulations, for the year ended March 31, 2021. The said certificate forms part of the Annual Report.

Further, as required under Regulation 34(3) and Schedule V Para C clause (10)(i) of the SEBI (Listing Obligations and Disclosure Requirements) Regulations, 2015, a certificate from the Company Secretary in Practice has

been received stating that none of the Directors on the Board have been debarred or disqualified from being appointed or continuing as Directors of Companies by the Board / Ministry of Corporate affairs or any such statutory authority. The said certificate forms part of the Annual Report.

Remuneration to Statutory Auditors

M/s S S Kothari Mehta & Co. (Firm Registration No. 000756N), are holding the office of Statutory Auditors of the Company and one of its wholly owned subsidiaries namely, Mathura Wastewater Management Pvt. Ltd. (MWMPL). The particulars of payment of Statutory Auditors fees on consolidated basis is given below:

Particulars	(Amount in ₹)
Service as Statutory Auditor (including quarterly limited review)	62,45,000
Other matters (including tax audit of MWMPL)	5,45,000
Re-imbursment of out of pocket expenses	24,985
Total	68,14,985

• Details of compliance with mandatory requirements and adoption of the non-mandatory requirements

The details of mandatory requirements are mentioned in this Report. The Company is in compliance with the requirements specified under regulations 17 to 27 and clauses (b) to (i) of sub-regulation (2) of regulation 46 of the Listing Regulations, as applicable, with regard to corporate governance.

The status of adoption of the discretionary requirement as prescribed in Schedule II Part E of the Listing Regulations is as under:

Modified opinion(s) in audit report

The opinion expressed by the Auditor in the audit report on the financial statements for the year ended March 31, 2021 is unmodified.

• Subsidiary Companies

There are ten unlisted Indian wholly owned subsidiary companies viz. Triveni Industries Ltd., Triveni Engineering

Ltd., Triveni Energy Systems Ltd., Triveni Entertainment Ltd., Svastida Projects Ltd., Mathura Wastewater Management Pvt. Ltd. Triveni Sugar Ltd., Gauragi Enterprises Ltd., United Shippers & Dredgers Ltd., and Triveni Foundation (Section 8 Company). None of these subsidiaries is the "Material Non-listed Subsidiary" in terms of Regulation 16(1)(c) of the Listing Regulations. The Company regularly places before the Board, minutes of the unlisted subsidiaries of the Company. The Company has a policy for determining Material Subsidiary which has been uploaded on its website at <http://www.trivenigroup.com/investor/corporate-governance/policies.html>

• Disclosure of commodity price risks and commodity hedging activities

With respect to inputs, the Company is not exposed to any material commodity price risks. However, with respect to the outputs, the Company is exposed to risks relating to the sugar price. In view of lack of adequate depth in commodity exchange/s in India, there is little potential of effective hedging but the Company strives to minimise the risk by an effective sales strategy.

AUDITORS' CERTIFICATE ON COMPLIANCE OF CORPORATE GOVERNANCE

The certificate dated June 29, 2021 from Statutory Auditors of the Company (M/s SS Kothari Mehta & Co.) confirming compliance with the Corporate Governance requirements as stipulated under the Listing Regulations is annexed hereto.

The above report has been adopted by the Board of Directors of the Company at their meeting held on June 29, 2021.

For and on behalf of the Board of Directors

Dhruv M. Sawhney

Chairman and Managing Director

DIN: 00102999

June 29, 2021

Annexure-C

Independent Auditor's Certificate on Corporate Governance

To
The Members of
Triveni Engineering & Industries Limited

We have examined the compliance of conditions of Corporate Governance by Triveni Engineering & Industries Limited ("the Company") for the year ended March 31, 2021, as stipulated in Regulations 17 to 27 and clause (b) to (i) of Regulation 46 (2) and paragraphs C, D and E of Schedule V of the Securities and Exchange Board of India (Listing Obligations and Disclosure Requirements) Regulations, 2015 as amended ('Listing Regulations') pursuant to the Listing Agreement of the Company with Stock Exchanges.

MANAGEMENT'S RESPONSIBILITY

The compliance of the Corporate Governance Report is the responsibility of the Management of the Company including the preparation and maintenance of all relevant supporting records and documents. This responsibility also includes the design, implementation and maintenance of internal control relevant to ensure the compliance with the conditions of Corporate Governance as stipulated in the Listing Regulations, issued by the Securities and Exchange Board of India.

AUDITOR'S RESPONSIBILITY

Our examination was limited to procedures and implementation thereof, adopted by the Company for ensuring the compliance of the terms and conditions of Corporate Governance. It is neither an audit nor an expression of opinion on the financial statements of the Company.

We have examined the relevant records and documents maintained by the Company for the purposes of providing reasonable assurance on the compliance with Corporate Governance requirements by the Company.

Pursuant to the requirements of the Listing Regulations, it is our responsibility to provide a reasonable assurance whether the Company has complied with the conditions of Corporate Governance as stipulated in Listing Regulations for the year ended March 31, 2021.

We have carried out an examination of the relevant records of the Company in accordance with the Guidance Note on Certification of Corporate Governance issued by the Institute of the Chartered Accountants of India (the ICAI), the Standards on Auditing specified under Section 143(10) of the Companies Act 2013, in so far as applicable for the purpose of this certificate and as per the Guidance Note on Reports or Certificates for Special Purposes issued by the ICAI which requires that we comply with the ethical requirements of the Code of Ethics issued by the ICAI.

We have complied with the relevant applicable requirements of the Standard on Quality Control (SQC) 1, Quality Control for Firms that Perform Audits and Reviews of Historical Financial Information, and Other Assurance and Related Services Engagements.

OPINION

Based on our examination of the relevant records and according to the information and explanations provided to us and the representations provided by the Management, we certify that the Company has complied with the conditions of Corporate Governance as stipulated in regulations 17 to 27 and Clauses (b) to (i) of Regulation 46(2) and para C, D and E of Schedule V of the Listing Regulations during the year ended March 31, 2021.

We state that such compliance is neither an assurance as to the future viability of the Company nor the efficiency or effectiveness with which the Management has conducted the affairs of the Company.

RESTRICTION ON USE

This certificate is issued solely for the purpose of complying with the aforesaid regulations and may not be suitable for any other purpose.

For **S. S. Kothari Mehta & Company**
Chartered Accountants
Firm Registration No. 000756N

Yogesh K. Gupta
Partner

Membership No. 093214
UDIN: 21093214AAAAEA6755

Place: Faridabad (Haryana)
Dated: June 29, 2021

CEO/CFO Certification

To
The Board of Directors
Triveni Engineering & Industries Limited

Sub : CEO / CFO certification under Regulation 17(8) of Listing Agreement

We, Dhruv M. Sawhney, Chairman and Managing Director and Mr. Suresh Taneja, Group CFO certify to the Board that:

- (a) We have reviewed financial statements and the cash flow statement for the year ended March 31, 2021 and that to the best of our knowledge and belief:
 - (i) These statements do not contain any materially untrue statement or omit any material fact or contain statements that might be misleading;
 - (ii) These statements together present a true and fair view of the company's affairs and are in compliance with existing accounting standards, applicable laws and regulations.
- (b) There are, to the best of our knowledge and belief, no transactions entered into by the company during the year which are fraudulent, illegal or violative of the company's code of conduct.
- (c) We accept responsibility for establishing and maintaining internal controls for financial reporting and that we have evaluated the effectiveness of internal control systems of the company pertaining to financial reporting and we have disclosed to the auditors and the Audit Committee, deficiencies in design or operation of such internal controls, if any, of which we are aware and the steps we have taken or propose to take to rectify these deficiencies.
- (d) We have indicated to the auditors and the Audit Committee:
 - (i) That there were no significant changes in internal control over financial reporting during the year;
 - (ii) There are no significant changes in accounting policies during the year and;
 - (iii) That there were no instances of significant fraud, of which we have become aware and the involvement therein, if any, of the management or an employee having a significant role in the company's internal control system over financial reporting.

Suresh Taneja
Group CFO

Dhruv M. Sawhney
Chairman and Managing Director

June 29, 2021

Certificate of Non-Disqualification of Directors

(Pursuant to Regulation 34(3) and Schedule V Para C clause (10)(i) of the SEBI (Listing Obligations and Disclosure Requirements) Regulations, 2015)

To
The Members of
M/s Triveni Engineering & Industries Limited
Deoband, District Saharanpur,
Uttar Pradesh-247554

We have examined the relevant registers, records, forms, returns and disclosures received from the Directors of TRIVENI ENGINEERING & INDUSTRIES LIMITED having CIN-L15421UP1932PLC022174 and having registered office at DEOBAND, SAHARANPUR, UTTAR PRADESH- 247554 (hereinafter referred to as 'the Company'), produced before us by the Company for the purpose of issuing this Certificate, in accordance with Regulation 34(3) read with Schedule V Para-C Sub clause 10(i) of the Securities Exchange Board of India (Listing Obligations and Disclosure Requirements) Regulations, 2015.

In our opinion and to the best of our information and according to the verifications (including Directors Identification Number (DIN) status at the portal www.mca.gov.in) as considered necessary and explanations furnished to us by the Company & its officers, We hereby certify that none of the Directors on the Board of the Company as stated below for the Financial Year ending on March 31, 2021 have been debarred or disqualified from being appointed or continuing as Directors of companies by the Securities and Exchange Board of India and Ministry of Corporate Affairs or any such other Statutory Authority.

Sl. No.	Name of Director	DIN	Date of appointment in Company
1	Mr. Dhruv Manmohan Sawhney	00102999	20/09/1992
2	Mr. Tarun Sawhney	00382878	19/11/2008
3	Mr. Nikhil Sawhney	00029028	19/11/2008
4	Ms. Homai Ardeshir Daruwalla	00365880	07/11/2013
5	Mr. Santosh Pande	01070414	16/04/2014
6	Mr. Shekhar Datta	00045591	25/04/2009
7	Mr. Sudipto Sarkar	00048279	07/11/2015
8	Mr. Jitendra Kumar Dadoo	02481702	21/05/2019

Ensuring the eligibility of for the appointment / continuity of every Director on the Board is the responsibility of the management of the Company. Our responsibility is to express an opinion on these based on our verification. This certificate is neither an assurance as to the future viability of the Company nor of the efficiency or effectiveness with which the management has conducted the affairs of the Company.

For **Suresh Gupta & Associates**
Company Secretaries

Suresh Gupta
(Proprietor)
FCS No. 5660
C. P. No. 5204

Date: June 29, 2021
Place: Noida

Peer Review Cert. No.740/2020
UDIN: F005660C000534091

Annexure-D

Form No. MR-3**SECRETARIAL AUDIT REPORT****For The Financial Year Ended March 31, 2021**

[Pursuant to section 204(1) of the Companies Act, 2013 and rule No.9 of the Companies (Appointment and Remuneration Personnel) Rules, 2014]

To,

The Members,
Triveni Engineering and Industries Limited
(CIN: L15421UP1932PLC022174)
Deoband, District Saharanpur,
Uttar Pradesh-247 554.

We have conducted the secretarial audit of the compliance of applicable statutory provisions and the adherence to good corporate practices by Triveni Engineering and Industries Limited (hereinafter called the "Company"). Secretarial Audit was conducted in a manner that provided us a reasonable basis for evaluating the corporate conducts/statutory compliances and expressing our opinion thereon.

We report that-

- a) Maintenance of secretarial record is the responsibility of the management of the Company. Our responsibility is to express an opinion on these secretarial records based on our audit.
- b) We have followed the audit practices and processes as were appropriate to obtain reasonable assurance about the correctness of the contents of the secretarial records. The verification was done on test basis to ensure that correct facts are reflected in secretarial records. We believe that the processes and practices, we followed provide a reasonable basis for our opinion.
- c) We have not verified the correctness and appropriateness of the financial statements of the Company.
- d) Where ever required, we have obtained the Management representation about the compliances of laws, rules and regulations and happening of events etc.
- e) The compliance of the provisions of the Corporate and other applicable laws, rules, regulation, standards is the responsibility of the management. Our examination was limited to the verification of procedures on test basis.

- f) The Secretarial Audit report is neither an assurance as to the future viability of the company nor of the efficacy or effectiveness with which the management has conducted the affairs of the Company.

Based on our verification of the Company's books, papers, minute books, forms and returns filed and other records maintained by the Company and also the information provided by the Company, its officers, agents and authorized representatives during the conduct of Secretarial Audit, we hereby report that in our opinion, the company has, during the audit period covering the financial year ended on March 31, 2021 ("Audit Period") complied with the statutory provisions listed hereunder and also that the Company has proper Board processes and compliance mechanism in place to the extent, in the manner and subject to the reporting made hereinafter:

We have examined the books, papers, minute books, forms and returns filed and other records maintained by the company for the financial year ended on March 31, 2021 according to the provisions of:

- (i) The Companies Act, 2013 (the Act) and the rules made thereunder;
- (ii) The Securities Contracts (Regulation) Act, 1956 ('SCRA') and the rules made thereunder;
- (iii) The Depositories Act, 1996 and the Regulations and Bye-laws framed thereunder;
- (iv) Foreign Exchange Management Act, 1999 and the rules and regulations made thereunder to the extent of Foreign Direct Investment, Overseas Direct Investment and External Commercial Borrowings;
- (v) The following Regulations and Guidelines prescribed under the Securities and Exchange Board of India Act, 1992 ('SEBI Act'):-
 - (a) The Securities and Exchange Board of India (Substantial Acquisition of Shares and Takeovers) Regulations, 2011;

- (b) The Securities and Exchange Board of India (Prohibition of Insider Trading) Regulations, 2015;
- (c) *The Securities and Exchange Board of India (Issue of Capital and Disclosure Requirements) Regulations, 2018;
- (d) *Securities and Exchange Board of India (Share Based Employee Benefits) Regulations, 2014;
- (e) *The Securities and Exchange Board of India (Issue and Listing of Debt Securities) Regulations, 2008;
- (f) The Securities and Exchange Board of India (Registrars to an Issue and Share Transfer Agents) Regulations, 1993 regarding the Companies Act and dealing with client;
- (g) *The Securities and Exchange Board of India (Delisting of Equity Shares) Regulations, 2009;
- (h) The Securities and Exchange Board of India (Buyback of Securities) Regulations, 2018;
- (i) The Securities and Exchange Board of India (Listing Obligations and Disclosure Requirements) Regulations, 2015.

*No event took place under these Regulations during the Audit period.

We have also examined compliance with the applicable clauses of the Secretarial Standards on Meetings of the Board of Directors and General Meetings issued by The Institute of Company Secretaries of India.

During the period under review, the Company has complied with the provisions of the Act, Rules, Regulations, Guidelines and Standards, to the extent applicable, as mentioned above.

- (vi) Some of the other laws specifically applicable to the company are as under:-
- The Food Safety and Standards Act, 2006
 - Essential Commodities Act, 1955
 - Indian Boilers Act, 1923
 - U.P. Sugarcane (Purchase Tax) Act, 1961
 - U.P. Sheera Niyam Adhinyam, 1964
 - Legal Metrology Act, 2009
 - The Electricity Act, 2003

We have checked the compliance management system of the Company to obtain reasonable assurance about

the adequacy of systems in place to ensure compliance of specifically applicable laws and this verification was done on test basis. In our opinion and to the best of our information and according to explanations given to us, we believe that the compliance management system of the Company is adequate to ensure compliance of laws specifically applicable to the Company.

We further report that the Board of Directors of the Company is duly constituted with proper balance of Executive Directors, Non-Executive Directors and Independent Directors. The changes in the composition of the Board of Directors that took place during the period under review were carried out in compliance with the provisions of the Act.

Adequate notices were given to all directors of the Board Meetings. Agenda and detailed notes on agenda were sent in advance and a system exists for seeking and obtaining further information and clarifications on the agenda items before the meeting for meaningful participation at the meeting.

Board decisions are carried out with unanimous consent and therefore, no dissenting views were required to be captured and recorded as part of the minutes.

We further report that there are adequate systems and processes in the company commensurate with the size and operations of the company to monitor and ensure compliance with applicable laws, rules, regulations, standards and guidelines.

We further report that during the audit period, the Company has completed the Buy-back of shares approved on August 10, 2020 by the Board of Directors of the Company. Pursuant to the offer, the Company has bought back and extinguished 61,90,000 equity shares of Re.1/- each at a price of ₹ 105/- per share aggregating to ₹ 64,99,50,000 representing 2.5% of the issued, subscribed and paid capital of the Company and except the above there was no other specific event / action which would have a major bearing on the Company's affairs in pursuance of the above referred laws, rules, regulations, standards, guidelines, etc.

For **Suresh Gupta & Associates**
Company Secretaries

Suresh Gupta
Proprietor
FCS No.:5660
CP No.:5204

Date: June 29, 2021
Place: Noida

Peer Review Cert. No.: 740/2020
UDIN: F005660C000534023

Annexure-E

ANNUAL REPORT ON CORPORATE SOCIAL RESPONSIBILITY (CSR) ACTIVITIES

For the Financial Year Ended March 31, 2021

1. Brief outline on CSR Policy of the Company:

The CSR Policy is to lay down guidelines for the Company to make CSR as one of the key focus areas for the well being of people, providing employment potential to them and preserving environment.

2. Composition of CSR committee:

Sl. No.	Name of Director	Designation/ Nature of Directorship	Number of meetings of CSR Committee held during the year	Number of meetings of CSR Committee attended during the year
1.	Ms. Homai A. Daruwalla	Chairperson/Non-Executive Independent Director	2	2
2.	Dr. Santosh Pande	Member/Non-Executive Independent Director	2	2
3.	Mr. Tarun Sawhney	Member/Promoter & Executive Director	2	2
4.	Mr. Nikhil Sawhney	Member/Promoter & Non Executive Director	2	2

3. Provide the web-link where Composition of CSR committee, CSR Policy and CSR projects approved by the board are disclosed on the website of the company:

Particular	Web-link
Composition	https://www.trivenigroup.com/corporate-governance
CSR Policy	https://www.trivenigroup.com/files/policies/CSR%20Policy.pdf
CSR Projects	https://www.trivenigroup.com/community

4. Provide the details of Impact assessment of CSR projects carried out in pursuance of sub-rule (3) of rule 8 of the Companies (Corporate Social Responsibility Policy) Rules, 2014, if applicable (attach the report):

Not applicable

5. Details of the amount available for set off in pursuance of sub-rule (3) of rule 7 of the Companies (Corporate Social Responsibility Policy) Rules, 2014 and amount required for set off for the financial year, if any : Nil

Sl. No.	Financial Year	Amount available for set-off from preceding financial years (in ₹)	Amount required to be set-off for the financial year, if any (in ₹)*
1.	Not Applicable	Nil	Nil

*the Company has not availed any setoff benefits.

6. Average net profit of the company as per section 135(5):

The average net profit of the Company for the preceding three financial years was ₹ 20834.53 lakhs.

7. (a) Two percent of average net profit of the company as per section 135(5): ₹ **416.69 lakhs**
- (b) Surplus arising out of the CSR projects or programmes or activities of the previous financial years: **Nil**
- (c) Amount required to be set off for the financial year, if any: **Nil**
- (d) Total CSR obligation for the financial year (7a+7b-7c): ₹ **416.69 lakhs**

8. (a) CSR amount spent or unspent for the financial year:

Total Amount Spent for the Financial Year (in ₹ lakhs)	Amount Unspent (in ₹ lakhs)				
	Total Amount transferred to Unspent CSR Account as per section 135(6)		Amount transferred to any fund specified under Schedule VII as per second proviso to section 135(5).		
	Amount	Date of transfer	Name of the Fund	Amount	Date of transfer
440.29	Nil	NA	NA	Nil	NA

(b) Details of CSR amount spent against ongoing projects for the financial year:

(1)	(2)	(3)	(4)	(5)	(6)	(7)	(8)	(9)	(10)	(11)
Sl. No.	Name of the Project	Item from the list of activities in Schedule VII to the Act	Local area (Yes/No)	Location of the project State District	Project duration	Amount allocated for the project (in ₹ lakhs)	Amount spent in the current financial Year (in ₹ lakhs)	Amount transferred to Unspent CSR Account for the project as per Section 135(6) (in ₹ lakhs)	Mode of Implementation - Direct (Yes/No)	Mode of Implementation - Through Implementing Agency Name CSR Registration number
----- Nil -----										

(c) Details of CSR amount spent against other than ongoing projects for the financial year:

(1)	(2)	(3)	(4)	(5)	(6)	(7)	(8)
Sl. No.	Name of the Project	Item from the list of activities in schedule VII to the Act	Local area (Yes/ No)	Location of the project State District	Amount spent for the project (in ₹)	Mode of implementation - Direct (Yes/No)	Mode of Implementation - Through Implementing Agency Name CSR registration number
1	Support to Nursing School	Education & Training	Yes	Delhi Delhi	36.00	No	Tirath Ram Shah Charitable Hospital CSR00008746
2	Support to School at Deoband	Education & Training	Yes	U.P. Saharanpur	68.00	Yes	-
3	Soil Health Analysis and fertilizer incentive Program	Ecological Balance and Maintaining Quality of Soil Air and Water	Yes	U.P. Sugar Units at various locations	172.86	Yes	-
4	WASSER 2020-21 Research and development for optimization of resource usage through application of state-of-art techniques for effective resource management	Environmental Sustainability	No All India	All India	30.00	No	CII-Triveni Water Institute -through Triveni Foundation
5	Support for developing a digital water platform for generating knowledge awareness to enable new insights into water management	Environmental Sustainability	No All India	All India	30.00	No	CII-Triveni Water Institute -through Triveni Foundation
6	Sanitation program for the prevention and spread of Covid-19.	Health care	Yes	Delhi Delhi	26.05	No	Tirath Ram Shah Charitable Hospital CSR00008746
7	Cancer Screening Program for Women	Health care	Yes	Delhi Delhi	32.38	No	Tirath Ram Shah Charitable Hospital CSR00008746
8	Supporting football for children & youth in villages / small schools	Promoting Sports	No North India	North India	5.00	No	India Youth Soccer Association (IYSA) -through Triveni Foundation
9	Prime Minister Relief Fund		No All India	All India	40.00	No	Prime Minister Relief Fund
Total					440.29		

- (d) **Amount spent in Administrative Overhead:** Nil
- (e) **Amount spent on Impact Assessment, if applicable:** Not applicable
- (f) **Total amount spent for the Financial Year (8b+8c+8d+8e):** ₹ 440.29 lakhs
- (g) **Excess amount for set off, if any:**

Sl. No.	Particular	Amount (in ₹ lakhs)
(i)	Two percent of average net profit of the company as per section 135(5)	416.69
(ii)	Total amount spent for the Financial Year	440.29
(iii)	Excess amount spent for the financial year [(ii)-(i)]	23.60
(iv)	Surplus arising out of the CSR projects or programmes or activities of the previous financial years, if any	Nil
(v)	Amount available for set off in succeeding financial years [(iii)-(iv)]	23.60

9. (a) **Details of Unspent CSR amount for the preceding three financial years:**

Sl. No.	Preceding Financial Year	Amount transferred to Unspent CSR Account under section 135 (6) (in ₹)	Amount spent in the reporting Financial Year (in ₹)	Amount transferred to any fund specified under Schedule VII as per section 135(6), if any.			Amount remaining to be spent in succeeding financial years. (in ₹)
				Name of the Fund	Amount (in ₹)	Date of transfer	
Nil							

(b) **Details of CSR amount spent in the financial year for ongoing projects of the preceding financial year(s):**

(1)	(2)	(3)	(4)	(5)	(6)	(7)	(8)	(9)
Sl. No.	Project ID	Name of the Project	Financial Year in which the project was commenced	Project duration	Total amount allocated for the project (in ₹)	Amount spent on the project in the reporting Financial Year (in ₹)	Cumulative amount spent at the end of reporting Financial Year (in ₹)	Status of the project - Completed / Ongoing
----- Nil -----								

10. **In case of creation or acquisition of capital asset, furnish the details relating to the asset so created or acquired through CSR spent in the financial year (asset-wise details):** NA

- (a) **Date of creation or acquisition of the capital asset(s) :** NA
- (b) **Amount of CSR spent for creation or acquisition of capital asset :** Nil
- (c) **Details of the entity or public authority or beneficiary under whose name such capital asset is registered, their address etc :** NA
- (d) **Provide details of the capital asset(s) created or acquired (including complete address and location of the capital asset) :** NA

11. **Specify the reason(s), if the company has failed to spend two per cent of the average net profit as per section 135(5):** Not Applicable

For and on behalf of the Board of Directors

Homai A. Daruwalla
 Chairperson – CSR Committee
 DIN: 00365880

Dhruv M. Sawhney
 Chairman and Managing Director
 DIN: 00102999

June 29, 2021

Annexure-F

A) CONSERVATION OF ENERGY

a) The steps taken or impact on conservation of energy

1. The change in manufacturing process to produce raw sugar for exports at three sugar units and B-heavy molasses for production of ethanol at four sugar units led to significant reduction in process steam and power consumption and thereby conservation of energy.
2. Installed a fan-less 200 M³/Hr capacity cooling tower for power turbines oil coolers, mill turbines oil coolers and mill bearing cooling resulting in reduction of ground water utilization and consequently power consumption as earlier a tube well was being used for this at Deoband Sugar Unit.
3. Extensive insulation at boiler, steam lines, condensate lines and vapour lines in boiling house to reduce heat losses and consequently bagasse savings at Khatauli Sugar Unit.
4. Modified the economiser of the boiler to improve the outlet temperature of water, resulting in improvement in bagasse saving due to better steam-fuel ratio at Khatauli Sugar unit.
5. Reduction in mill RPM resulted in reduced bagasse moisture consequently improving the steam-fuel ratio at Khatauli Sugar Unit.
6. Enhanced the heating surface area of PHE in the CPU stream at Cogeneration unit at Khatauli, resulting in higher return condensate recovery from the sugar unit thereby improving efficiency of the boiler and bagasse savings.
7. Insulation/lagging at exposed surfaces of the boiler, evaporator and pan station, steam and vapour lines to reduce heat losses at Chandanpur and Milaknarayanpur Sugar Units.
8. Installed VFD at the B-heavy molasses pump and operated the pump on 50 % lesser power consumption, resulting in saving the energy at Raninangal Sugar Unit.

9. Installed a 200 KVAR capacitor bank at Raninangal and Chandanpur Sugar Units resulting in improvement in the power factor and thus savings of power.
10. Installed new flow meters to measure and control the consumption of process water in various operations at Khatauli, Deoband, Chandanpur and Sabitgarh Sugar Units.
11. Converted clear juice heating from single stage to double stage heating by installing new direct contact heater resulting in steam saving at Sabitgarh Sugar Unit.
12. Automation of two Pans resulted in stoppage of one injection pump of about 100 KW throughout the season at Ramkola Sugar Unit.
13. Replaced three old 112 KW motors with the energy efficient motors at Ramkola Sugar Unit.
14. Installed planetary drive resulting in reduction in power consumption at dry seed crystallizer at Ramkola Sugar Unit.
15. Optimal utilization of furnace capacity through better planning and clubbing of jobs in each charge resulted in reduction in specific electrical energy consumption per ton of material heat treated by at our Power Transmission Business in Mysuru.
16. Continued replacement of conventional lightings with energy efficient LED lights at our various business locations.

b) The steps taken by the Company for utilising alternate source of energy

- At Power Transmission Business, arrangements have been made to source significant portion of its power requirement, generated from wind energy, an alternate renewable source of power.
- Solar panels/cells are being used at cane zonal offices of Raniangal unit and at out-centre cane weighbridges for lighting and other uses at Ramkola unit.

Apart from above, in all sugar units of the Company, majority of power is generated through bagasse, which is a renewable source of energy.

c) The capital investment on energy conservation equipment

The Company has incurred ₹ 58 lakhs towards energy conservation equipment during the year.

B) TECHNOLOGY ABSORPTION

(i) The efforts made towards technology absorption;

All our businesses use mostly indigenous technology except for Power Transmission Business ("PTB"), which apart from own technology up to 7.5 MW, gets technology under Licence Agreements. PTB is self-sufficient in the application of the technologies obtained under the License Agreements. The Business is also involved in R&D activities to develop fundamental understanding of technology, to evolve other products and to also improve upon existing range of products.

(ii) The benefits derived like product improvement, cost reduction, product development or import substitution

Both our engineering businesses are continually engaged in the improvement of the product features and value engineering so as to be cost competitive in the market place and to protect their margins.

(iii) In case of imported technology (imported during the last three years reckoned from the beginning of the financial year)-

a) the details of technology imported *	No technology was imported during the last three years.
b) the year of import	NA
c) whether the technology has been fully absorbed	NA
d) if not fully absorbed, areas where absorption has not taken place and reasons thereof;	NA

*The Power Transmission Business has a License Agreement with an overseas party under which limited information by way of drawings is provided to undertake manufacture of the product and as such, the underlying technology is not passed. However, the Business leverages its knowledge and undertakes internal R&D to develop new products / applications.

C) FOREIGN EXCHANGE EARNINGS & OUTGO

Earnings in foreign exchange	₹ 1571.91 lakhs
Foreign exchange outgo	₹ 3782.73 lakhs *

*include advancing a loan of ₹ 1733.60 lakhs to an associate company

For and on behalf of the Board of Directors

Dhruv M. Sawhney

Chairman and Managing Director

DIN: 00102999

June 29, 2021

Annexure-G

Particulars of Employees Pursuant to Section 197 (12) of the Companies Act, 2013 ('ACT') Read with Rule 5(1) of the Companies (Appointment and Remuneration of Managerial Personnel) Rules, 2014

- (i) The percentage increase in remuneration of each Director, CFO and CS during the FY 21, ratio of remuneration of each Director to the median remuneration of the employees of the Company for the FY 21

Name of Director/KMP and Designation	Ratio of remuneration to Median remuneration	% increase of remuneration in FY 21
(i) Mr. Dhruv M. Sawhney* ¹ Chairman and Managing Director (CMD)	N.A.	N.A.
(ii) Mr. Tarun Sawhney* ² Vice Chairman and Managing Director (VCMD)	150.21	16.92%
(iii) Mr. Nikhil Sawhney Non-Executive Director	12.61	31.88%
(iv) Mr. Shekhar Datta Non-Executive Independent Director	5.72	25.32%
(v) Ms. Homai A. Daruwalla Non-Executive Independent Director	6.00	36.84%
(vi) Dr. Santosh Pande Non-Executive Independent Director	4.76	6.74%
(vii) Mr. Sudipto Sarkar Non-Executive Independent Director	5.08	22.22%
(viii) Mr. Jitendra Kumar Dadoo Non-Executive Independent Director	4.16	16.13%
(ix) Mr. Suresh Taneja* ² Group Chief Financial Officer	53.90	3.19%
(x) Ms. Geeta Bhalla* ² Group Vice President & Company Secretary	22.08	9.67%

*1 No salary is being drawn by the CMD.

*2 Gratuity is provided based on actuarial valuation and hence, remuneration does not include gratuity.

Note:

- The remuneration to Non-Executive Independent Directors includes commission in accordance with the relevant provisions of the Companies Act, 2013 due to better profitability.
- In the Financial year 2020 – 21, the annual median remuneration was at ₹ 4.33 lakhs and there was an increase of 5.88% in the median remuneration of the employees as compared to last year (The salaries of seasonal employees in sugar units have not been considered herein as they are deployed only for the duration of the Sugar season and not for the entire year).
- There were 3872 permanent employees (896 officers, 2976 workmen including 1608 seasonal employees) on the rolls of the Company as on March 31, 2021.
- The average percentage salary increases of employees other than managerial personnel was 5.68% against 16.92% in the managerial remuneration (pertaining to VCMD). There has been no increase in the salary of VCMD during FY21. The increase in remuneration is on account of higher performance bonus as per approvals of Board and Shareholders' in accordance with the relevant provisions of the Companies Act, 2013, due to better profitability. Further, the increase in remuneration is in line with considerable management effort to plan, implement and achieve improvement in operational efficiencies of the Sugar Business, which will help the Company to better withstand cyclicity in the sugar industry.
- It is hereby affirmed that the remuneration paid during the financial ended March 31, 2021 is as per the Nomination and Remuneration policy of the Company.

For and on behalf of the Board of Directors

Dhruv M. Sawhney

Chairman and Managing Director

DIN: 00102999

June 29, 2021

Annexure-I

Business Responsibility Report – 2020-21

SECTION A: GENERAL INFORMATION ABOUT THE COMPANY

1	Corporate Identity Number (CIN) of the Company	L15421UP1932PLC022174														
2	Name of the Company	Triveni Engineering & Industries Limited														
3	Registered Address	Deoband, District Saharanpur, Uttar Pradesh- 247554														
4	Website	www.trivenigroup.com														
5	E-mail ID	shares@trivenigroup.com														
6	Financial Year reported	2020-21														
7	Sector(s) that the Company engaged in (industrial activity code-wise)	<table border="1"> <thead> <tr> <th>NIC Code</th> <th>Product Description</th> </tr> </thead> <tbody> <tr> <td>1072</td> <td>Sugar</td> </tr> <tr> <td>35106</td> <td>Cogeneration (Power)</td> </tr> <tr> <td>1101</td> <td>Industrial Alcohol including Ethanol, Potable Alcohol and Potable Liquor</td> </tr> <tr> <td>20239</td> <td>Hand Sanitizer</td> </tr> <tr> <td>281</td> <td>Industrial Gears</td> </tr> <tr> <td>360</td> <td>Water & Waste Water Treatment</td> </tr> </tbody> </table>	NIC Code	Product Description	1072	Sugar	35106	Cogeneration (Power)	1101	Industrial Alcohol including Ethanol, Potable Alcohol and Potable Liquor	20239	Hand Sanitizer	281	Industrial Gears	360	Water & Waste Water Treatment
NIC Code	Product Description															
1072	Sugar															
35106	Cogeneration (Power)															
1101	Industrial Alcohol including Ethanol, Potable Alcohol and Potable Liquor															
20239	Hand Sanitizer															
281	Industrial Gears															
360	Water & Waste Water Treatment															
8	List three key products/services that the Company manufactures/ provides	Sugar and Ethanol Industrial Gears (High speed Gears) Solutions relating to Waste Water, Sewage and Effluents														
9	Total number of location where business activity is undertaken by the Company	<p>(a) Number of International Locations (Provide details of major 5) The Company is majorly operating in domestic market. Water segment of the company has won an Overseas job in country of Maldives which will be undertaken in next FY'22</p> <p>(b) Number of National Locations: Uttar Pradesh (UP) - 03 Sugar manufacturing plants in West UP, 03 in Central UP and 01 in East UP; - 04 cogenerations plants in 3 sugar units in West UP, 02 in Central UP; - 02 Distilleries situated in West U.P. (Muzaffarnagar and Sabitgarh). - Water Business at Noida, with projects being executed all over India - IMIL & Hand Sanitizers manufacturing plants at Muzaffarnagar (UP) - Corporate and Registered Offices at Noida & Deoband respectively.</p> <p>(c) Karnataka - Manufacturing facilities of High Speed & Niche Low speed Gears and other equipment at Mysuru.</p>														
10	Markets served by the Company: Local/State/ National/ International	<table border="1"> <tbody> <tr> <td>Local</td> <td>Yes</td> </tr> <tr> <td>State</td> <td>Yes</td> </tr> <tr> <td>National</td> <td>Yes</td> </tr> <tr> <td>International</td> <td>Yes*</td> </tr> </tbody> </table>	Local	Yes	State	Yes	National	Yes	International	Yes*						
Local	Yes															
State	Yes															
National	Yes															
International	Yes*															

* mainly through exports by Power Transmission Business and exports by Sugar Business either directly or through merchant exporters

SECTION B: FINANCIAL DETAILS OF THE COMPANY.**Triveni Engineering & Industries Limited**

	FY-21 Standalone ₹ Lakhs	FY-21 Consolidated ₹ Lakhs
1 Paid-up Capital	2417.57	2417.57
2 Total Income	472750.64	473374.98
(a) Revenue from operations	469320.49	470335.14
(b) Other income	3430.15	3039.84
3 Profit for the year (after taxes and minority interest)	27330.86	29460.27
4 Total Comprehensive Income	27302.00	29399.53
5. Total Spending on Corporate Social Responsibility (CSR) as percentage of profit before tax	0.96% of Profit before tax of FY 2020-21 and 2% of average profit of last three years.	
6. List of activities in which expenditure in 5 above has been incurred	1. Education 2. Healthcare 3. Environmental sustainability, ecological balance and maintaining quality of soil, air and water 4. Training to promote nationally recognized sports 5. Contribution to Prime Minister Relief Fund	

SECTION C: OTHER DETAILS**1. Does the Company have any Subsidiary Company/ Companies?**

Yes, the Company has ten subsidiaries as on March 31, 2021.

2. Do the Subsidiary Company/Companies participate in the BR Initiatives of the parent company? If yes, then indicate the number of such subsidiary company(s).

The Subsidiary Companies are in the nascent stages of setting up their respective businesses and hence, these do not have any active participation in the BR initiatives. However, one subsidiary company, Mathura Wastewater Management Private Limited has carried out substantial business activities in the third year of operation and endeavors to follow the BR initiative of the parent company.

3. Do any other entity/entities (e.g. suppliers, distributors etc.) that the Company does business with, participate in the BR initiatives of the Company?

While the suppliers or distributors are not directly involved in the BR initiatives pursued by the Company, the Company arranges with third parties to provide their expertise, products and services for the benefit of the farmers who are the supply chain partners to the Company. Further, the Company also engages with the farmers directly to provide expert knowledge on latest farming techniques and prevention of disease to the crop

If yes, then indicate the percentage of such entity/entities? [Less than 30%, 30-60%, More than 60%].

Not Applicable

SECTION D: BR INFORMATION**1. Details of Director/Directors responsible of BR**

a) Details of the Director/Director responsible for implementation of the BR policy/policies

DIN No: 00382878

Name: Mr. Tarun Sawhney

Designation: Vice Chairman and Managing Director

b) Details of the BR head*

Sl. No.	Particulars	Details
1.	DIN Number (if applicable)	Not applicable
2.	Name & Designation	Mr Sameer Sinha, President-Sugar Business Group & Corporate Planning Mr. Rajiv Rajpal, CEO-Power Transmission Business Mr. Kamal Verma, CEO-Water Business
3.	Telephone number	0120-4308000 0821-4280501 0120-4748000
4.	e-mail id	ssinha@ho.trivenigroup.com rajivrajpal@ptb.trivenigroup.com kamal.verma@projects.trivenigroup.com

2. Principle-wise (as per NVGs) BR Policy/policies:

The National Voluntary Guidelines on Social, Environmental and Economic Responsibilities of Business (NVGs) released by the Ministry of Corporate Affairs has adopted nine areas of Business Responsibility. These briefly are as follows:

-
- P1** Business should conduct and govern themselves with ethics, Transparency and Accountability.
 - P2** Businesses should provide goods and services that are safe and contribute to sustainability throughout their life cycle.
 - P3** Businesses should promote the well-being of all employees.
 - P4** Businesses should respect the interests of, and be responsive towards all stakeholders, especially those who are disadvantaged, vulnerable and marginalized.
 - P5** Businesses should respect and promote human rights.
 - P6** Business should respect, protect, and make efforts to restore the environment.
 - P7** Businesses, when engaged in influencing public and regulatory policy, should do so in a responsible manner.
 - P8** Businesses should support inclusive growth and equitable development.
 - P9** Businesses should engage with and provide value to their customers and consumers in a responsible manner.
-

a. Details of compliance:

Sl. No.	Questions	P1	P2	P3	P4	P5	P6	P7	P8	P9
1	Do you have policy/policies for BR?					Yes				
2	Has the policy being formulated in consultation with the relevant stakeholder?	The Company has formulated the policies, SOPs and adopted best practices by considering inputs, feedback and sensitivities of the stakeholders, wherever practicable.								
3	Does the policy conform to any national/international standards? If yes, specify? (50 words)	Yes, the policies/practices broadly conform to the National Voluntary Guidelines (NVGs) issued by the Ministry of Corporate Affairs, Government of India, and the policies are compliant with applicable laws as mapped against the principles mentioned in NVGs.								
4	Has the policy being approved by the Board? If yes, has it been signed by MD/owner/CEO/appropriate Board Director?	Yes, the Board of Directors of the Company has approved the BR Policy and the same has been signed by the VCMD, pursuant to the authorization by the Board.								
5	Does the company have a specified committee of the Board/Director/Official to oversee the implementation of the policy?					Yes				
6	Indicate the link for the policy to be viewed online?	The link for the Policies: www.trivenigroup.com								
7	Has the policy been formally communicated to all relevant internal and external stakeholders?	The internal stakeholders have been made aware of the policies through appropriate means of communication. For the external stakeholders, the policy has been posted on the Company's website and they have also being made aware of details of such policy and about its availability on the website of the Company								
8	Does the company have in-house structure to implement the policy/policies					Yes				
9	Does the Company have a grievance redressal mechanism related to the policy/policies to address stakeholders' grievances related to the policy/policies?					Yes				
10	Has the company carried out independent audit/evaluation of the working of this policy by an internal or external agency?	There is an adequate system in force to ensure effective implementation. The audit by an external agency will be arranged in the due course.								

- b. If answer to the question at Sl.No. 1 against any principle, is “No” please explain why: (Tick up to 2 options):

Sl. No.	Questions	P1	P2	P3	P4	P5	P6	P7	P8	P9
1	The company has not understood the Principles									
2	The Company is not at a stage where it finds itself in a position to formulate and implement the policies on specified principles.									
3	The Company does not have financial or manpower resources available for the task.									NOT APPLICABLE
4	It is planned to be done within next 6 months									
5	It is planned to be done within next 1 year									
6	Any other reason (please specify)									

3. Governance related to BR

- Indicate the frequency with which the Board of Directors, Committee of the Board or CEO to access the BR performance of the Company. Within 3 months. 3-6 months, Annually, More than 1 year.

The Board of Directors have adopted BR Policy in Feb 2018 and BR Performance of the Company is reviewed by VCMD/BR heads annually.

- Does the Company publish a BR or a Sustainability Report? What is the hyperlink for viewing this report? How frequently it is published?

This is the fourth Business Responsibility Report which forms part of the Company's annual report for the financial year 2020-21. The annual report containing this Business Responsibility Report will be put up on the web site of the Company at www.trivenigroup.com.

SECTION E: PRINCIPLE-WISE PERFORMANCE

Principle 1: Ethics, Transparency and Accountability

The Company's commitment to ethical and lawful business conduct is a fundamental shared value of the Board of Directors, the senior management and all employees of the Company. The corporate governance philosophy of the Company is anchored on the values of integrity, transparency, building efficient and sustainable environment, system and practices to ensure accountability, transparency, fairness in all the transactions in the widest sense to meet stakeholders and societal expectations. The Code of Conduct and other policies adopted by the Company apply to the employees of the Company. In addition, the Company has a Whistle Blower Policy through which the Company seeks to provide a mechanism to the employees and directors to disclose

any unethical and/or improper practice(s) suspected to be taking place in the Company for appropriate action and reporting. Further, no employee is denied access to the Audit Committee and all disclosures are reported to the Chairman of the Audit Committee. The Code of Conduct and Whistle Blower Policy are uploaded on the Company's website- www.trivenigroup.com.

- Does the Policy relating to ethics, bribery and corruption cover only the Company? Does it extend to the Group / Joint Ventures / Suppliers/ Contractors / NGOs/ Others?

The policies, philosophy and thinking in respect of the above issues are practiced by the Company in the normal conduct of the business and it also encourages its suppliers and contractors to adopt such practices. While the subsidiary companies engaged in tangible business activities will follow such policies of the Company, the associate companies in India do practice their own well-structured policies on the same lines.

- How many stakeholders' complaints have been received in the past financial year and what percentage was satisfactorily resolved by the management? If so, provide details thereof.

Stakeholder	Complaints received During 2020-21	Complaints resolved during 2020-21	%age resolved
Investors' Complaints	5	5	100%
Customers' Complaints	200	200	100%
Total	205	205	100%

Principle 2: Sustainability of Products & Services across Life –Cycle

1. List up to 3 of your products or services whose design has incorporated social or environmental concerns, risks and / or opportunities

Most of the products manufactured or dealt with by the Company are environmental friendly:

- Through its cogeneration plants or incidental cogeneration facilities set up in the Sugar manufacturing units, the Company produces power mostly from captive generation of bagasse (a by-product produced during manufacture of sugar from sugarcane), which is a renewable source of energy.
- The distilleries of the Company use captive generated molasses (a by-product produced during manufacture of sugar from sugarcane) to manufacture environment friendly Ethanol (in substitution of fossil fuels) which is used by the Oil Marketing Companies to blend with petrol as per the mandate of the Government. The Company uses effective systems and equipment not only to reduce effluents but has installed & operates incineration boilers along with complete related systems to ensure Zero Liquid Discharge (ZLD) in both the distilleries.
- In the aftermath of Covid 19, there was a huge demand of hand sanitizers, which were in short supply. The Company set up hand sanitizer producing facility at its distillery at Muzaffarnagar in a short span to meet the emergency.
- The Water business of the Company is engaged in offering solution to the industries and municipalities in the area of waste water, sewage and effluents treatment which has the impact of preserving much precious water and reduce pollution and contamination.
- High speed gears manufactured by the Company inter-alia are used to operate steam turbines based on various renewable energy sources, such as, biomass, agricultural waste, waste heat recovery etc. The Company also supplies gearboxes for hydel applications and also for wind gear components, both of which are used for renewable energy generation.

2. For each such product provide the following details in respect of resource use (energy, water, raw material etc.) per unit of product (Optional).

a) Reduction during sourcing / production / distribution achieved since the previous year throughout the value chain? b) Reduction during usage by consumers (energy, water) has been achieved since the previous year?

- The Company is continually engaged in energy conservation (please refer to Annexure-F of the Director's Report) with a view to optimize the resource use.
- In respect of Sugar operations, each of the by-product produced during the manufacture of sugar is majorly captively used to generate power, produce Ethanol or used as organic manure for the benefit of farmers. The conversion of by-products into environmentally beneficial products is made through advanced energy efficient equipment.
- The Company has been focusing on enhancing raw material productivity in sugar operations by propagating appropriate sugarcane varieties which provide higher yield to the farmers and thus, augmenting their income and higher sugar recoveries which help the Company to lower its raw material costs per unit of output produced.
- During the crushing season 2020-21, the Company has achieved comparable recovery of 11.86% as against 11.97% in the previous season and raw material cost per unit of sugar produced has increased by 1 %. There was a general trend of lower yields and recoveries this season as compared to the previous season in Uttar Pradesh but the Company has fared much better than the average decline in the State.

3. Does the Company have procedures in place for sustainable sourcing (including transportation)? If yes, what percentage of your inputs was sourced sustainably?

Yes. The Company deploys procurement practices and procedures for sustainable sourcing based on the requirements of different businesses pursued by the Company.

- The Sugarcane which is the raw material required for the manufacture of sugar is sourced from the farmers and the Company deals with over 300000 farmers in respect of its seven sugar units. About

51% of the total requirement of sugarcane is supplied by the farmers at the sugar mill's gate and the balance about 49% is supplied at the cane centers which are up to 100 km from the sugar mills. There are about 576 cane centers operated by our seven sugar mills. To avoid staling of cane, the Company employs an extensive and efficient arrangements as well as logistics services to transport cane from cane centers to the mill in a timely and cost effective manner.

- Cogeneration plants are set up at the sugar mills and they seamlessly get supply of bagasse, which is produced during manufacture of sugar, mostly through the conveyer belts.
- In respect of Distilleries, the main raw material (molasses) is sourced from our own sugar mills located adjacent (to the distillery) through pipelines or transported through tankers for those which are located at a separate distant location.. The reliability of transport arrangement is ensured for uninterrupted operation of the distilleries.
- Water Business is engaged in project execution at the customer's site. Most of the supplies are engineered-to-order and are outsourced to approved vendors who are entrusted to transport the material directly to the project site after appropriate factory inspection. There is a structured mechanism to develop vendors and to maintain a list of approved vendors for various machineries/ components required in project execution. In some cases, recommended list of vendors is provided by customers.
- The Power Transmission Business has an active domestic and global supply chain for various raw material / components. Based on the criticality and vendor ratings, orders are placed on reliable vendors. The selection of vendor is based on their past performance, reliability, adherence to delivery timelines, cost competitiveness, compliance to laws, including the standards set up by the Company towards EHS, quality of products / services and willingness to reduce costs / wastages and increase productivity as a supply chain partner.

4. Has the Company taken any steps to procure goods and services from local and small producers, including communities surrounding their place of work? If yes, what steps have been taken to improve their capacity and capability of local and small vendors?

The Company procures sugarcane from over 3,00,000 farmers for its seven sugar mills in the state of Uttar Pradesh who are generally located in an area adjoining/ in proximity of the sugar mill. As a part of the cane development programme, the Company partners with these farmers on an ongoing basis to improve sowing, cultivation, crop protection and harvesting techniques in a mutually beneficial manner. The sugar business of the Company has been able to substantially change the sugarcane varietal balance in partnership with farmers which has resulted in increase in recoveries and yields and has immensely helped both the farmers and the Company.

The Company also encourages SMEs, especially in the vicinity of the manufacturing plants, to supply their products and services to the Company and imparts training to them to improve their technical skills.

5. Does the Company have a mechanism to recycle products and waste? If yes, what is the percentage of recycling of products and waste (separately as <5%, 5-10%, >10%). Also, provide details thereof, in about 50 words or so.

In respect of the Sugar Business, the Company has a policy to enhance recycling and reduce effluent quantum and has installed / operates an effective system to treat the industrial effluents and it regularly monitors the efficacy of ETP. Further, it has installed well engineered Bag Filters/ESPs/Wet Scrubbers in its boilers to limit air pollution. All the by-products generated during manufacture of sugar are used to produce environment friendly products of commercial value. The Company has effective systems for the treatment & recycle of the water to conserve its utilization.

Additionally, other waste products include used lubricants, machinery oil and manufacturing scrap which are disposed of to be recycled for further use.

Principle 3: Employee Well-being

Sl. No.	Category	Response
1.	Total number of employees	6524 as on March 31, 2021 (includes Permanent, Temporary, trainee and contractual employees)
2.	Total numbers of employees hired on temporary / contractual / casual basis	2652 as on March 31, 2021
3.	Total number of permanent women employees	35 as on March 31, 2021
4.	Total number of permanent employees with disabilities	Nil
5.	Do you have employee association that is recognized by management?	Yes
6.	What percentages of your permanent employees are members of this recognized employee association?	Around 29.33%
7.	Please indicate the number of complaints relating to child labour, forced labour, involuntary labour, sexual harassment in the last financial year and pending, as on the end of the financial year:	Nil
8.	What percentage of your under mentioned employees were given safety & skill up-gradation training in the last year?	
	Category	Safety (%) Skill Up-gradation (%)
a.	Permanent employees	90% 60%
b.	Permanent Women Employees	75% 70%
c.	Casual / Temporary / Contractual employees	80% 35%
d.	Employees with disabilities	Nil Nil

Principle 4: Stake Holder Engagement
1. Has the Company mapped its internal and external stakeholders?

Yes, the key stakeholders of the Company are employees, farmers, customers, government authorities, suppliers and shareholders.

2. (a) Out of the above has the Company identified the disadvantaged, vulnerable & marginalized stakeholders?
(b) Are there any special initiative taken by the Company to engage with the disadvantage, vulnerable and marginalized stakeholders. If so, provide details thereof, in about 50 words or so.

The Company treats all the stakeholders important and endeavours to remedy hardships, if any, being suffered by them. Further, the Company realizes that its sugar mills are situated in rural areas and it has responsibility to generate employment and entrepreneurship amongst the locals residing in the vicinity and has encouraged and supported the farmers in upgrading farming techniques to augment their income. It operates and manages schools for the betterment of the local people.

Principle 5: Human Rights
1. Does the policy of the Company on human rights cover only the Company or extend to the Group/ Joint Ventures/ Suppliers/ Contractors/ NGOs/ Others?

While the Company or its subsidiaries do not have a stated policy on human rights, it has been practicing a high respect for human rights as a responsible corporate citizen, without any gender discrimination and exploitation. It believes in providing equal opportunity and to remunerate them in a fair manner commensurate with their skills and competence. The Company ensures conformance to fundamental labour principles including prohibition of child labour, forced labour, freedom of association and protection from discrimination in all its operation.

2. How many stakeholders' complaints have been received in the past financial year and what percent was satisfactorily resolved by the management?

During FY 2020-21, the Company has not received any complaints from any stakeholder pertaining to the human rights.

Principle 6: Protection & Restoration of the Environment**1. Does the Policy related to Principle 6 cover only the Company or extend to the Group/ Joint Ventures/ Suppliers/ Contractors/ NGOs/ Others.**

The Company's Policy on Safety, Health & Environment extend to all its offices, manufacturing locations, its employees and its surrounding places and habitat which could be impacted by its operations. The Company encourages its vendors, suppliers, and contractors and subsidiary company having tangible business activity to follow the Principle envisaged in the Policy.

2. Does the Company have strategies / initiatives to address global environmental issues such as climate change, global warming etc.? (Y/N) If yes, please give hyperlink for webpage etc.

Yes, as a responsible corporate, the Company considers environment issues very seriously. In fact, most of the products manufactured by the Company are environment friendly (manufacture of ethanol for blending with petrol; waste water / sewage / effluent treatment business being pursued by Water Business of the Company) and promote generation of power from renewable energy resources (Cogeneration Plants use bagasse which is a renewable fuel as feedstock for producing power). The Company has associated with Confederation of Indian Industry (CII) and formed a center of excellence "CII Triveni Water Institute" which does extensive research and advise wide ranging interventions to improve the quality of water and restore adequate water tables.

3. Does the Company identify and assess potential environmental risks? (Y/N)

The Company is cognizant of the environment risks and continually evaluates the impact of its manufacturing operations on the environment and endeavours to improve its benchmarks for stringent compliance. Further, all decisions relating to development of new products duly incorporate implications, if any, to the environment. As an example, the Company has during the previous year 2019-20 year installed an incineration boiler at its existing distillery to achieve zero liquid discharge and likewise, the new distillery has also been set up with the same technology.

(a) Does the Company have any Project related to Clean Development Mechanism? If yes, whether any environmental compliance report is filed.

Yes, two of the Cogeneration Plants of the Company at Deoband and Khatauli (Phase I) were registered with UNFCCC under Clean Development Mechanism.

(b) Has the Company undertaken any other initiatives on clean technology, energy efficiency, renewable energy, etc.

The Company generates green power from renewable energy sources and also manufactures green fuel (Ethanol) for blending with petrol. Additionally, the Company is also engaged in segments relating to waste water, sewage and effluent treatment. Apart from the environment friendly products manufactured by the Company, the Company is conscious of its responsibility to conduct its operations in a manner to conserve energy

(c) Are the Emissions/ Waste generated by the Company within the permissible limits given by CPCB/ SPCB for the financial year being reported?

Yes, the emissions / waste generated by the Company are within the permissible limits prescribed by Central Pollution Control Board ("CPCB") / UP State Pollution Control Board / Karnataka State Pollution Control Board ("SPCB").

(d) Number of show cause / legal notices received from CPCB/ SPCB which are pending (i.e. not resolved to satisfaction) as on end of financial year.

No such notice from CPCB/SPCB is pending at the end of the financial year.

Principle 7: Responsible Advocacy**1. Is your Company a member of any trade and chamber or association? If yes, name only the ones that your business deals with:**

The Company is a member of various trade and chamber associations. The major ones are:

- Confederation of Indian Industry (CII)
- Federation of Indian Chambers of Commerce and Industry (FICCI)
- Indian Sugar Mills Association (ISMA)

2. Have you advocated / lobbied through above associations for the advancement or improvement of public good? Yes/ No; if yes specify the broad areas.

The Company is continuously in touch with various organization, namely, CII, FICCI, ISMA for improvement of various economic and social policies for sustainable growth in the Sugar and Water Industry. The company has also associated with Confederation of Indian Industry

(CII) and formed a center of excellence “CII Triveni Water Institute” which does extensive research and advise wide ranging interventions to improve the quality of water and restore adequate water tables.

Principle 8: Supporting inclusive Growth & Equitable Development

1. Does the Company have specified programs / initiatives/ projects in pursuit of the Policy related to Principle 8? If yes, details thereof.

- The Company deals with over 3,00,000 farmers across all its seven sugar mills relating to the procurement of sugarcane for the manufacture of sugar. The Company engages in meaningful cane development programme which aims to develop improved sowing, cultivation, crop protection and harvesting techniques and to improve quality of crop and land productivity resulting in enhanced income in the hands of farmers. During the FY 2020-21, the Company has purchased cane worth ₹ 2872.38 crore from its farmers.
- All the payments to the farmers are made through banking channels as a result of which they become entitled for crop related banking assistance.
- The Company encourages employment of local people and promotes entrepreneurship amongst them to supply goods or render services to the sugar mills. The technical training and skill upgradation are provided by the Company, if required.
- The Company operates and manages 03 schools in the vicinity of the sugar mills to provide education to the children residing in the vicinity.

2. Are the Programs/ Projects undertaken through in house team / own foundation/ external NGO/ Government structures / any other organisation?

Most of the programmes are undertaken by the In-house team. The specialized services, wherever required, are procured from expert third parties, including through various tie-ups.

3. Have you done any impact assessment of your initiatives?

While it is difficult to quantify, the results are visible through higher income accruing in the hands of farmers due to enhanced yields & cane supply and improved operational performance of the Company in terms of better sugar recovery and increased supply of sugarcane. The mutual cooperation with its farmers will help the Company to meet its social and commercial objectives.

4. What is your Company’s direct contribution to community development projects – amount in INR and the details of the project undertaken?

In addition to CSR activities undertaken, the Company has incurred ₹ 1.87 crore in the cane development activities and financial assistance, as required, is provided to the schools being maintained by the Sugar mills. The time spent in counselling, educating farmers, managing schools and providing other services are administrative and time extensive, and thus, are difficult to be quantified. In addition, the Company has undertaken activities related to installations of tube wells, maintenance of ponds, cleaning of drains, organizing health camps etc through its community development initiatives. The Company also undertook active participation in distribution of hand sanitizers to curb the spread of Covid -19.

5. Have you taken steps to ensure that this community development initiative is successfully adopted by the Community?

The Company believes that if the activities are carried out in a structured manner as per well laid out plan with proper identification of the target segment of the community, it is bound to be received well and adopted by the community. The Company stringently follows this line of thinking and continually monitors community development initiatives through various parameters such as productivity of land, income accruing to farmers, health indicators, literacy levels, sustainable livelihood processes and state of infrastructure among others.

Principle 9: Providing value to Customers and Consumers

1. What percentage of customer complaints / consumer cases are pending as on the end of the financial year.

The Company considers customer satisfaction as an important objective and has a well-structured policy on customer complaints resolution. The Company endeavours to resolve all complaints in an expeditious manner. As on 31.03.2021, there were no complaint pending for resolution.

2. Does the Company display product information on the product label, over and above what is mandated as per local laws?

The Company displays applicable product information as mandated by Bureau of Indian Standards/FSSAI. The Company complies with all the applicable regulations as provided in Legal Metrology Act, Bureau of Indian Standards Specifications, Food Safety and Standards Act and the relevant rules prescribed therein.

- 3. Is there any case filed by any stakeholders against the Company regarding unfair trade practices, irresponsible advertising/ or anti-competitive behaviour during the last five years and pending as on end of financial year. If so, provide details thereof, in about 50 words or so.**

The Company has not indulged in any unfair trade practices, irresponsible advertising or anti-competitive behavior.

There is a pending case of appeal by the distilleries (including our Company) to NCLAT wherein a stay has been granted to the Company upon deposit of 10% of the penalty amount ₹ 174.16 lakhs ordered to be paid by Competition Commission of India (CCI) vide its order dated 18.09.2018 on the charges of collusion in submitting bids by the distilleries against a tender for the procurement of Ethanol.

- 4. Did your Company carry out any consumer survey/ consumer satisfaction trends?**

The Company considers customer satisfaction as one of its foremost objectives and endeavors to take feedback from customers through practical means. In the Engineering Businesses, wherein the number of customers are not very large, the Company takes feedback directly from the customers, including through electronic means. In the Sugar business, such feedback, essentially on quality, is received through sugar agents as it not possible to deal with innumerable final customers.

For and on behalf of the Board of Directors

Dhruv M. Sawhney

Chairman and Managing Director

DIN: 00102999

June 29, 2021

The background is a solid orange color. A large, dark orange brushstroke graphic, resembling a paintbrush stroke, sweeps across the lower half of the page from the bottom left towards the top right. The text is centered in the lower half of the page.

Standalone Financial Statements

Independent Auditor's Report

To
The Members of
Triveni Engineering & Industries Limited

REPORT ON THE AUDIT OF THE STANDALONE FINANCIAL STATEMENTS

Opinion

We have audited the Standalone financial statements of **TRIVENI ENGINEERING & INDUSTRIES LIMITED** ("the Company"), which comprise the Standalone Balance Sheet as at 31 March 2021, and the Standalone Statement of Profit and Loss (including other comprehensive income), Standalone Statement of Changes in Equity and Standalone Statement of Cash Flows for the year then ended, and notes to the Standalone financial statements, including a summary of significant accounting policies and other explanatory information.

In our opinion and to the best of our information and according to the explanations given to us, the aforesaid financial statements give the information required by the Companies Act, 2013 ("the Act") in the manner so required and give a true and fair view in conformity with the accounting principles generally accepted in India, of the state of affairs of the Company as at 31 March 2021, and profit (including other

comprehensive loss), changes in equity and its cash flows for the year ended on that date.

Basis for Opinion

We conducted our audit in accordance with the Standards on Auditing (SAs) specified under section 143(10) of the Act. Our responsibilities under those Standards are further described in the Auditor's Responsibilities for the Audit of the Standalone financial statements section of our report. We are independent of the Company in accordance with the Code of Ethics issued by the Institute of Chartered Accountants of India together with the ethical requirements that are relevant to our audit of the Standalone financial statements under the provisions of the Act and the Rules thereunder, and we have fulfilled our other ethical responsibilities in accordance with these requirements and the Code of Ethics. We believe that the audit evidence we have obtained is sufficient and appropriate to provide a basis for our opinion.

Key Audit Matters

Key audit matters are those matters that, in our professional judgment, were of most significance in our audit of the Standalone financial statements of the current period. These matters were addressed in the context of our audit of the Standalone financial statements as whole, and in forming our opinion thereon, and we do not provide a separate opinion on these matters.

Sr. Key Audit Matters No.	Auditor's Response
<p>1. Recognition of Subsidies:</p> <p>We identified recognition of subsidies as the key audit matter as it involves significant management judgement.</p> <p>The area of management judgement includes management risk assessment with respect to recognition of subsidies based on substantive compliance of the conditions and reasonable certainty of receipt of subsidy.</p> <p>(Refer Note no. 2(a)(iii) & 43 of the standalone financial statements)</p>	<p>Our audit procedures included the following:</p> <ul style="list-style-type: none"> Obtaining policy from the Company defining the management perspective and basis for recognition of Government subsidies in the books of accounts. Obtaining an understanding of internal controls over recognition and recoverability of subsidy claims and testing, on a sample basis, their design, implementation and operating effectiveness. Considered the relevant circulars/notification issued by various authorities. Evaluated the management's assessment regarding the reasonable certainty for complying with the relevant conditions as specified in circulars/notification issued by various authorities.

Sr. Key Audit Matters No.	Auditor's Response
<p>2. Appropriateness of cost to complete the project:</p> <p>The Company recognizes revenue from construction contracts on percentage of completion method as specified in Indian Accounting Standards (Ind AS) 115- Revenue from Contract with Customers. (Refer Accounting policy Note no. 1(b)(iii))</p> <p>We identified this matter as a Key Audit matter as it involves significant judgement by the management in estimation of cost to complete the project and any variation may have consequential impact on revenue.</p>	<p>Our audit procedures included the following:</p> <ul style="list-style-type: none"> • Obtaining an understanding of internal controls over estimation of cost of completion of projects and testing, on a sample basis, their design, implementation and operating effectiveness. • Agreed the total project revenue estimates to contracts with customers. • Obtained computation of estimated costs to complete and the percentage of project completion and verified the same against the contracts on sample basis and also checked arithmetic accuracy of the same. • Performed the walkthrough procedure and verified the invoices, purchase orders etc. for actual cost incurred till the year end. • Compared the management estimates revised during the year with the estimate made in earlier years and obtained reasons/approval for such revision.

Information other than the Standalone financial statements and Auditor's Report thereon

The Company's Board of Directors is responsible for the preparation of the other information. The other information comprises the information included in the annual report, but does not include the Standalone financial statements and our auditor's report thereon.

Our opinion on the Standalone financial statements does not cover the other information and we do not express any form of assurance conclusion thereon.

In connection with our audit of the Standalone financial statements, our responsibility is to read the other information and, in doing so, consider whether the other information is materially inconsistent with the Standalone financial statements or our knowledge obtained during the course of our audit or otherwise appears to be materially misstated.

If, based on the work we have performed, we conclude that there is a material misstatement of this other information, we are required to report that fact. We have nothing to report in this regard.

Management's Responsibility for Standalone Financial Statements

The Company's Board of Directors is responsible for the matters stated in section 134(5) of the Act with respect to the preparation of these Standalone financial statements

that give a true and fair view of the financial position, financial performance, changes in equity and cash flows of the Company in accordance with the accounting principles generally accepted in India, including the Indian accounting Standards (Ind AS) specified under section 133 of the Act. This responsibility also includes maintenance of adequate accounting records in accordance with the provisions of the Act for safeguarding of the assets of the Company and for preventing and detecting frauds and other irregularities; selection and application of appropriate accounting policies; making judgments and estimates that are reasonable and prudent; and design, implementation and maintenance of adequate internal financial controls, that were operating effectively for ensuring the accuracy and completeness of the accounting records, relevant to the preparation and presentation of the Standalone financial statements that give a true and fair view and are free from material misstatement, whether due to fraud or error.

In preparing the Standalone financial statements, management is responsible for assessing the Company's ability to continue as a going concern, disclosing, as applicable, matters related to going concern and using the going concern basis of accounting unless management either intends to liquidate the Company or to cease operations, or has no realistic alternative but to do so.

Those Board of Directors are also responsible for overseeing the company's financial reporting process.

Auditor's Responsibilities for the Audit of the Standalone Financial Statements

Our objectives are to obtain reasonable assurance about whether the Standalone financial statements as a whole are free from material misstatement, whether due to fraud or error, and to issue an auditor's report that includes our opinion. Reasonable assurance is a high level of assurance, but is not a guarantee that an audit conducted in accordance with SAs will always detect a material misstatement when it exists. Misstatements can arise from fraud or error and are considered material if, individually or in the aggregate, they could reasonably be expected to influence the economic decisions of users taken on the basis of these Standalone financial statements.

As part of an audit in accordance with SAs, we exercise professional judgment and maintain professional scepticism throughout the audit. We also:

- Identify and assess the risks of material misstatement of the Standalone financial statements, whether due to fraud or error, design and perform audit procedures responsive to those risks, and obtain audit evidence that is sufficient and appropriate to provide a basis for our opinion. The risk of not detecting a material misstatement resulting from fraud is higher than for one resulting from error, as fraud may involve collusion, forgery, intentional omissions, misrepresentations, or the override of internal control.
- Obtain an understanding of internal control relevant to the audit in order to design audit procedures that are appropriate in the circumstances. Under section 143(3) (i) of the Act, we are also responsible for expressing our opinion on whether the company has adequate internal financial controls system in place and the operating effectiveness of such controls.
- Evaluate the appropriateness of accounting policies used and the reasonableness of accounting estimates and related disclosures made by management.
- Conclude on the appropriateness of management's use of the going concern basis of accounting and, based on the audit evidence obtained, whether a material uncertainty exists related to events or conditions that may cast significant doubt on the Company's ability to continue as a going concern. If we conclude that a material uncertainty exists, we are required to draw attention in our auditor's report to the related disclosures in the Standalone financial statements or, if such disclosures are inadequate, to modify our opinion. Our conclusions are based on the audit evidence obtained

up to the date of our auditor's report. However, future events or conditions may cause the Company to cease to continue as a going concern.

- Evaluate the overall presentation, structure and content of the Standalone financial statements, including the disclosures, and whether the Standalone financial statements represent the underlying transactions and events in a manner that achieves fair presentation.

Materiality is the magnitude of misstatements in the Standalone financial statements that, individually or in aggregate, makes it probable that the economic decisions of a reasonably knowledgeable user of the financial statements may be influenced. We consider quantitative materiality and qualitative factors in (i) planning the scope of our audit work and in evaluating the results of our work; and (ii) to evaluate the effect of any identified misstatements in the Standalone financial statements.

We communicate with those charged with governance regarding, among other matters, the planned scope and timing of the audit and significant audit findings, including any significant deficiencies in internal control that we identify during our audit.

We also provide those charged with governance with a statement that we have complied with relevant ethical requirements regarding independence, and to communicate with them all relationships and other matters that may reasonably be thought to bear on our independence, and where applicable, related safeguards.

From the matters communicated with those charged with governance, we determine those matters that were of most significance in the audit of the Standalone financial statements of the current period and are therefore the key audit matters. We describe these matters in our auditor's report unless law or regulation precludes public disclosure about the matter or when, in extremely rare circumstances, we determine that a matter should not be communicated in our report because the adverse consequences of doing so would reasonably be expected to outweigh the public interest benefits of such communication.

Report on Other Legal and Regulatory Requirements

1. As required by the Companies (Auditor's Report) Order, 2016 ("the Order"), issued by the Central Government of India in terms of sub-section (11) of section 143 of the Act, we give in the "Annexure A" a statement on the matters specified in paragraphs 3 and 4 of the Order, to the extent applicable.

2. As required by section 143(3) of the Act, we report that:
- a) We have sought and obtained all the information and explanations which to the best of our knowledge and belief were necessary for the purposes of our audit.
 - b) In our opinion, proper books of account as required by law have been kept by the Company so far as it appears from our examination of those books.
 - c) The Standalone Balance Sheet, the Standalone Statement of Profit and Loss (including Other Comprehensive Income), Standalone Statement of Changes in Equity and the Standalone Statement of Cash Flows dealt with by this Report are in agreement with the books of account.
 - d) In our opinion, the aforesaid Standalone financial statements comply with the Indian Accounting Standards (Ind AS) specified under section 133 of the Act.
 - e) On the basis of the written representations received from the directors as on 31 March 2021 taken on record by the Board of Directors, none of the directors is disqualified as on 31 March 2021 from being appointed as a director in terms of section 164 (2) of the Act.
 - f) With respect to the adequacy of the internal financial controls with reference to financial statements of the Company and the operating effectiveness of such controls, refer to our separate Report in "Annexure B".
 - g) With respect to the other matters to be included in the Auditor's Report in accordance with

the requirements of section 197(16) of the Act, as amended:

In our opinion and to the best of our information and according to the explanations given to us, the remuneration paid by the Company to its directors during the year is in accordance with the provisions of section 197 of the Act.

- h) With respect to the other matters to be included in the Auditor's Report in accordance with Rule 11 of the Companies (Audit and Auditors) Rules, 2014, in our opinion and to the best of our information and according to the explanations given to us:
 - i. The Company has disclosed the impact of pending litigations as at 31 March 2021 on its financial position in its Standalone financial statements – Refer Note no. 46 to the Standalone financial statements.
 - ii. The Company has made provision, as required under the applicable law or accounting standards, for material foreseeable losses, on long-term contracts including long term derivative contracts.
 - iii. There were no amounts which were required to be transferred to the Investor Education and Protection Fund by the Company.

For **S S Kothari Mehta & Company**
Chartered Accountants
Firm Registration No. 000756N

Yogesh K. Gupta
Partner

Place: Faridabad (Haryana)
Date: June 29, 2021

Membership No.:093214
UDIN: 21093214AAAAFB6761

Annexure A” to the Independent Auditors’ Report

The Annexure **as referred in paragraph (1) ‘Report on Other Legal and Regulatory Requirements** of our Independent Auditors’ Report to the members of **TRIVENI ENGINEERING & INDUSTRIES LIMITED** on the standalone financial statements for the year ended 31 March 2021, we report that:

- i. (a) The Company has generally maintained proper records showing full particulars including quantitative details and situation of fixed assets.
 - (b) The Company has a regular program of physical verification of its fixed assets which in our opinion, is reasonable having regard to the size of the Company and the nature of its fixed assets. In accordance with this program, all major items of fixed assets were physically verified by the management during the year and no material discrepancies were noticed on such verification as compared to the books of accounts.
 - (c) According to the information and explanation given to us and on the basis of examination of title deeds / sale deeds / transfer deeds / conveyance deeds / possession letters / allotment letters and other relevant records evidencing title/ possession provided and legal opinion obtained by the Company, we report that the title deeds of the immovable properties are held in the name of the Company as at the balance sheet date except for 3 cases having gross book value of ₹ 13.13 lakhs in respect of freehold land as disclosed in Note no. 3 on Property, Plant & Equipment to the Standalone financial statements, where the title deeds are not held in the name of the Company.
- ii. The physical verification of the inventory has been conducted at reasonable intervals by the management during the year. As far as we could ascertain and according to information and explanations given to us, no material discrepancies were noticed between the physical stock and the book records.
 - iii. According to the information and explanations given to us, the Company has granted loans to two bodies corporate, covered in the register maintained under section 189 of the Companies Act, 2013, in respect of which:

- (a) In our opinion, the rate of interest and other terms and conditions on which the loans had been granted to bodies corporate covered in the register maintained under section 189 of the Act were not, prima facie, prejudicial to the interest of the Company.

- (b) In respect of aforesaid loans, repayment of principal and payment of interest has been stipulated in the agreements entered with the respective bodies corporate.

In respect of one of the loans, principal is not due for repayment and payment of interest has been regular as per stipulations.

While in the other case of an Associate Company, Aqwise Wise Water Technologies Ltd., principal including interest amounting to ₹ 302.01 lacs which was rolled over as a fresh loan on similar stipulation during the previous/current year was due for repayment on March 25, 2021. This loan along with interest thereon has been agreed to be converted into equity shares based on Share Purchase Agreement entered with the buyer dated March 25, 2021 and is shown as “assets held for sale” (Refer note no.13 to the standalone financial statements).

Further, in respect of same Associate Company (Aqwise Wise Water Technologies Ltd.), new loan was given during the year in respect of which principal including interest amounting to ₹ 1831.47 lacs which was due for repayment as on March 25, 2021, was received subsequent to the balance sheet date.

- (c) There is no overdue amount for more than 90 days in respect of above-mentioned loans.

- iv. According to the information and explanations given to us and on the basis of our examination of the records, the Company has not granted any loans or provided any guarantees or securities to parties which are covered under section 185 of the Act. The Company has complied with the provisions of section 186 of the Act in respect of grant of loans, making investments and providing guarantees and securities, as applicable.

- v. According to the information and explanations given to us, the Company has not accepted any deposits from the public within the meaning of sections 73 to 76 of the Companies Act, 2013 and the rules framed there under. Accordingly, the provisions of clause 3 (v) of the Order are not applicable to the Company.
- vi. We have broadly reviewed the books of account maintained by the Company pursuant to the rules prescribed by the Central Government of India for the maintenance of cost records under sub-section 1 of section 148 of the Companies Act, 2013 and are of the opinion that, prima facie, the prescribed records and accounts have been made and maintained. However, we have not carried out a detailed examination of such records with a view to determining whether they are accurate or complete.
- vii. (a) According to the information and explanations given to us and on the basis of examination of the records of the Company, the Company is generally regular in depositing undisputed statutory dues including provident fund, employees' state insurance, sales-tax, income tax, service tax, customs duty, excise duty, value added tax, goods and services tax and other material statutory dues with the appropriate authorities to the extent applicable.
- (b) According to the information and explanations given to us and on the basis of examination of the records of the Company there are no undisputed aforesaid statutory dues payable as at 31 March 2021 for a period of more than six months from the date they became payable.
- (c) According to the records and information and explanations given to us, there are no dues in respect of income tax, sales tax, service tax, goods and services tax, excise duty, customs duty, or value added tax which have not been deposited on account of any dispute except as given below:

Name of Statute	Nature of Dues	Period (F.Y.) to which the amount relates	Amount Demanded (Excluding interest) (₹ in Lakhs)	Amount paid (₹ in Lakhs)	Forum where dispute is pending
The Central Excise Act, 1944	Excise Duty	1998 to 2004-05, 2006-07, 2009-10 to 2013-14	116.11	13.82	High Court
The Central Excise Act, 1944	Penalty	2002-03 to 2004-05	269.30	266.00	High Court
The Central Excise Act, 1944	Excise Duty	1995-96 to 1996-97,	1.61	1.61	Custom, Excise and Service Tax Appellate Tribunal
The Central Excise Act, 1944	Penalty	1995-96 to 1996-97,	0.07	0.07	Custom, Excise and Service Tax Appellate Tribunal
The Central Excise Act, 1944	Excise Duty	2015-16	25.01	1.88	Commissioner (Appeal)
The Custom Act, 1962	Penalty	2004-05	19.93	6.19	Custom, Excise and Service Tax Appellate Tribunal
The Custom Act, 1962	Penalty	2019-20	2.00	2.00	Commissioner (Appeal)
Central Sales Tax Act, 1956 & State VAT Act	Sales Tax	1993-94 & 2010-11 to 2011-12	59.92	1.82	High Court
Central Sales Tax Act, 1956 & State VAT Act	Sales Tax	2013-14 & 2014-15	255.64	56.03	Tribunal
Central Sales Tax Act, 1956 & State VAT Act	Sales Tax	2013-14 to 2017-18 (Q1)	334.73	26.01	Addl/ Joint Commissioner
Central Sales Tax Act, 1956 & State VAT Act	Penalty	2013-14 to 2017-18 (Q1)	16.21	-	Addl/ Joint Commissioner
The UP Sugarcane (Purchase Tax) Act, 1961	Purchase Tax	2016-17 to 2017-18 (Q1)	476.61	-	High Court

Name of Statute	Nature of Dues	Period (F.Y.) to which the amount relates	Amount Demanded (Excluding interest) (₹ in Lakhs)	Amount paid (₹ in Lakhs)	Forum where dispute is pending
Orissa Sales Tax Act, 1947	Sales Tax	1991-95	9.21	2.00	Assistant Commissioner Sales Tax Range 2 Cuttack Orissa
Orissa Sales Tax Act, 1947	Sales Tax	1987-88	0.44	0.32	Sales Tax Tribunal- Orissa Cuttack
The Income Tax Act, 1961	Income Tax	2005-06, 2007-08 & 2010-11	2636.20	922.41	Income Tax Appellate Tribunal
The Income Tax Act, 1961	Income Tax	2004-05, 2005-06 & 2019-20	197.81	154.95	CIT(A)

- viii. In our opinion, on the basis of audit procedures and according to the information and explanations given to us, the Company has not defaulted in repayment of loans or borrowings to any banks, financial institutions or government during the year. The Company has not issued any debentures.
- ix. According to the information and explanations given to us, the Company has not raised moneys by way of initial public offer or further public offer (including debt instruments) during the year. The term loans have been applied for the purpose for which they were raised.
- x. During the course of our examination of the books and records of the Company carried out in accordance with the generally accepted auditing practices in India, we have neither come across any instance of fraud by the Company or on the Company by its officers or employees being noticed or reported during the year, nor have we been informed of such case by the management.
- xi. According to the information and explanations given to us and based on our examination of the records of the Company, the Company has paid/ provided for managerial remuneration in accordance with the requisite approvals mandated by the provisions of section 197 read with Schedule V to the Companies Act, 2013.
- xii. In our opinion and according to the information and explanations given to us, the Company is not a Nidhi Company. Accordingly, clause 3(xii) of the Order is not applicable.
- xiii. According to the information and explanations given to us and based on our examination of the records of the

Company, transactions with the related parties are in compliance with section 177 and 188 of the Companies Act, 2013, where applicable, and details of such transactions have been disclosed in the Standalone financial statements as required under Indian Accounting Standard (Ind AS) 24, Related Party Disclosures specified under section 133 of the Companies Act, 2013.

- xiv. According to the information and explanations given to us and based on our examination of the records of the Company, the Company has not made any preferential allotment or private placement of shares or fully or partly convertible debentures during the year. Accordingly, clause 3(xiv) of the Order is not applicable.
- xv. According to the information and explanations given to us and based on our examination of the records of the Company, the Company has not entered into non-cash transactions with directors or persons connected with him. Accordingly, clause 3(xv) of the Order is not applicable.
- xvi. The Company is not required to be registered under section 45-IA of the Reserve Bank of India Act, 1934. Accordingly, clause 3(xvi) of the Order is not applicable.

For **S S Kothari Mehta & Company**

Chartered Accountants
Firm Registration No. 000756N

Yogesh K. Gupta

Partner

Place: Faridabad (Haryana)

Date: June 29, 2021

Membership No.:093214

UDIN: 21093214AAAFAFB6761

“Annexure B” to the Independent Auditor’s Report of even date on the Standalone Financial Statements of TRIVENI ENGINEERING & INDUSTRIES LIMITED

REPORT ON THE INTERNAL FINANCIAL CONTROLS UNDER CLAUSE (I) OF SUB-SECTION 3 OF SECTION 143 OF THE COMPANIES ACT, 2013 (“THE ACT”) AS REFERRED TO IN PARAGRAPH 2(F) OF ‘REPORT ON OTHER LEGAL AND REGULATORY REQUIREMENTS’

We have audited the internal financial controls over financial reporting of **TRIVENI ENGINEERING & INDUSTRIES LIMITED** (“the Company”) as of 31 March 2021 in conjunction with our audit of the Standalone financial statements of the Company for the year ended on that date.

MANAGEMENT’S RESPONSIBILITY FOR INTERNAL FINANCIAL CONTROLS

The Company’s management is responsible for establishing and maintaining internal financial controls based on the internal controls with reference to financial statements criteria established by the Company considering the essential components of internal control stated in the Guidance Note on Audit of Internal Financial Controls over Financial Reporting issued by the Institute of Chartered Accountants of India. These responsibilities include the design, implementation and maintenance of adequate internal financial controls that were operating effectively for ensuring the orderly and efficient conduct of its business, including adherence to company’s policies, the safeguarding of its assets, the prevention and detection of frauds and errors, the accuracy and completeness of the accounting records, and the timely preparation of reliable financial information, as required under the Companies Act, 2013.

AUDITORS’ RESPONSIBILITY

Our responsibility is to express an opinion on the Company’s internal financial controls with reference to financial statements based on our audit. We conducted our audit in accordance with the Guidance Note on Audit of Internal Financial Controls Over Financial Reporting (the “Guidance Note”) issued by the Institute of Chartered Accountants of India and the Standards on Auditing, prescribed under section 143(10) of the Companies Act, 2013, to the extent applicable to an audit of internal financial controls. Those Standards and the Guidance Note require that we comply with ethical requirements and plan and perform the audit to obtain reasonable assurance about whether adequate internal financial controls with reference to financial statements was established and maintained and if such controls operated effectively in all material respects.

Our audit involves performing procedures to obtain audit evidence about the adequacy of the internal financial

controls system with reference to financial statements and their operating effectiveness. Our audit of internal financial controls with reference to financial statements included obtaining an understanding of internal financial controls with reference to financial statements, assessing the risk that a material weakness exists, and testing and evaluating the design and operating effectiveness of internal control based on the assessed risk. The procedures selected depend on the auditor’s judgement, including the assessment of the risks of material misstatement of the financial statements, whether due to fraud or error.

We believe that the audit evidence we have obtained is sufficient and appropriate to provide a basis for our audit opinion on the Company’s internal financial controls system with reference to financial statements of the Company.

MEANING OF INTERNAL FINANCIAL CONTROLS WITH REFERENCE TO FINANCIAL STATEMENTS

A company’s internal financial control with reference to financial statements is a process designed to provide reasonable assurance regarding the reliability of financial reporting and the preparation of financial statements for external purposes in accordance with generally accepted accounting principles. A company’s internal financial control with reference to financial statements includes those policies and procedures that (1) pertain to the maintenance of records that, in reasonable detail, accurately and fairly reflect the transactions and dispositions of the assets of the company; (2) provide reasonable assurance that transactions are recorded as necessary to permit preparation of financial statements in accordance with generally accepted accounting principles, and that receipts and expenditures of the company are being made only in accordance with authorisations of management and directors of the company; and (3) provide reasonable assurance regarding prevention or timely detection of unauthorised acquisition, use, or disposition of the company’s assets that could have a material effect on the financial statements.

INHERENT LIMITATIONS OF INTERNAL FINANCIAL CONTROLS WITH REFERENCE TO FINANCIAL STATEMENTS

Because of the inherent limitations of internal financial controls with reference to financial statements, including the possibility of collusion or improper management override of controls, material misstatements due to error or fraud may occur and not be detected. Also, projections of any evaluation

of the internal financial controls with reference to financial statements to future periods are subject to the risk that the internal financial control with reference to financial statements may become inadequate because of changes in conditions, or that the degree of compliance with the policies or procedures may deteriorate.

OPINION

In our opinion, the Company has, in all material respects, an adequate internal financial controls system with reference to financial statements and such internal financial controls with reference to financial statements were operating effectively as at 31 March 2021, based on the internal control over financial

reporting criteria established by the Company considering the essential components of internal control stated in the Guidance Note on Audit of Internal Financial Controls Over Financial Reporting issued by the Institute of Chartered Accountants of India.

For **S S Kothari Mehta & Company**

Chartered Accountants
Firm Registration No. 000756N

Yogesh K. Gupta

Partner

Place: Faridabad (Haryana)

Date: June 29, 2021

Membership No.:093214

UDIN: 21093214AAAAFB6761

Standalone Balance Sheet

as at March 31, 2021

(All amounts in ₹ lakhs, unless otherwise stated)

	Note No.	As at 31-Mar-21	As at 31-Mar-20
ASSETS			
Non-current assets			
Property, plant and equipment	3	105898.21	107393.34
Capital work-in-progress	3	2223.43	2615.84
Investment property	4	442.04	538.58
Intangible assets	5	123.68	93.12
Financial assets			
i. Investments	6	4852.60	7310.83
ii. Trade receivables	7	125.84	29.73
iii. Loans	8	2002.46	1511.82
iv. Other financial assets	9	1396.68	917.92
Income tax assets (net)	22	1117.58	4336.79
Other non-current assets	10	2113.46	700.51
Total non-current assets		120295.98	125448.48
Current assets			
Inventories	11	173374.92	191212.69
Financial assets			
i. Trade receivables	7	21937.06	29501.79
ii. Cash and cash equivalents	12 (a)	992.41	3058.30
iii. Bank balances other than cash and cash equivalents	12 (b)	75.70	80.85
iv. Loans	8	1843.77	337.96
v. Other financial assets	9	294.42	208.08
Other current assets	10	25946.63	43751.14
		224464.91	268150.81
Assets held for sale	13	988.34	3.05
Total current assets		225453.25	268153.86
Total assets		345749.23	393602.34
EQUITY AND LIABILITIES			
Equity			
Equity share capital	14	2417.57	2479.47
Other equity	15	143906.15	124585.87
Total equity		146323.72	127065.34
LIABILITIES			
Non-current liabilities			
Financial liabilities			
i. Borrowings	16	26068.26	44359.64
ii. Other financial liabilities	17	972.68	1221.63
Provisions	18	5175.34	4793.34
Deferred tax liabilities (net)	23	10084.54	4949.03
Other non-current liabilities	19	962.60	1821.52
Total non-current liabilities		43263.42	57145.16
Current liabilities			
Financial liabilities			
i. Borrowings	20	56157.43	94343.87
ii. Trade payables	21		
(a) total outstanding dues of micro enterprises and small enterprises		538.57	6.73
(b) total outstanding dues of creditors other than micro enterprises and small enterprises		61874.41	75633.30
iii. Other financial liabilities	17	15540.24	20079.20
Other current liabilities	19	16426.13	15355.95
Provisions	18	3727.66	3182.95
Income tax liabilities (net)	22	1897.65	789.84
Total current liabilities		156162.09	209391.84
Total liabilities		199425.51	266537.00
Total equity and liabilities		345749.23	393602.34

The accompanying notes 1 to 50 form an integral part of these standalone financial statements

As per our report of even date attached

For S S Kothari Mehta & Company
Chartered Accountants

Firm's registration number : 000756N

Yogesh K. Gupta

Partner

Membership No. 093214

For and on behalf of the Board of Directors of Triveni Engineering & Industries Limited
Dhruv M. Sawhney

Chairman & Managing Director

Suresh Taneja

Group CFO

Homai A. Daruwalla

Director & Chairperson Audit Committee

Geeta Bhalla

Group Vice President & Company Secretary

Date : June 29, 2021

Standalone Statement of Profit and Loss

for the year ended March 31, 2021

(All amounts in ₹ lakhs, unless otherwise stated)

	Note No.	Year ended 31-Mar-21	Year ended 31-Mar-20
Revenue from operations	24	469320.49	442357.18
Other income	25	3430.15	4006.70
Total income		472750.64	446363.88
Expenses			
Cost of materials consumed	26	321491.82	301067.82
Purchases of stock-in-trade	27	2200.73	2229.42
Changes in inventories of finished goods, stock-in-trade and work-in-progress	28	19914.26	21882.64
Excise duty on sale of goods		2917.60	-
Employee benefits expense	29	27005.90	25497.80
Finance costs	30	5143.70	7931.70
Depreciation and amortisation expense	31	7908.76	7489.12
Impairment loss on financial assets (including reversals of impairment losses)	32	384.71	861.47
Other expenses	33	40412.89	37541.42
Total expenses		427380.37	404501.39
Profit before exceptional items and tax		45370.27	41862.49
Exceptional items	34	(2183.14)	282.04
Profit before tax		43187.13	42144.53
Tax expense:			
- Current tax	35	10705.26	7633.98
- Deferred tax	35	5151.01	1762.03
Total tax expense		15856.27	9396.01
Profit for the year		27330.86	32748.52
Other comprehensive income			
A (i) Items that will not be reclassified to profit or loss			
- Remeasurements of the defined benefit plan	38	(44.36)	(147.86)
		(44.36)	(147.86)
A (ii) Income tax relating to items that will not be reclassified to profit or loss	35	(15.50)	(51.67)
		(28.86)	(96.19)
B (i) Items that may be reclassified to profit or loss		-	-
B (ii) Income tax relating to items that may be reclassified to profit or loss	35	-	-
		(28.86)	(96.19)
Other comprehensive income for the year, net of tax		(28.86)	(96.19)
Total comprehensive income for the year		27302.00	32652.33
Earnings per equity share (face value ₹ 1 each)			
Basic	36	11.14	13.01
Diluted	36	11.14	13.01

The accompanying notes 1 to 50 form an integral part of these standalone financial statements

As per our report of even date attached

For S S Kothari Mehta & Company
Chartered Accountants

Firm's registration number : 000756N

Yogesh K. Gupta

Partner

Membership No. 093214

Date : June 29, 2021

For and on behalf of the Board of Directors of Triveni Engineering & Industries Limited

Dhruv M. Sawhney

Chairman & Managing Director

Suresh Taneja

Group CFO

Homai A. Daruwalla

Director & Chairperson Audit Committee

Geeta Bhalla

Group Vice President & Company Secretary

Standalone Statement of Changes in Equity

for the year ended March 31, 2021

(All amounts in ₹ lakhs, unless otherwise stated)

	Reserves and surplus					Total other equity
	Capital redemption reserve	Capital reserve	Securities premium	Amalgamation reserve	General reserve	
As at 31 March 2019	397.40	2855.85	26546.93	926.34	49212.72	105249.33
Equity shares of ₹ 1 each issued, subscribed and fully paid up (including paid up value of ₹ 0.02 lakhs pertaining to forfeited shares)	-	-	-	-	-	2579.47
As at 31 March 2020	-	-	-	-	-	(100.00)
Extinguishment of shares upon buy-back [refer note 14 (iv)]	-	-	-	-	-	2479.47
As at 31 March 2021	-	-	-	-	-	(61.90)
Extinguishment of shares upon buy-back [refer note 14 (iv)]	-	-	-	-	-	2417.57
As at 31 March 2021	-	-	-	-	-	2417.57
B. OTHER EQUITY						
Balance as at 31 March 2019						
Profit for the year	-	-	-	-	-	25093.73
Other comprehensive income, net of income tax	-	-	-	-	-	32748.52
Total comprehensive income for the year	-	-	-	-	-	(96.19)
Transferred to molasses storage fund reserve	-	-	-	-	-	32652.33
Withdrawal from molasses storage fund reserve	-	-	-	-	-	(21.60)
Transactions with owners in their capacity as owners:						
- Amount utilised for buy-back of equity shares [refer note 14(iv)]	-	-	-	-	-	(97.25)
- Transferred from securities premium to capital redemption reserve on buy-back of equity shares [refer note 14(iv)]	100.00	-	-	-	-	97.25
- Transaction costs related to buy-back of equity shares [refer note 14(iv)]	-	-	-	-	-	(127.76)
- Dividends paid [refer note 14(iv)]	-	-	-	-	-	(2727.40)
- Dividend distribution tax	-	-	-	-	-	(560.63)
Balance as at 31 March 2020						
Profit for the year	497.40	2855.85	16419.17	926.34	49212.72	124585.87
Other comprehensive income, net of income tax	-	-	-	-	-	27330.86
Total comprehensive income for the year	-	-	-	-	-	(28.86)
Transferred from retained earnings to molasses storage fund reserve	-	-	-	-	-	40.49
Transactions with owners in their capacity as owners:						
- Amount utilised for buy-back of equity shares [refer note 14(iv)]	-	-	-	-	-	(6437.60)
- Transferred from securities premium to capital redemption reserve on buy-back of equity shares [refer note 14(iv)]	61.90	-	-	-	-	(61.90)
- Transaction costs related to buy-back of equity shares [refer note 14(iv)]	-	-	-	-	-	(87.68)
- Tax paid on buy-back of equity shares [refer note 14(iv)]	-	-	-	-	-	(1456.44)
Balance as at 31 March 2021						
	559.30	2855.85	8375.55	926.34	49212.72	143906.15

The accompanying notes 1 to 50 form an integral part of these standalone financial statements

As per our report of even date attached

For S S Kothari Mehta & Company
Chartered Accountants

Firm's registration number : 000756N

Yogesh K. Gupta

Partner

Membership No. 093214

Date : June 29, 2021

For and on behalf of the Board of Directors of Triveni Engineering & Industries Limited
Dhruv M. Sawhney

Chairman & Managing Director

Suresh Taneja

Group CFO

Homai A. Daruwalla

Director & Chairperson Audit Committee

Geeta Bhalla

Group Vice President & Company Secretary

Standalone Statement of Cash Flows

for the year ended March 31, 2021

(All amounts in ₹ lakhs, unless otherwise stated)

	Year ended 31-Mar-21	Year ended 31-Mar-20
Cash flows from operating activities		
Profit before tax	43187.13	42144.53
Adjustments for :		
Depreciation and amortisation expense	7908.76	7489.12
Bad debts written off - trade receivables carried at amortised cost	75.06	315.06
Impairment loss allowance on trade receivables and other financial assets (net of reversals)	309.65	546.41
Bad debts written off - non financial assets	10.00	17.36
Impairment loss allowance on non financial assets (net of reversals)	59.24	(8.65)
Provision for non moving/obsolete inventory (net of reversals)	(6.00)	(74.29)
Loss on sale/write off of inventory	15.77	200.44
Net fair value (gains)/losses on investments	(169.36)	61.77
Mark-to-market losses/(gains) on derivatives	(35.92)	2.19
Credit balances written back	(131.63)	(208.16)
Exceptional items - Net impairment loss allowance on investments in equity shares (including loan agreed to be converted into equity)	2319.87	-
Exceptional items - profit on disposal of investment property	(136.73)	(282.04)
Unrealised losses/(gains) from changes in foreign exchange rates	25.38	(19.69)
Loss on sale/write off/impairment of property, plant and equipment	423.49	19.86
Net (profit)/loss on sale/redemption of investments	(0.02)	(0.10)
Interest income	(957.55)	(253.30)
Dividend income	(2.84)	(356.00)
Finance costs	5143.70	7931.70
Working capital adjustments :		
Change in inventories	17828.01	20527.06
Change in trade receivables	7101.39	(6597.20)
Change in other financial assets	(41.31)	(1.29)
Change in other assets	17755.73	(24600.10)
Change in trade payables	(13126.43)	12067.08
Change in other financial liabilities	356.61	105.30
Change in other liabilities	1367.75	2033.74
Change in provisions	882.34	277.59
Cash generated from operations	90162.09	61338.39
Income tax paid (net)	(6033.61)	(7075.51)
Net cash inflow from operating activities	84128.48	54262.88
Cash flows from investing activities		
Purchase of property, plant and equipment and intangible assets	(8924.48)	(11691.61)
Proceeds from sale of property, plant and equipment	237.47	87.73
Advance given against purchase of investments	-	(160.00)
Advance received against assets held for sale	-	10.00
Investments in subsidiaries	(224.00)	(1990.00)
Investments (other than subsidiaries and associates)	(5.27)	-
Proceeds from sale of investment property	226.32	561.55
Proceeds from disposal/redemption of investments (other than subsidiaries and associates)	10.69	20.72
Loan to subsidiaries and associates	(3753.60)	(1430.00)
Repayments of loan by subsidiaries and associates	1530.00	-
Decrease/(increase) in deposits with banks	(437.16)	24.79
Interest received	490.93	205.79
Dividend received	2.84	356.00
Net cash outflow from investing activities	(10846.26)	(14005.03)

Standalone Statement of Cash Flows (Contd.)

for the year ended March 31, 2021

(All amounts in ₹ lakhs, unless otherwise stated)

	Year ended 31-Mar-21	Year ended 31-Mar-20
Cash flows from financing activities		
Proceeds from long term borrowings	593.09	21354.87
Repayment of long term borrowings	(23856.23)	(8932.63)
Increase/(decrease) in short term borrowings	(38186.44)	(29197.08)
Interest paid (other than on lease liabilities)	(5141.15)	(7728.18)
Payment of lease liabilities (interest portion)	(146.14)	(180.75)
Payment of lease liabilities (principal portion)	(567.62)	(467.59)
Buy-back of equity shares	(6499.50)	(10000.00)
Buy-back costs	(87.68)	(127.76)
Tax paid on buy-back of equity shares	(1456.44)	-
Dividend paid to Company's shareholders	-	(2727.40)
Dividend distribution tax	-	(560.63)
Net cash outflow from financing activities	(75348.11)	(38567.15)
Net increase/(decrease) in cash and cash equivalents	(2065.89)	1690.70
Cash and cash equivalents at the beginning of the year [refer note 12 (a)]	3058.30	1367.60
Cash and cash equivalents at the end of the year [refer note 12 (a)]	992.41	3058.30

Reconciliation of liabilities arising from financing activities:

	Non-current borrowings (including current maturities and deferred grant related to borrowings)	Current borrowings	Interest payable (other than on lease liabilities)	Lease liabilities	Buy-back of equity shares (including tax thereon and buy- back costs)	Dividend paid to Company's shareholders (including DDT)
Balance as at 31 March 2019	49049.44	123540.95	169.69	-	-	-
Cash flows	12422.24	(29197.08)	(7728.18)	(648.34)	(10127.76)	(3288.03)
Finance costs accruals (including interest capitalised)	-	-	7795.97	185.93	-	-
Lease liabilities accruals	-	-	-	2228.91	-	-
Buy-back of equity shares (including tax thereon and buy-back costs) accruals	-	-	-	-	10127.76	-
Dividend distributions (including DDT) accruals	-	-	-	-	-	3288.03
Balance as at 31 March 2020	61471.68	94343.87	237.48	1766.50	-	-
Cash flows	(23263.14)	(38186.44)	(5141.15)	(713.76)	(8043.62)	-
Finance costs accruals (including interest capitalised)	-	-	4997.08	147.12	-	-
Lease liabilities accruals	-	-	-	125.67	-	-
Buy-back of equity shares (including tax thereon and buy-back costs) accruals	-	-	-	-	8043.62	-
Balance as at 31 March 2021	38208.54	56157.43	93.41	1325.53	-	-

The accompanying notes 1 to 50 form an integral part of these standalone financial statements

As per our report of even date attached

For S S Kothari Mehta & Company
Chartered Accountants

Firm's registration number : 000756N

Yogesh K. Gupta

Partner

Membership No. 093214

For and on behalf of the Board of Directors of Triveni Engineering & Industries Limited
Dhruv M. Sawhney

Chairman & Managing Director

Suresh Taneja

Group CFO

Homai A. Daruwalla

Director & Chairperson Audit Committee

Geeta Bhalla

Group Vice President & Company Secretary

Date : June 29, 2021

Notes to the Standalone Financial Statements

for the year ended March 31, 2021

(All amounts in ₹ lakhs, unless otherwise stated)

CORPORATE INFORMATION

Triveni Engineering & Industries Limited ("the Company") is a company limited by shares, incorporated and domiciled in India. The Company's equity shares are listed at two recognised stock exchanges in India (BSE and NSE). The registered office of the Company is located at Deoband, Distt. Saharanpur, Uttar Pradesh – 247554. The Company is engaged in diversified businesses, mainly categorised into two segments – Sugar & allied businesses and Engineering business. Sugar & allied businesses primarily comprises manufacture of sugar and distillation of alcohol. Engineering business primarily comprises manufacture of high speed gears, gearboxes and providing water/waste-water treatment solutions.

NOTE 1: SIGNIFICANT ACCOUNTING POLICIES

This note provides a list of the significant accounting policies adopted in the preparation of these financial statements. These policies have been consistently applied to all the years presented, unless otherwise stated.

(a) Basis of preparation and presentation

(i) Compliance with Ind AS

The financial statements comply in all material aspects with Indian Accounting Standards (Ind AS) notified under Section 133 of the Companies Act, 2013 (the Act) [Companies (Indian Accounting Standards) Rules, 2015 (as amended)] and other relevant provisions of the Act.

(ii) Historical cost convention

The financial statements have been prepared on an accrual basis under historical cost convention except for certain assets and liabilities that are measured at fair values at the end of each reporting period, as explained in the respective accounting policies described in subsequent paragraphs.

Historical cost is generally based on the fair value of the consideration given in exchange for goods and services.

Fair value is the price that would be received to sell an asset or paid to transfer a liability in an orderly transaction between market participants at the measurement date, regardless of whether that price is directly observable or estimated using another valuation technique. In estimating the fair

value of an asset or a liability, the Company takes into account the characteristics of the asset or liability if market participants would take those characteristics into account when pricing the asset or liability at the measurement date. Fair value for measurement and/or disclosure purposes in these financial statements is determined on such a basis, except for leasing transactions that are within the scope of Ind AS 116 Leases (see note 1(d)), and measurements that have some similarities to fair value but are not fair value, such as net realisable value in Ind AS 2 Inventories (see note 1(l)) or value in use in Ind AS 36 *Impairment of Assets* (see note 1(f)).

(iii) Classification of assets and liabilities into current/non-current

All assets and liabilities have been classified as current or non-current as per the Company's normal operating cycle and other criteria set out in Schedule III to the Act. The operating cycle of the Company is the time between the acquisition of assets for processing and their realisation in cash or cash equivalents.

(b) Revenue recognition

Revenue from contracts with customers is recognised when control of the goods or services are transferred to the customer at an amount that reflects the consideration to which the Company expects to be entitled in exchange for those goods or services. Transaction price at which revenue is recognised is net of goods & services tax and amounts collected on behalf of third parties, if any and includes effect of variable consideration (viz. returns, rebates, trade allowances, credits, penalties etc.). Variable consideration is estimated using the expected value method or most likely amount as appropriate in a given circumstance and is included in the transaction price only to the extent it is highly probable that a significant revenue reversal in the amount of cumulative revenue recognised will not occur when the associated uncertainty with the variable consideration is subsequently resolved.

Recognising revenue from major business activities

(i) Sale of goods

Revenue from the sale of goods is recognised at the point in time when control of the goods are

Notes to the Standalone Financial Statements

for the year ended March 31, 2021

(All amounts in ₹ lakhs, unless otherwise stated)

transferred to the customer (i.e. satisfaction of performance obligation), generally on dispatch of the goods. The Company, in its engineering business, generally provides warranties to its customers in the nature of assurance, which is considered as an obligation and provided for under Ind AS 37 Provisions, Contingent Liabilities and Contingent Assets (refer note 1(n)).

(ii) Rendering of services

The Company provides engineering services that are either sold separately or bundled together with the sale of goods to a customer.

Contracts for bundled sales of goods and engineering services are comprised of two performance obligations because the promises to transfer goods and provide engineering services are distinct and capable of being separately identifiable. Accordingly, the Company allocates the transaction price based on relative stand-alone selling prices of such goods and engineering services.

The Company recognises revenue from engineering services over time, using an input method to measure progress towards complete satisfaction of the service, because the customer simultaneously receives and consumes the benefits provided by the Company. The progress towards complete satisfaction of the service is determined as follows:

- erection & commissioning / servicing revenue - based on technical estimate of completion of physical proportion of the contract work;
- operation & maintenance revenue - as the proportion of the total period of services contract that has elapsed at the end of the reporting period

(iii) Construction contracts

Construction contracts are analysed to determine combination of contracts and identification of performance obligations and accordingly transaction price is allocated amongst performance obligations based on stand-alone selling prices. Performance obligations, in construction contracts, generally includes construction/ turnkey related

activities and operation & maintenance related activities which are satisfied over time with the customer receiving benefits from the activities being performed by the Company.

When the progress towards complete satisfaction of performance obligations of a construction contract can be estimated reliably, revenue is recognised by reference to the stage of completion of the contract activity at the end of the reporting period, measured based on the proportion of contract costs incurred for work performed to date relative to the estimated total contract costs, because the customer simultaneously receives and consumes the benefits provided by the Company. Contract costs excludes costs that do not depict the Company's progress in satisfying the performance obligation.

When the outcome of performance obligations of a construction contract cannot be estimated reliably, but the Company expects to recover the costs incurred in satisfying the performance obligation, contract revenue is recognised only to the extent of the contract costs incurred until such time that it can reasonably measure the outcome of the performance obligation. Contract costs are recognised as expenses in the period in which they are incurred.

(iv) Dividend income

Dividend income from investments is recognised when the Company's right to receive payment has been established.

(v) Interest income

Interest income is accrued on a time basis, by reference to the principal outstanding and at the effective interest rate applicable, which is the rate that exactly discounts estimated future cash receipts through the expected life of the financial asset to that asset's net carrying amount on initial recognition.

(c) Government grants

Grants from the government are recognised where there is a reasonable assurance that the Company will comply with all attached conditions and the grant shall be received.

Notes to the Standalone Financial Statements

for the year ended March 31, 2021

(All amounts in ₹ lakhs, unless otherwise stated)

Government grants relating to income are deferred and recognised in the profit or loss over the period necessary to match them with the costs that they are intended to compensate and presented either within other operating income/other income or net of related costs.

Government grants relating to the purchase of property, plant and equipment are deducted from its gross value and are recognised in profit or loss on a systematic and rational basis over the expected useful lives of the related assets by way of reduced depreciation.

Government grants that are receivable as compensation for expenses or losses already incurred or for the purpose of giving immediate financial support to the Company with no future related costs are recognised in profit or loss in the period in which they become receivable.

The Government grants by way of a benefit of a Government loan at a below market rate of interest is measured as the difference between proceeds received and the fair value of the loan based on prevailing market interest rates.

See note 43 for disclosures and treatment of government grants in financial statements.

(d) Leases

(i) As a lessee

The Company's lease assets classes primarily consist of leases for land and buildings. The Company assesses whether a contract contains a lease, at inception of a contract. A contract is, or contains, a lease if the contract conveys the right to control the use of an identified asset for a period of time in exchange for consideration. To assess whether a contract conveys the right to control the use of an identified asset, the Company assesses whether: (i) the contract involves the use of an identified asset; (ii) the Company has substantially all of the economic benefits from use of the asset through the period of the lease; and (iii) the Company has the right to direct the use of the asset.

At the date of commencement of the lease, the Company recognises a right-of-use ("ROU") assets and a corresponding lease liability for all lease arrangements in which it is a lessee, except for

leases with a term of twelve months or less (short-term leases) and low value leases. The ROU assets are initially recognised at cost, which comprises the initial amount of the lease liability adjusted for any lease payments made at or prior to the commencement date of the lease plus any initial direct costs less any lease incentives. They are subsequently measured at cost less accumulated depreciation and impairment losses. ROU assets are depreciated from the commencement date on a straight-line basis over the shorter of the lease term and useful life of the underlying asset (see note 1(i) below) and is also evaluated for impairment (see note 1(f) below). The lease liability is measured at amortised cost at the present value of the future lease payments. The lease term includes (a) the non-cancellable period of the lease; (b) the period covered by an option to extend the lease, if it is reasonably certain that such option shall be exercised; and (c) the period covered by an option to terminate the lease, if it is reasonably certain that such option shall not be exercised. Lease liabilities are remeasured with a corresponding adjustment to the related ROU assets if the Company changes its assessment concerning the right to exercise its option of extending or terminating the lease provided to it under the relevant arrangement.

For short-term and low value leases as mentioned above, the Company recognises the lease payments as an operating expense on a straight-line basis over the term of the lease.

(ii) As a lessor

Leases are classified as finance leases whenever the terms of the lease transfer substantially all the risks and rewards of ownership to the lessee. All other leases are classified as operating leases. The Company has given certain portion of its office / factory premises under operating leases (refer note 44). Lease income from operating leases is recognised as income on a straight-line basis over the lease term. Initial direct costs incurred in negotiating and arranging an operating lease are added to the carrying amount of the leased asset and recognised on a straight-line basis over the lease term. Respective leased assets are included in the balance sheet based on their nature.

Notes to the Standalone Financial Statements

for the year ended March 31, 2021

(All amounts in ₹ lakhs, unless otherwise stated)

(e) Foreign currency translation

(i) Functional and presentation currency

The financial statements are presented in Indian rupee (₹), which is the Company's functional and presentation currency unless stated otherwise.

(ii) Transactions and balances

Foreign currency transactions are translated into the functional currency using the exchange rates that approximates the actual rate at the date of respective transactions. Foreign exchange gains or losses resulting from the settlement of such transactions and from the translation of monetary assets and liabilities denominated in foreign currencies at year end exchange rates are recognised in profit or loss in the period in which they arise except for foreign exchange gains or losses on settlement or translation of foreign currency borrowings that are directly attributable to acquisition, construction or production of a qualifying asset, which are included in cost of those assets when they are regarded as an adjustment to interest costs on those foreign currency borrowings.

Foreign exchange gains or losses which are regarded as an adjustment to borrowing costs are presented in the statement of profit and loss, within finance costs. All other foreign exchange gains and losses are presented in the statement of profit and loss on a net basis within other income or other expenses, as the case may be.

(f) Impairment of non-financial assets

Non-financial assets are tested for impairment whenever events or changes in circumstances indicate that the carrying amount may not be recoverable. An impairment loss is recognised for the amount by which the asset's carrying amount exceeds its recoverable amount. The recoverable amount is the higher of an asset's fair value less costs of disposal and value in use. In assessing value in use, the estimated future cash flows are discounted to their present value using a discount rate that reflects current market assessments of the time value of money and the risks specific to the asset. In determining fair value less costs of disposal, recent market transactions are taken into account. If no such transactions can be identified, an appropriate valuation model is used.

For the purposes of assessing impairment, assets are grouped at the lowest levels for which there are separately identifiable cash inflows which are largely independent of the cash inflows from other assets or groups of assets (cash-generating units). Non-financial assets that suffered an impairment are reviewed for possible reversal of the impairment at the end of each reporting period. When an impairment loss subsequently reverses, the carrying amount of the asset is increased to the revised estimate of its recoverable amount, so however that the increased carrying amount does not exceed the carrying amount that would have been determined had no impairment loss been recognised for the asset in prior years. A reversal of an impairment loss is recognised immediately in profit or loss.

(g) Borrowing costs

Borrowing costs directly attributable to the acquisition, construction or production of a qualifying asset are capitalised during the period of time that is required to complete and prepare the asset for its intended use or sale. Borrowing costs are not capitalised during extended periods in which active development of qualifying assets is suspended. Qualifying assets are assets that necessarily take a substantial period of time to get ready for their intended use or sale.

Other borrowing costs are expensed in the period in which they are incurred.

(h) Income tax

Income tax expense represents the sum of the tax currently payable and deferred tax.

(i) Current tax

The tax currently payable is based on taxable profit for the year. Taxable profit differs from 'profit before tax' as reported in the statement of profit and loss because of items of income or expense that are taxable or deductible in other years and items that are never taxable or deductible. The Company's current tax is calculated using tax rates that have been enacted or substantively enacted by the end of the reporting period.

(ii) Deferred tax

Deferred tax is recognised on temporary differences between the carrying amounts of assets and

Notes to the Standalone Financial Statements

for the year ended March 31, 2021

(All amounts in ₹ lakhs, unless otherwise stated)

liabilities in the financial statements and the corresponding tax bases used in the computation of taxable profit. Deferred tax liabilities are generally recognised for all taxable temporary differences. Deferred tax assets are generally recognised for all deductible temporary differences, the carry forward of unused tax credits and unused tax losses to the extent that it is probable that taxable profits will be available against which those deductible temporary differences, the carry forward of unused tax credits and unused tax losses can be utilised. Such deferred tax assets and liabilities are not recognised if the temporary difference arises from the initial recognition (other than in a business combination) of assets and liabilities in a transaction that affects neither the taxable profit nor the accounting profit. In addition, deferred tax liabilities are not recognised if the temporary difference arises from the initial recognition of goodwill.

The carrying amount of deferred tax assets is reviewed at the end of each reporting period and reduced to the extent that it is no longer probable that sufficient taxable profits will be available to allow all or part of the asset to be recovered.

Deferred tax liabilities and assets are measured at the tax rates that are expected to apply in the period in which the liability is settled or the asset realised, based on tax rates (and tax laws) that have been enacted or substantively enacted by the end of the reporting period.

The measurement of deferred tax liabilities and assets reflects the tax consequences that would follow from the manner in which the Company expects, at the end of the reporting period, to recover or settle the carrying amount of its assets and liabilities.

(iii) Current and deferred tax for the year

Current and deferred tax are recognised in profit or loss, except when they relate to items that are recognised in other comprehensive income or directly in equity, in which case, the current and deferred tax are also recognised in other comprehensive income or directly in equity respectively. Where current tax or deferred tax

arises from the initial accounting for a business combination, the tax effect is included in the accounting for the business combination.

(i) Property, plant and equipment

Property, plant and equipment are tangible items that are held for use in the production or supply of goods and services, rental to others or for administrative purposes and are expected to be used during more than one period. The cost of an item of property, plant and equipment is recognised as an asset if and only if it is probable that future economic benefits associated with the item will flow to the Company and the cost of the item can be measured reliably. Freehold land is carried at cost. All other items of property, plant and equipment are stated at cost less accumulated depreciation and accumulated impairment losses, if any. Cost comprises purchase price after deducting trade discounts/rebates, government grants related to assets and including import duties and non-refundable purchase taxes, borrowing costs, any costs that is directly attributable to the bringing the asset to the location and condition necessary for it to be capable of operating in the manner intended by the management and costs of dismantling/removing the item and restoring the site on which it was located under an obligation. Subsequent costs are included in the asset's carrying amount or recognised as a separate asset, as appropriate, only when it is probable that future economic benefits associated with the item will flow to the Company and the cost of the item can be measured reliably.

Each part of item of property, plant and equipment, if significant in relation to the total cost of the item, is depreciated separately. Further, parts of plant and equipment that are technically advised to be replaced at prescribed intervals/period of operation, insurance spares and cost of inspection/overhauling are depreciated separately based on their specific useful life provided these are of significant amounts commensurate with the size of the Company and scale of its operations. The carrying amount of any equipment/inspection/overhauling accounted for as separate asset is derecognised when replaced. All other repairs and maintenance costs are charged to profit or loss during the reporting period in which they are incurred.

Notes to the Standalone Financial Statements

for the year ended March 31, 2021

(All amounts in ₹ lakhs, unless otherwise stated)

An item of property, plant and equipment is derecognised upon disposal or when no future economic benefits are expected to arise from the continued use of the asset. Any gain or loss arising on the disposal or retirement of an item of property, plant and equipment is determined as the difference between the sales proceeds and the carrying amount of the asset and is recognised in profit or loss.

Transition to Ind AS

On transition to Ind AS, the Company has elected to continue with the carrying value of all of its property, plant and equipment recognised as at 1 April 2015 (transition date) measured as per the previous GAAP and use that carrying value as the deemed cost of the property, plant and equipment.

Depreciation methods, estimated useful lives and residual value

Depreciation commences when the assets are available for their intended use. Depreciation is calculated using the straight-line method to allocate their cost, net of their residual values, over their estimated useful lives.

The management has estimated the useful lives and residual values of all property, plant and equipment and adopted useful lives as stated in Schedule II along with residual values of 5% except for the following:

- On the basis of technical assessment and past experience:
 - the useful lives of mill rollers, instrumentation and control devices installed at sugar plants is considered at ten years as against prescribed life of twenty five years in respect of continuous process plant.
 - mobile phones costing ₹ 5,000/- or more are depreciated over two years.
 - patterns, tools, Jigs etc. are depreciated over three years.
 - machinery spares are depreciated over a life ranging from five to ten years.
- Assets costing less than ₹ 5,000/- are fully depreciated in the year of purchase.

Estimated useful lives considered are as follows:

Assets	Estimated useful life
Buildings	3 - 60 years
Roads	3 - 10 years
Plant & equipment	3 - 25 years
Furniture & fixtures	10 years
Vehicles	8 - 10 years
Office equipment	2 - 5 years
Computers	3 - 6 years
Laboratory equipment	10 years
Electrical installations and equipment	10 years

Fixture and fittings and improvements to leasehold buildings not owned by the Company are amortised over the unexpired lease period or estimated useful life of such fixture, fittings and improvements, whichever is lower.

The estimated useful lives, residual values and depreciation method are reviewed at the end of each reporting period, with the effect of any changes in estimate accounted for on a prospective basis.

(i) Investment property

Property that is held for long-term rental yields or for capital appreciation or both, is classified as investment property. Investment property is stated at cost less accumulated depreciation and accumulated impairment losses, if any. Investment property is measured initially at its cost, including related transaction costs and, where applicable, borrowing costs. Cost comprises purchase price after deducting trade discounts/rebates, government grants related to assets and including duties and taxes, borrowing costs, any costs that is directly attributable to the bringing the asset to the location and condition necessary for it to be capable of operating in the manner intended by management and costs of dismantling/removing the item and restoring the site on which it was located under an obligation. Subsequent expenditure is capitalised to the asset's carrying amount only when it is probable that future economic benefits associated with the expenditure will flow to the Company and the cost of the item can be measured reliably. All other repairs and maintenance costs are expensed when incurred.

Notes to the Standalone Financial Statements

for the year ended March 31, 2021

(All amounts in ₹ lakhs, unless otherwise stated)

An investment property is derecognised upon disposal or when the investment property is permanently withdrawn from use and no future economic benefits are expected from the disposal. Any gain or loss arising on derecognition of the property (calculated as the difference between the net disposal proceeds and the carrying amount of the asset) is included in profit or loss in the period in which the property is derecognised.

Investment property being building is depreciated using the straight-line method over their estimated useful lives as stated in Schedule II at 30 years along with residual values of 5%.

Transition to Ind AS

On transition to Ind AS, the Company has elected to continue with the carrying value of all of its investment properties recognised as at 1 April 2015 (transition date) measured as per the previous GAAP and use that carrying value as the deemed cost of investment properties.

(k) Intangible assets

Intangible assets are carried at cost less accumulated amortisation and accumulated impairment losses, if any. Costs comprises purchase price after deducting trade discounts/rebates, government grants related to assets and including import duties and non-refundable purchase taxes, borrowing costs and any directly attributable cost of preparing the asset for its intended use. Subsequent costs are included in the asset's carrying amount or recognised as a separate asset, as appropriate, only when it is probable that future economic benefits associated with the item will flow to the Company and the cost of the item can be measured reliably. Intangible assets being computer software is amortised using straight-line method over estimated useful life of 3 years. The estimated useful life and amortisation method are reviewed at the end of each reporting period, with the effect of any changes in estimate being accounted for on a prospective basis.

An intangible asset is derecognised on disposal, or when no future economic benefits are expected from use or disposal. Gains or losses arising from derecognition of an intangible asset, measured as the difference between the net disposal proceeds and the carrying amount of the asset, is recognised in profit or loss when the asset is derecognised.

Transition to Ind AS

On transition to Ind AS, the Company has elected to continue with the carrying value of all of intangible assets recognised as at 1 April 2015 measured as per the previous GAAP and use that carrying value as the deemed cost of intangible assets.

(l) Inventories

(i) Finished goods and work-in-progress are valued at lower of cost and net realisable value. The cost of finished goods and work-in-progress is computed on weighted average basis and includes raw material costs, direct cost of conversion and proportionate allocation of indirect costs incurred in bringing the inventories to their present location and condition. Finished goods and work-in-progress are written down if their net realisable value declines below the carrying amount of the inventories and such write downs of inventories are recognised in profit or loss. When reasons for such write downs ceases to exist, the write downs are reversed through profit or loss.

(ii) Inventories of raw materials & components, stores & spares and stock-in-trade are valued at lower of cost and net realisable value. Raw materials and other items held for use in the production of inventories are not written down below cost if the finished goods in which they will be incorporated are expected to be sold at or above cost. Write down of such inventories are recognised in profit or loss and when reasons for such write downs ceases to exist, such write downs are reversed through profit or loss. Cost of such inventories comprises of purchase price and other directly attributable costs that have been incurred in bringing the inventories to their present location and condition. By-products used as raw material are valued at transfer price linked with net realisable value. Cost for the purpose of valuation of raw materials & components, stores & spares and stock-in-trade is considered on the following basis :

Raw materials & Components

Business Units	Basis
Sugar	First in first out
Co-generation & Distillery	Weighted average
Water Business Group	Specific cost
Power Transmission Business	Weighted average and Specific cost

Notes to the Standalone Financial Statements

for the year ended March 31, 2021

(All amounts in ₹ lakhs, unless otherwise stated)

Stores & Spares

Business Units	Basis
Water Business Group	Specific cost
Other units	Weighted average

Stock-in-trade

Business Units	Basis
Branded goods trading business	Weighted average
Diesel/petrol retailing business	First in first out

- (iii) By-products (excluding those used as raw materials) and scrap are valued at estimated net realisable value.

(m) Non-current assets held for sale

Non-current assets are classified as held for sale if their carrying amount will be recovered principally through a sale transaction rather than through continuing use. This condition is regarded as met only when the asset is available for immediate sale in its present condition subject only to terms that are usual and customary for sales of such asset and its sale is highly probable. They are measured at the lower of their carrying amount and fair value less costs to sell. Non-current assets once classified as held for sale are neither depreciated nor amortised.

(n) Provisions, contingent liabilities and contingent assets

- (i) Provisions are recognised when the Company has a present obligation (legal or constructive) as a result of a past event, it is probable that the Company will be required to settle the obligation, and a reliable estimate can be made of the amount of the obligation. The amount recognised as a provision is the best estimate of the consideration required to settle the present obligation at the end of the reporting period, taking into account the risks and uncertainties surrounding the obligation. When the effect of the time value of money is material, provision is measured at the present value of cash flows estimated to settle the present obligation. When some or all of the economic benefits required

to settle a provision are expected to be recovered from a third party, a receivable is recognised as an asset if it is virtually certain that reimbursement will be received and the amount of the receivable can be measured reliably.

- (ii) A contingent liability is not recognised in the financial statements, however, is disclosed, unless the possibility of an outflow of resources embodying economic benefits is remote. If it becomes probable that an outflow of future economic benefits will be required for an item dealt with as a contingent liability, a provision is recognised in the financial statements of the period (except in the extremely rare circumstances where no reliable estimate can be made).
- (iii) A contingent asset is not recognised in the financial statements, however, is disclosed, where an inflow of economic benefits is probable. When the realisation of income is virtually certain, then the asset is no longer a contingent asset, and is recognised as an asset.
- (iv) Provisions, contingent liabilities and contingent assets are reviewed at each balance sheet date.

(o) Employee benefits

(i) Short-term obligations

Liabilities for wages and salaries, including non-monetary benefits that are expected to be settled wholly within twelve months after the end of the period in which the employees render the related service are recognised in respect of employees' services up to the end of the reporting period and are measured at the undiscounted amounts expected to be paid when the liabilities are settled. The liabilities are presented as current benefit obligations in the balance sheet.

(ii) Other long-term employee benefit obligations

Other long-term employee benefits include earned leaves and sick leaves. The liabilities for earned leaves and sick leaves are not expected to be settled wholly within twelve months after the end of the period in which the employees render the related service. They are therefore measured at the present value of expected future payments to be made in respect of services provided by

Notes to the Standalone Financial Statements

for the year ended March 31, 2021

(All amounts in ₹ lakhs, unless otherwise stated)

employees up to the end of the reporting period using the projected unit credit method, with actuarial valuations being carried out at the end of each annual reporting period. The benefits are discounted using the market yield on government bonds at the end of the reporting period that have maturity term approximating to the estimated term of the related obligation. Remeasurements as a result of experience adjustments and changes in actuarial assumptions are recognised in profit or loss. The obligations are presented as provisions in the balance sheet.

(iii) Post-employment obligations

The Company operates the following post-employment schemes:

- defined benefit plans towards payment of gratuity; and
- defined contribution plans towards employees' provident fund & employee pension scheme, employees' state insurance, superannuation scheme and national pension scheme.

Defined benefit plan

The Company provides for gratuity obligations through a defined benefit retirement plan (the 'Gratuity Plan') covering all employees. The Gratuity Plan provides a lump sum payment to vested employees at retirement/termination of employment or death of an employee, based on the respective employees' salary and years of employment with the Company.

The liability or asset recognised in the balance sheet in respect of the defined benefit plan is the present value of the defined benefit obligation at the end of the reporting period less the fair value of plan assets. The present value of the defined benefit obligation is determined using projected unit credit method by discounting the estimated future cash outflows with reference to market yield at the end of the reporting period on government bonds that have maturity terms approximating the estimated term of the related obligation, through actuarial valuations carried out at the end of each annual reporting period.

The net interest cost is calculated by applying the discount rate to the net balance of the defined benefit obligation and the fair value of plan assets. Such net interest cost along with the current service cost and, if applicable, the past service cost and settlement gain/loss, is included in employee benefit expense in the statement of profit and loss. Remeasurement gains and losses arising from experience adjustments and changes in actuarial assumptions, comprising actuarial gains/losses and return on plan assets (excluding the amount recognised in net interest on the net defined liability), are recognised in the period in which they occur, directly in other comprehensive income. They are included in retained earnings in the statement of changes in equity and in the balance sheet.

Defined contribution plans

Defined contribution plans are retirement benefit plans under which the Company pays fixed contributions to separate entities (funds) or financial institutions or state managed benefit schemes. The Company has no further payment obligations once the contributions have been paid. The defined contributions plans are recognised as employee benefit expense when they are due. Prepaid contributions are recognised as an asset to the extent that a cash refund or a reduction in the future payments is available.

■ Provident Fund Plan & Employee Pension Scheme

The Company makes monthly contributions at prescribed rates towards Employees' Provident Fund/ Employees' Pension Scheme to a Fund administered and managed by the Government of India.

■ Employee State Insurance

The Company makes prescribed monthly contributions towards Employees' State Insurance Scheme.

■ Superannuation Scheme

The Company contributes towards a fund established to provide superannuation benefit to certain employees in terms of Group Superannuation Policy entered into by

Notes to the Standalone Financial Statements

for the year ended March 31, 2021

(All amounts in ₹ lakhs, unless otherwise stated)

such fund with the Life Insurance Corporation of India.

■ National Pension Scheme

The Company makes contributions to the National Pension Scheme fund in respect of certain employees of the Company.

(p) Dividends

Provision is made for the amount of any dividend declared, being appropriately authorised and no longer at the discretion of the Company, on or before the end of the reporting period but not distributed by the end of the reporting period.

(q) Financial assets

(i) Classification

The Company classifies its financial assets in the following measurement categories:

- those to be measured subsequently at fair value (either through other comprehensive income, or through profit or loss), and
- those measured at amortised cost.

The classification depends on the Company's business model for managing the financial assets and the contractual terms of the cash flows.

For assets measured at fair value, gains and losses will either be recorded in profit or loss or other comprehensive income. For assets in the nature of debt instruments, this will depend on the business model. For assets in the nature of equity instruments, this will depend on whether the Company has made an irrevocable election at the time of initial recognition to account for the equity instrument at fair value through other comprehensive income.

The Company reclassifies debt instruments when and only when its business model for managing those assets changes.

(ii) Measurement

At initial recognition, the Company measures a financial asset at its fair value plus, in the case of a financial asset not at fair value through profit or loss, transaction costs that are directly attributable to the acquisition of the financial asset. Transaction costs

of financial assets carried at fair value through profit or loss are expensed in profit or loss.

Debt instruments

Subsequent measurement of debt instruments depends on the Company's business model for managing the asset and the cash flow characteristics of the asset. There are three measurement categories into which the Company classifies its debt instruments:

- Amortised cost: Assets that are held for collection of contractual cash flows where those cash flows represent solely payments of principal and interest are measured at amortised cost. A gain or loss on a debt investment that is subsequently measured at amortised cost is recognised in profit or loss when the asset is derecognised or impaired. Interest income from these financial assets is recognised using the effective interest rate method.
- Fair value through other comprehensive income (FVTOCI): Assets that are held for collection of contractual cash flows and for selling the financial assets, where the assets' cash flows represent solely payments of principal and interest, are measured at FVTOCI. Movements in the carrying amount are taken through OCI, except for the recognition of impairment gains or losses, interest income and foreign exchange gains and losses which are recognised in profit or loss. When the financial asset is derecognised, the cumulative gain or loss previously recognised in OCI is reclassified from equity to profit or loss and recognised in other gains/(losses). Interest income from these financial assets is included in other income using the effective interest rate method.
- Fair value through profit or loss (FVTPL): Assets that do not meet the criteria for amortised cost or FVTOCI are measured at fair value through profit or loss. A gain or loss on a debt investment that is subsequently measured at fair value through profit or loss is recognised in profit or loss and presented net in the statement of profit and loss within other gains/(losses) in the period in which it arises.

Notes to the Standalone Financial Statements

for the year ended March 31, 2021

(All amounts in ₹ lakhs, unless otherwise stated)

Interest income from these financial assets is included in other income.

Equity instruments

The Company subsequently measures all equity investments at fair value, except for equity investments in subsidiaries and associates where the Company has the option to either measure it at cost or fair value. The Company has opted to measure equity investments in subsidiaries and associates at cost hence investments in subsidiaries and associates are carried at cost less impairment, if any. Where the Company's management has elected to present fair value gains and losses on equity investments in other comprehensive income, there is no subsequent reclassification of fair value gains and losses to profit or loss. Dividends from such investments are recognised in profit or loss as other income when the Company's right to receive payments is established.

(iii) Impairment of financial assets

In accordance with Ind AS 109 Financial Instruments, the Company applies expected credit loss (ECL) model for measurement and recognition of impairment loss associated with its financial assets carried at amortised cost and FVTOCI debt instruments.

For trade receivables or any contractual right to receive cash or another financial asset that result from transactions that are within the scope of Ind AS 115 Revenue from Contracts with Customers, the Company applies simplified approach permitted by Ind AS 109 Financial Instruments, which requires expected life time losses to be recognised after initial recognition of receivables. For recognition of impairment loss on other financial assets and risk exposure, the Company determines whether there has been a significant increase in the credit risk since initial recognition. If credit risk has not increased significantly, twelve months ECL is used to provide for impairment loss. However, if credit risk has increased significantly, lifetime ECL is used. If, in a subsequent period, credit quality of the instrument improves such that there is no longer a significant

increase in credit risk since initial recognition, then the entity reverts to recognising impairment loss allowance based on twelve-months ECL.

ECL represents expected credit loss resulting from all possible defaults and is the difference between all contractual cash flows that are due to the Company in accordance with the contract and all the cash flows that the entity expects to receive, discounted at the original effective interest rate. While determining cash flows, cash flows from the sale of collateral held or other credit enhancements that are integral to the contractual terms are also considered.

ECL is determined with reference to historically observed default rates over the expected life of the trade receivables and is adjusted for forward looking estimates. Note 41(i) details how the Company determines expected credit loss.

(iv) Derecognition of financial assets

A financial asset is derecognised only when the Company

- has transferred the rights to receive cash flows from the financial asset; or
- retains the contractual rights to receive the cash flows of the financial asset, but assumes a contractual obligation to pay the cash flows to one or more recipients.

Where the Company has transferred an asset, it evaluates whether it has transferred substantially all risks and rewards of ownership of the financial asset. In such cases, the financial asset is derecognised. Where the Company has not transferred substantially all risks and rewards of ownership of the financial asset, the financial asset is not derecognised.

Where the Company has neither transferred a financial asset nor retained substantially all risks and rewards of ownership of the financial asset, the financial asset is derecognised if the Company has not retained control of the financial asset. Where the Company retains control of the financial asset, the asset is continued to be recognised to the extent of continuing involvement in the financial asset.

Notes to the Standalone Financial Statements

for the year ended March 31, 2021

(All amounts in ₹ lakhs, unless otherwise stated)

On derecognition of a financial asset in its entirety, the difference between the asset's carrying amount and the sum of the consideration received and receivable and the cumulative gain or loss that had been recognised in other comprehensive income and accumulated in equity is recognised in profit or loss if such gain or loss would have otherwise been recognised in profit or loss on disposal of that financial asset.

On derecognition of a financial asset other than in its entirety, the Company allocates the previous carrying amount of the financial asset between the part it continues to recognise under continuing involvement, and the part it no longer recognises on the basis of the relative fair values of those parts on the date of the transfer. The difference between the carrying amount allocated to the part that is no longer recognised and the sum of the consideration received for the part no longer recognised and any cumulative gain or loss allocated to it that had been recognised in other comprehensive income is recognised in profit or loss if such gain or loss would have otherwise been recognised in profit or loss on disposal of that financial asset. A cumulative gain or loss that had been recognised in other comprehensive income is allocated between the part that continues to be recognised and the part that is no longer recognised on the basis of the relative fair values of those parts.

(v) Effective interest method

The effective interest method is a method of calculating the amortised cost of a debt instrument and of allocating interest income over the relevant period. The effective interest rate is the rate that exactly discounts estimated future cash receipts through the expected life of the financial asset to the gross carrying amount of a financial asset. When calculating the effective interest rate, the Company estimates the expected cash flows by considering all the contractual terms of the financial instrument but does not consider the expected credit losses. Income is recognised on an effective interest basis for debt instruments other than those financial assets classified as at FVTPL.

(r) Financial liabilities and equity instruments

(i) Classification

Debt and equity instruments issued by the Company are classified as either financial liabilities or as equity in accordance with the substance of the contractual arrangements and the definitions of a financial liability and an equity instrument.

Equity instruments

An equity instrument is any contract that evidences a residual interest in the assets of the Company after deducting all of its liabilities.

Financial liabilities

The Company classifies its financial liabilities in the following measurement categories:

- those to be measured subsequently at fair value through profit or loss, and
- those measured at amortised cost.

Financial liabilities are classified as at FVTPL when the financial liability is held for trading or it is designated as at FVTPL, other financial liabilities are measured at amortised cost at the end of subsequent accounting periods.

(ii) Measurement

Equity instruments

Equity instruments issued by the Company are recognised at the proceeds received. Transaction cost of equity transactions shall be accounted for as a deduction from equity.

Financial liabilities

At initial recognition, the Company measures a financial liability at its fair value net of, in the case of a financial liability not at fair value through profit or loss, transaction costs that are directly attributable to the issue of the financial liability. Transaction costs of financial liability carried at fair value through profit or loss are expensed in profit or loss.

Subsequent measurement of financial liabilities depends on the classification of financial liabilities. There are two measurement categories into which the Company classifies its financial liabilities:

Notes to the Standalone Financial Statements

for the year ended March 31, 2021

(All amounts in ₹ lakhs, unless otherwise stated)

- Fair value through profit or loss (FVTPL): Financial liabilities are classified as at FVTPL when the financial liability is held for trading or it is designated as at FVTPL. Financial liabilities at FVTPL are stated at fair value, with any gains or losses arising on remeasurement recognised in profit or loss.
- Amortised cost: Financial liabilities that are not held-for-trading and are not designated as at FVTPL are measured at amortised cost at the end of subsequent accounting periods. The carrying amounts of financial liabilities that are subsequently measured at amortised cost are determined based on the effective interest method. Interest expense that is not capitalised as part of costs of an asset is included in the 'Finance costs' line item.

(iii) Derecognition

Equity instruments

Repurchase of the Company's own equity instruments is recognised and deducted directly in equity. No gain or loss is recognised in profit or loss on the purchase, sale, issue or cancellation of the Company's own equity instruments.

Financial liabilities

The Company derecognises financial liabilities when, and only when, the Company's obligations are discharged, cancelled or have expired. An exchange with a lender of debt instruments with substantially different terms is accounted for as an extinguishment of the original financial liability and the recognition of a new financial liability. Similarly, a substantial modification of the terms of an existing financial liability (whether or not attributable to the financial difficulty of the debtor) is accounted for as an extinguishment of the original financial liability and the recognition of a new financial liability. The difference between the carrying amount of the financial liability derecognised and the consideration paid and payable is recognised in profit or loss.

(iv) Effective interest method

The effective interest method is a method of calculating the amortised cost of a financial liability

and of allocating interest expense over the relevant period. The effective interest rate is the rate that exactly discounts estimated future cash payments through the expected life of the financial liability to the gross carrying amount of a financial liability.

(v) Foreign exchange gains and losses

For financial liabilities that are denominated in a foreign currency and are measured at amortised cost at the end of each reporting period, the foreign exchange gains and losses are determined based on the amortised cost of the instruments and are recognised in 'Other income'. The fair value of financial liabilities denominated in a foreign currency is determined in that foreign currency and translated at the spot rate at the end of the reporting period.

(s) Derivatives

Derivatives are initially recognised at fair value on the date a derivative contract is entered into and are subsequently re-measured to their fair value at the end of each reporting period. The resulting gain or loss is recognised in profit or loss immediately.

(t) Offsetting financial instruments

Financial assets and liabilities are offset and the net amount is reported in the balance sheet where there is a legally enforceable right to offset the recognised amounts and there is an intention to settle on a net basis or realise the asset and settle the liability simultaneously. The legally enforceable right must not be contingent on future events and must be enforceable in the normal course of business and in the event of default, insolvency or bankruptcy of the Company or the counterparty.

(u) Fair value of financial instruments

Fair value measurements are categorised into Level 1, 2 or 3 based on the degree to which the inputs to the fair value measurements are observable and the significance of the inputs to the fair value measurement in its entirety, which are described as follows:

- Level 1 inputs are quoted prices (unadjusted) in active markets for identical assets or liabilities that the Company can access at the measurement date;

Notes to the Standalone Financial Statements

for the year ended March 31, 2021

(All amounts in ₹ lakhs, unless otherwise stated)

- Level 2 inputs are inputs, other than quoted prices included within Level 1, that are observable for the asset or liability, either directly or indirectly; and
- Level 3 inputs are unobservable inputs for the asset or liability.

(v) Statement of cash flows

Cash flows are reported using the indirect method, whereby profit/loss before tax is adjusted for the effects of transactions of a non-cash nature, any deferrals or accruals of past or future operating cash receipts or payments and item of income or expenses associated with investing or financing flows. The cash flows from operating, investing and financing activities of the Company are segregated.

(w) Cash and cash equivalents

Cash and cash equivalents in the balance sheet comprise of cash on hand, cheques on hand, balance with banks on current accounts and short term, highly liquid investments with an original maturity of three months or less and which carry insignificant risk of change in value.

For the purpose of statement of cash flows, cash and cash equivalents consist of cash and cash equivalents as defined above.

(x) Earnings per share

Basic earnings per share is calculated by dividing the profit attributable to owners of the Company by the weighted average number of equity shares outstanding during the financial year, adjusted for bonus elements in equity shares issued during the year and excluding treasury shares.

Diluted earnings per share adjusts the figures used in the determination of basic earnings per share to take into account the after income tax effect of interest and financing costs associated with dilutive potential equity shares and the weighted average number of additional equity shares that would have been outstanding assuming the conversion of all dilutive potential equity shares.

(y) Segment reporting

Operating segments are reported in a manner consistent with the internal reporting provided to the chief operating decision maker. Refer note 37 for segment information presented.

NOTE 2: CRITICAL ACCOUNTING JUDGEMENTS AND KEY SOURCES OF ESTIMATION UNCERTAINTY

The preparation of financial statements requires the use of accounting estimates which, by definition, will seldom equal the actual results. Management also needs to exercise judgement in applying the Company's accounting policies.

This note provides an overview of the areas that involved a higher degree of judgement or complexity, and of items which are more likely to be materially adjusted due to estimates and assumptions turning out to be different than those originally assessed.

Estimates and judgements are continually evaluated. They are based on historical experience and other factors, including expectations of future events that may have a financial impact on the Company and that are believed to be reasonable under the circumstances.

(a) Critical accounting judgements

Following are the areas which involved complex and subjective judgements:

(i) Incentives under the U.P. Sugar Industry Promotion Policy, 2004

In a writ petition filed by the Company against the illegal withdrawal of U.P. Sugar Industry Promotion Policy, 2004 ("the Policy") by the State Government of Uttar Pradesh, the Hon'ble Allahabad High Court had decided the matter in favour of the Company and directed the State Government to quantify and pay all the incentives that were promised under the said Policy. The State Government however filed a Special Leave Petition before the Hon'ble Supreme Court challenging the decision of the Hon'ble High Court against it.

While the case was sub-judice, the Company continued to avail the remissions of statutory levies and duties aggregating to ₹ 4158.38 lakhs, which it was entitled to under the Policy, in accordance with the interim directions of the High Court. Based on the aforesaid decision of Hon'ble Allahabad High Court in its favour, the Company is pursuing for its claim of ₹ 11375 lakhs filed towards one time capital subsidy and shall pursue its claims towards other incentives by way of reimbursements against specified expenses aggregating to and ₹ 13015.88 lakhs, by filing necessary documents for the

Notes to the Standalone Financial Statements

for the year ended March 31, 2021

(All amounts in ₹ lakhs, unless otherwise stated)

verification of the State Government authorities. The aforesaid amounts do not include any interest towards delayed settlement.

In view of uncertainties involved on account of the fact that the State Government has challenged the decision rendered against it and since the process of verification and quantification of claims by the State Government for the incentive period of 10 years is yet to be taken up, the Company has not recognised the above benefits/incentives receivable under the Policy.

(ii) Society commission

In the cane price package offered by the State Government of Uttar Pradesh ("State Government") to sugar mills, the State Government had reduced the rate of commission payable to cane societies for sugar season 2012-13 and 2014-15 by way of notification dated 12 June 2015 and for 2015-16 vide notification dated 5 February 2016, to provide relief to the Sugar Industry in view of disparity in the cane price and the market outlook of the sugar prices. In the writ petitions filed by certain cane societies against such reduction in commission rates, the Hon'ble Allahabad High Court has held that these notifications cannot have retrospective applicability. The reduction in the rate of commission payable being part of the relief package announced by the State Government, the Company believes that the State Government is not likely to pass the cost burden upon the sugar industry and instead, may explore other ways to meet the outcome of the order of the Court. Accordingly, no provision to this effect has been considered necessary.

(iii) Central Government subsidies

As a measure of relief to the sugar industry, to facilitate export and for speedy cane payments, the Central Government announced incentives to the sugar industry for the sugar season 2020-21 whereby sugar mills shall be entitled to assistance towards marketing and transportation costs related to export of sugar upto the Maximum Admissible Export Quantity (MAEQ) as determined by the Central Government and allocated to respective sugar mills. The incentives announced shall be made available to the sugar mills upon fulfilment

of prescribed conditions and stipulations which mainly includes export of atleast 50% of its MAEQ of sugar. In addition, the Central Government has the power to withdraw/amend the scheme at any time, based upon its monitoring of prevailing sugar prices and review of availability position of sugar.

Upon assessment of the conditions prescribed, the Company has recognized such subsidy in respect of quantities of sugar for which substantive condition of the abovesaid scheme has been fulfilled (i.e. to the extent of sugar quantities of which export completed till the year end subject to the condition that such exports are atleast 50% of MAEQ allocated to specific sugar mill). The Company will recognise subsidy in subsequent period in respect of quantities of sugar for which export is under process as at the year end, on consideration of prudence. The estimated amount of subsidy in respect of such sugar in the process of export as at 31 March 2021 is ₹ 5700.08 lakhs.

(b) Key sources of estimation uncertainty

Following are the key assumptions concerning the future, and other key sources of estimation uncertainty at the end of the reporting period that may have a significant risk of causing a material adjustment to the carrying amounts of assets and liabilities within the next financial year:

(i) Global health pandemic from COVID-19

The outbreak of COVID-19 pandemic in India during last year has caused significant disturbance and slowdown of economic activity. During the period of lockdown in the first quarter of the financial year, the main business of the Company i.e. Sugar business, comprising manufacture of sugar and allied activities of cogeneration of power and distillation of ethanol, being essential goods, continued to operate uninterrupted. However, the engineering businesses were closed for about 3-5 weeks during that lockdown period subsequent to which these have resumed normal operation by the second week of May'2020. The second wave of outbreak of COVID-19, which started towards the end of the financial year and continued subsequent to the closure of the financial year, has impacted the operations of engineering businesses to

Notes to the Standalone Financial Statements

for the year ended March 31, 2021

(All amounts in ₹ lakhs, unless otherwise stated)

some extent due to precautionary steps taken to safeguard our employees, disturbance in supply chain due to impact of pandemic at vendor's end, reduced availability of labour and non-supply of oxygen for industrial purposes in the first quarter of the financial year 2021-22. The Company has evaluated the impact of this pandemic on its business operations and financial position using internal and external sources of information, including economic forecasts and estimates from market sources, and based on its review of current indicators of future economic conditions, there is no significant impact on carrying amount of the assets due to impairment and on its financial results for the year ended 31 March 2021. However, the impact assessment of COVID-19 is a continuing process given the uncertainties associated with its nature and duration and accordingly the impact may be different in future from that estimated as at the date of approval of these financial statements. The Company will continue to monitor any material changes to future economic conditions.

(ii) Fair value measurements and valuation processes

Some of the Company's assets and liabilities are measured at fair value for financial reporting purposes. When the fair values of these assets and liabilities cannot be measured based on quoted prices in active markets, their fair value is measured using valuation techniques by engaging third party qualified external valuers or internal valuation team to perform the valuation. The inputs to these models are taken from observable markets where possible, but where this is not feasible, a degree of judgement is required in establishing fair values. Judgements include considerations of inputs such as liquidity risk, credit risk and volatility. Changes in assumptions about these factors could affect the reported fair value of financial instruments. See note 4, 6, 9, 17 and 42 for further disclosures.

(iii) Employee benefit plans

The cost of employee benefits under the defined benefit plan and other long term employee benefits as well as the present value of the obligation there against are determined using actuarial valuations. An actuarial valuation involves making

various assumptions that may differ from actual developments in the future. These include the determination of the discount rate, future salary increases, attrition and mortality rates. Due to the complexities involved in the valuation and its long-term nature, obligation amount is highly sensitive to changes in these assumptions.

The parameter most subject to change is the discount rate. In determining the appropriate discount rate for plans, the management considers the market yields on government bonds with a maturity term that is consistent with the term of the concerned defined benefit obligation. Future salary increases are based on expected future inflation rates and expected salary trends in the industry. Attrition rates are considered based on past observable data of employees leaving the services of the Company. The mortality rate is based on publicly available mortality tables. Those mortality tables tend to change only at intervals in response to demographic changes. See note 38 for further disclosures.

(iv) Impairment of trade receivables

The Company has a stringent policy of ascertaining impairment, if any, as result of detailed scrutiny of major cases and through determining expected credit losses. Despite best estimates and periodic credit appraisals of customers, the Company's receivables are exposed to delinquency risks due to material adverse changes in business, financial or economic conditions that are expected to cause a significant change to the party's ability to meet its obligations. All such parameters relating to impairment or potential impairment are reviewed at each reporting date. See note 41(i) for further disclosures.

(v) Revenue and cost estimation for construction contracts

The revenue recognition pertaining to construction contracts are determined on proportionate completion method based on actual construction contract costs incurred till balance sheet date and total budgeted construction contract costs. An estimation of total budgeted construction contract cost involves making various assumptions that may

Notes to the Standalone Financial Statements

for the year ended March 31, 2021

(All amounts in ₹ lakhs, unless otherwise stated)

differ from the actual developments in the future. These include delays in execution due to unforeseen reasons, inflation rate, future material rates, future labour rates etc. The estimates/assumptions are made considering past experience, market/inflation trends and technological developments etc. All such estimates/ assumptions are reviewed at each reporting date.

(vi) Provision for warranty claims

The Company, in the usual course of sale of its products, provides warranties on certain products and services, undertaking to repair or replace the items that fail to perform satisfactorily during the specified warranty period. Provisions made represent the amount of expected cost of meeting such obligations of rectifications / replacements based on best estimate considering the historical warranty claim information and any recent trends that may suggest future claims could differ from historical amounts. The assumptions made in relation to the current period are consistent with those in the prior years.

(vii) Provision for litigations and contingencies

The provision for litigations and contingencies are determined based on evaluation made by the management of the present obligation arising from past events the settlement of which is expected to result in outflow of resources embodying economic benefits, which involves judgements around

estimating the ultimate outcome of such past events and measurement of the obligation amount.

(viii) Useful life and residual value of plant, property equipment and intangible assets

The useful life and residual value of plant, property equipment and intangible assets are determined based on technical evaluation made by the management of the expected usage of the asset, the physical wear and tear and technical or commercial obsolescence of the asset. Due to the judgements involved in such estimations, the useful life and residual value are sensitive to the actual usage in future period.

(ix) Current taxes and deferred taxes

Significant judgement is required in determination of taxability of certain incomes and deductibility of certain expenses during the estimation of the provision for income taxes.

Deferred tax assets are recognised for deductible temporary differences and carry forward of unused tax losses and tax credits to the extent that it is probable that taxable profit would be available against which such deferred tax assets could be utilised. Significant management judgement is required to determine the amount of deferred tax assets that can be recognised, based upon the likely timing and the level of future taxable profits together with future tax optimisation strategies.

Notes to the Standalone Financial Statements

for the year ended March 31, 2021

(All amounts in ₹ lakhs, unless otherwise stated)

	Property, plant and equipment										Capital work-in-progress	
	Freehold Land	Leasehold Land	Right-of-use assets (Land)	Buildings & Roads	Right-of-use assets (Building)	Plant and Equipment	Furniture & Fixtures	Vehicles	Office Equipment	Computers		Total
Year ended 31 March 2020												
Gross carrying amount												
Opening gross carrying amount	3567.74	783.24	-	20682.72	-	77881.61	300.18	1239.08	381.68	561.53	105397.78	20533.58
Opening reclassifications/recognitions	-	(349.66)	353.14	-	2232.26	-	-	-	-	-	2235.74	-
Additions	-	1553.17	-	1796.77	25.81	25516.05	111.27	236.15	243.18	249.56	29731.96	5546.87
Disposals	-	-	-	(10.09)	(68.28)	(156.91)	(1.81)	(97.96)	(12.78)	(11.25)	(359.08)	(33.21)
Transfers*	-	-	-	-	-	-	-	-	-	-	-	(23408.30)
Other adjustments	-	-	-	(0.48)	-	-	-	-	(0.48)	0.48	-	-
Closing gross carrying amount	3567.74	1986.75	353.14	22469.40	2189.79	103240.75	409.64	1377.27	611.60	800.32	137006.40	2638.94
Accumulated depreciation and impairment												
Opening accumulated depreciation and impairment	-	18.56	-	2826.57	-	18573.56	167.65	372.32	153.49	293.63	22405.78	56.31
Opening reclassifications/recognitions	-	(18.56)	18.56	-	-	-	-	-	-	-	-	-
Depreciation charge during the year	-	-	5.40	984.32	626.64	5463.49	31.07	154.66	58.71	134.49	7458.78	-
Disposals	-	-	-	(1.76)	(68.28)	(96.37)	(1.37)	(67.93)	(9.83)	(5.96)	(251.50)	(33.21)
Other adjustments	-	-	-	-	-	-	-	-	(0.62)	0.62	-	-
Closing accumulated depreciation and impairment	-	-	23.96	3809.13	558.36	23940.68	197.35	459.05	201.75	422.78	29613.06	23.10
Net carrying amount	3567.74	1986.75	329.18	18660.27	1631.43	79300.07	212.29	918.22	409.85	377.54	107393.34	2615.84
Year ended 31 March 2021												
Gross carrying amount												
Opening gross carrying amount	3567.74	1986.75	353.14	22469.40	2189.79	103240.75	409.64	1377.27	611.60	800.32	137006.40	2638.94
Additions	307.07	-	6.68	1285.33	132.81	4793.69	28.20	162.29	110.26	213.87	7040.20	3867.95
Disposals	-	-	-	(735.36)	(282.33)	(181.67)	(1.83)	(29.95)	(13.46)	(12.29)	(1256.89)	(23.10)
Transfers*	-	-	-	-	-	-	-	-	-	-	-	(4260.34)
Closing gross carrying amount	3874.81	1986.75	359.82	23019.37	2040.27	107852.77	436.01	1509.61	708.40	1001.90	142789.71	2223.43
Accumulated depreciation and impairment												
Opening accumulated depreciation and impairment	-	-	23.96	3809.13	558.36	23940.68	197.35	459.05	201.75	422.78	29613.06	23.10
Depreciation charge during the year	-	-	5.69	1084.54	552.39	5778.28	36.79	162.53	89.39	150.96	7860.57	-
Disposals	-	-	-	(156.14)	(268.52)	(116.15)	(1.09)	(20.85)	(10.14)	(9.24)	(582.13)	(23.10)
Closing accumulated depreciation and impairment	-	-	29.65	4737.53	842.23	29602.81	233.05	600.73	281.00	564.50	36891.50	-
Net carrying amount	3874.81	1986.75	330.17	18281.84	1198.04	78249.96	202.96	908.88	427.40	437.40	105898.21	2223.43

* Represents amount capitalised during the year under property, plant and equipment out of capital work-in-progress.

Notes:

- (i) **Leasehold land**
This comprises certain land acquired under agreements on perpetual lease terms from the Government and accordingly, classified and accounted for under Ind AS 16 Property, Plant and Equipment. Under the terms of the perpetual lease agreements, the Company has the right to sub-lease/ assign/ transfer such land except in case of one perpetual lease relating to a small parcel of land where prior approval of the specified authority is required in case sub-lease/ assignment/ transfer relates to a part of such land demised under the lease.
- (ii) **Restrictions on Property, plant and equipment**
Refer note 16(i) & 20(i) for information on charges created on property, plant and equipment. Further, freehold land includes land having carrying amount of ₹ 13.13 lakhs for which transfer of titles in the name of the Company is pending.
- (iii) **Contractual commitments**
Refer note 45 for disclosure of contractual commitments for the acquisition of property, plant and equipment.
- (iv) **Capital work-in-progress**
Capital work-in-progress mainly comprises of a new distillery plant being constructed at Milak Narayanpur, building under construction (viz. sugar godown etc.) and plant & equipment (viz. Pollution control equipment etc.) under the process of installation pertaining to Sugar & Distillery business of the Company.

Notes to the Standalone Financial Statements

for the year ended March 31, 2021

(All amounts in ₹ lakhs, unless otherwise stated)

NOTE 4: INVESTMENT PROPERTY

	Year Ended 31-Mar-21	Year Ended 31-Mar-20
Gross carrying amount		
Opening gross carrying amount	538.58	821.14
Additions	-	-
Disposals	(96.54)	(279.51)
Classified as held for sale (refer note 13)	-	(3.05)
Closing gross carrying amount	442.04	538.58
Accumulated depreciation and impairment		
Opening accumulated depreciation	-	-
Depreciation charge/impairment losses	-	-
Closing accumulated depreciation and impairment	-	-
Net carrying amount	442.04	538.58

(i) Description about investment properties

Investment properties consist of :

- (a) various parcels of freehold land located in the states of Uttar Pradesh.
- (b) an office flat owned by the Company having carrying amount of ₹ 0.12 lakhs, constructed by a Society on a leasehold land at Mumbai.

(ii) Amount recognised in statement of profit and loss

	Year Ended 31-Mar-21	Year Ended 31-Mar-20
Rental income from office flat at Mumbai	13.56	15.24
Direct operating expenses on property that generated rental income	-	-
Direct operating expenses on property that did not generate rental income	(10.46)	(10.11)
Profit from investment properties before depreciation	3.10	5.13
Depreciation	-	-
Profit from investment properties	3.10	5.13

(iii) Restrictions on realisability and contractual obligations

The Company has no restrictions on the realisability of any of its investment properties and it is under no contractual obligations to either purchase, construct or develop investment properties or for repairs, maintenance and enhancements.

(iv) Fair value

	As at 31-Mar-21	As at 31-Mar-20
Investment properties		
- Various parcels of freehold land located in the states of Uttar Pradesh.	*	*
- Office flat at Mumbai	502.98	503.88

*The parcels of land owned by the Company are situated in the sugar belts of Uttar Pradesh. In view of slowdown in real estate and industrial activities, the circle rates may not be fully reflective of the fair value in the absence of transactions of similar properties (including size) in the vicinity of the subject properties.

Estimation of fair value of office flat at Mumbai

The valuation of the office flat situated at Mumbai has been carried by a registered approved valuer, conversant with and having knowledge of real estate activities in the concerned area, based on prevalent rates and other observable market inputs (Level 2 fair value).

Notes to the Standalone Financial Statements

for the year ended March 31, 2021
 (All amounts in ₹ lakhs, unless otherwise stated)

NOTE 5: INTANGIBLE ASSETS

	Computer software
Year ended 31 March 2020	
Gross carrying amount	
Opening gross carrying amount	287.18
Additions	77.24
Disposals	-
Closing gross carrying amount	364.42
Accumulated amortisation	
Opening accumulated amortisation	239.47
Amortisation charge for the year	31.83
Disposals	-
Closing accumulated amortisation	271.30
Closing net carrying amount	93.12
Year ended 31 March 2021	
Gross carrying amount	
Opening gross carrying amount	364.42
Additions	80.84
Disposals	(0.23)
Closing gross carrying amount	445.03
Accumulated amortisation	
Opening accumulated amortisation	271.30
Amortisation charge for the year	50.28
Disposals	(0.23)
Closing accumulated amortisation	321.35
Closing net carrying amount	123.68

Notes to the Standalone Financial Statements

for the year ended March 31, 2021

(All amounts in ₹ lakhs, unless otherwise stated)

NOTE 6: INVESTMENTS

	As at 31-Mar-21	As at 31-Mar-20
At Cost		
Quoted Investments (fully paid-up)		
Investments in Equity Instruments		
- of Associate		
70,627,980 (31 March 2020: 70,627,980) Equity shares of ₹ 1/- each of Triveni Turbine Limited	706.35	706.35
Total aggregate quoted investments	706.35	706.35
Unquoted Investments (fully paid-up)		
Investments in Equity Instruments		
- of Subsidiaries		
26,500,000 (31 March 2020: 26,500,000) Equity shares of ₹ 1/- each of Triveni Engineering Limited	265.00	265.00
38,500,000 (31 March 2020: 38,500,000) Equity shares of ₹ 1/- each of Triveni Energy Systems Limited	385.00	385.00
20,500,000 (31 March 2020: 20,500,000) Equity shares of ₹ 1/- each of Triveni Sugar Limited	205.00	205.00
45,500,000 (31 March 2020: 45,500,000) Equity shares of ₹ 1/- each of Svastida Projects Limited	455.00	455.00
4,170,000 (31 March 2020: 4,170,000) Equity shares of ₹ 10/- each of Triveni Entertainment Limited	404.02	404.02
20,050,000 (31 March 2020: 20,050,000) Equity shares of ₹ 1/- each of Triveni Industries Limited	200.50	200.50
135,030,000 (31 March 2020: 135,030,000) Equity shares of ₹ 1/- each of Mathura Wastewater Management Private Limited	1350.30	1350.30
20,000,000 (31 March 2020: Nil) Equity shares of ₹ 1/- each of Gaurangi Enterprises Limited	200.00	-
100,000 (31 March 2020: Nil) Equity shares of ₹ 1/- each of Triveni Foundation (incorporated u/s 8 of the Companies Act, 2013)	1.00	-
400,000 (31 March 2020: Nil) Equity shares of ₹ 10/- each of United Shippers & Dredgers Limited	23.00	-
- of Associate		
Nil (31 March 2020: 13,008) Equity shares of New Israeli Shekel 0.10 each of Aqwise Wise Water Technologies Limited (Israel) (refer note 13)	-	3006.19
Total aggregate unquoted investments	3488.82	6271.01
Total non-current investments carried at cost [A]	4195.17	6977.36

Notes to the Standalone Financial Statements

for the year ended March 31, 2021

(All amounts in ₹ lakhs, unless otherwise stated)

	As at 31-Mar-21	As at 31-Mar-20
At Amortised cost		
Unquoted Investments (fully paid-up)		
Investments in Government or trust securities		
National Saving Certificates (kept as security)	0.03	0.03
Investments in Bonds		
2,000 (31 March 2020 : Nil) 9.25% bonds of ₹ 1,000/- of Dewan Housing Finance Corporation Ltd SR-V B	6.00	-
24,600 (31 March 2020 : Nil) 9.25% bonds of ₹ 1,000/- of Dewan Housing Finance Corporation Ltd SR-III	73.80	-
12,200 (31 March 2020 : Nil) 9.10% bonds of ₹ 1,000/- of Dewan Housing Finance Corporation Ltd. SR-VI A	36.60	-
500 (31 March 2020 : Nil) 9.30% bonds of ₹ 1,000/- of Dewan Housing Finance Corporation Ltd SR-VI B	1.50	-
2,000 (31 March 2020 : Nil) 9.55% of ₹ 1,000/- bonds of IL&FS Financial Services Ltd. SR-V	0.20	-
3,000 (31 March 2020 : Nil) 8.85% of ₹ 1,000/- bonds of IL&FS Financial Services Ltd. SR-VI	6.00	-
4,000 (31 March 2020 : Nil) 8.75% of ₹ 1,000/- bonds of IL&FS Financial Services Ltd. SR-III	8.00	-
9,700 (31 March 2020 : Nil) 8.65% of ₹ 1,000/- bonds of IL&FS Financial Services Ltd. SR-XVI	0.97	-
5,100 (31 March 2020 : Nil) 8.23% of ₹ 1,000/- bonds of IL&FS Financial Services Ltd. SR-I	10.20	-
2,000 (31 March 2020 : Nil) 8.70% of ₹ 1,000/- bonds of IL&FS Financial Services Ltd. SR-I	4.00	-
3,000 (31 March 2020 : Nil) 9.50% of ₹ 1,000/- bonds of Infrastructure Leasing & Financial Services Ltd. SR-II C	6.00	-
6,000 (31 March 2020 : Nil) 9.00% of ₹ 1,000/- bonds of Infrastructure Leasing & Financial Services Ltd. SR-I-H (O-1)	12.00	-
Total non-current investments carried at amortised cost [B]	165.30	0.03
At Fair value through Profit or Loss (FVTPL) (refer note 42)		
Quoted Investments (fully paid-up)		
Investments in Equity Instruments		
13,500 (31 March 2020: 13,500) Equity shares of ₹ 2/- each of Housing Development Finance Corporation Limited	337.25	220.47
5,000 (31 March 2020: 5,000) Equity shares of ₹ 1/- each of HDFC Bank Limited	74.68	43.09
24,175 (31 March 2020: 24,175) Equity shares of ₹ 2/- each of Punjab National Bank	8.86	7.82
76 (31 March 2020: 76) Equity shares of ₹ 10/- each of Central Bank of India	0.01	0.01
3,642 (31 March 2020: 3,642) Equity shares of ₹ 5/- each of NBI Industrial Finance Co. Limited	71.33	51.38
Total aggregate quoted investments	492.13	322.77

Notes to the Standalone Financial Statements

for the year ended March 31, 2021

(All amounts in ₹ lakhs, unless otherwise stated)

	As at 31-Mar-21	As at 31-Mar-20
Unquoted Investments (fully paid-up)		
Investments in Bonds		
Nil (31 March 2020: 1) 8.57% bonds of ₹ 10 lakhs each of Central Bank of India	-	10.67
Total aggregate unquoted investments	-	10.67
Total non-current investments carried at FVTPL [C]	492.13	333.44
Total non-current investments ([A]+[B]+[C])	4852.60	7310.83
Total non-current investments	4852.60	7310.83
Aggregate amount of quoted investments	1198.48	1029.12
Aggregate amount of market value of quoted investment	72391.41	41640.14
Aggregate amount of unquoted investments	3654.12	6281.71
Aggregate amount of impairment in the value of investments	-	-

Details of the Company's subsidiaries and associates at the end of the reporting period are as follows:

Name of Subsidiaries / Associates	Place of incorporation and operation	Proportion of ownership interest and voting power held by the Company	
		As at 31-Mar-21	As at 31-Mar-20
Subsidiaries			
Triveni Engineering Limited	India	100%	100%
Triveni Energy Systems Limited	India	100%	100%
Svastida Projects Limited	India	100%	100%
Triveni Entertainment Limited	India	100%	100%
Triveni Industries Limited	India	100%	100%
Triveni Sugar Limited	India	100%	100%
Mathura Wastewater Management Private Limited	India	100%	100%
Gaurangi Enterprises Limited	India	100%	N.A.
Triveni Foundation	India	100%	N.A.
United Shippers & Dredgers Limited	India	100%	N.A.
Associates			
Triveni Turbine Limited	India	21.85%	21.85%
Aqwise Wise Water Technologies Limited	Israel	Refer note 13	25.04%

Notes to the Standalone Financial Statements

for the year ended March 31, 2021

(All amounts in ₹ lakhs, unless otherwise stated)

NOTE 7: TRADE RECEIVABLES

	As at 31-Mar-21		As at 31-Mar-20	
	Current	Non- current	Current	Non- current
Trade receivables (at amortised cost)				
- Considered good - Unsecured	22074.05	125.84	29649.44	29.73
- Trade receivables which have significant increase in credit risk	-	1004.59	-	614.57
- Trade receivables - Credit impaired	-	969.40	-	1039.11
Less: Allowance for bad and doubtful debts	(136.99)	(1973.99)	(147.65)	(1653.68)
Total trade receivables	21937.06	125.84	29501.79	29.73

(i) Refer note 41(i) for credit risk, impairment of trade receivables under expected credit loss model and other related disclosures.

NOTE 8: LOANS

	As at 31-Mar-21		As at 31-Mar-20	
	Current	Non- current	Current	Non- current
At amortised cost				
Loan to related parties (refer note 39)				
- Loans receivables considered good - Unsecured	1831.47	2000.00	291.53	1510.00
- Loans receivables - Credit impaired*	-	44.53	-	-
Less: Allowance for bad and doubtful loans	-	(44.53)	-	-
	1831.47	2000.00	291.53	1510.00
Loan to employees				
- Loans receivables considered good - Unsecured	11.74	2.46	45.86	1.82
Loan to others				
- Loans receivables considered good - Unsecured	0.56	-	0.57	-
- Loans receivables - Credit impaired*	-	-	-	44.53
Less: Allowance for bad and doubtful loans	-	-	-	(44.53)
	0.56	-	0.57	-
Total loans	1843.77	2002.46	337.96	1511.82

(i) Loan to related parties includes loan of ₹ 2000 lakhs (31 March 2020: ₹ 1510 lakhs) provided to a wholly owned subsidiary company, Mathura Wastewater Management Private Limited (MWMPL), as part of promoter's contribution, as stipulated by the Lender for financing the project to be executed by MWMPL and loan of ₹ 1831.47 lakhs (31 March 2020: ₹ 291.53 lakhs) provided to an Israeli based associate company, Aqwise Wise Water Technologies Limited, for meeting its working capital requirements (refer note 13).

* During the year, the Company has acquired the entire shareholding in United Shippers & Dredgers Limited and accordingly, it has become a wholly owned subsidiary of the Company.

Notes to the Standalone Financial Statements

for the year ended March 31, 2021

(All amounts in ₹ lakhs, unless otherwise stated)

NOTE 9: OTHER FINANCIAL ASSETS

	As at 31-Mar-21		As at 31-Mar-20	
	Current	Non- current	Current	Non- current
At amortised cost				
Security deposits (see (i) below)	26.38	671.10	45.65	639.92
Earnest money deposits	48.13	2.00	51.73	2.00
Less: Allowance for bad and doubtful deposits	(0.15)	-	(0.15)	-
	47.98	2.00	51.58	2.00
Bank balances:				
Earmarked balances with banks:				
- Deposit against molasses storage fund (refer note 15(vi))	-	244.27	-	195.89
Balances under lien/margin/kept as security:				
- Post office savings account	-	0.19	-	0.19
- Fixed / margin deposits	-	474.24	-	73.82
Other balances:				
- Fixed deposits	-	4.20	-	4.20
	-	722.90	-	274.10
Accrued interest	53.61	0.68	52.94	1.90
Insurance claim recoverable	122.38	-	54.79	-
Miscellaneous other financial assets	8.15	14.90	3.12	14.90
Less: Allowance for bad and doubtful assets	-	(14.90)	-	(14.90)
	8.15	-	3.12	-
Total other financial assets at amortised cost [A]	258.50	1396.68	208.08	917.92
At fair value through Profit or Loss (FVTPL) (refer note 42)				
Derivatives financial instruments carried at fair value				
- Foreign exchange forward contracts	35.92	-	-	-
Total other financial assets at FVTPL [B]	35.92	-	-	-
Total other financial assets ([A]+[B])	294.42	1396.68	208.08	917.92

- (i) Investment of ₹ 82.95 lakhs (31 March 2020: ₹ 79.72 lakhs) in equity shares of Atria Wind Power (Bijapur1) Private Limited, under group captive arrangement to source power, has been considered as security deposit in accordance with applicable accounting standards.

Notes to the Standalone Financial Statements

for the year ended March 31, 2021

(All amounts in ₹ lakhs, unless otherwise stated)

NOTE 10: OTHER ASSETS

	As at 31-Mar-21		As at 31-Mar-20	
	Current	Non- current	Current	Non- current
Capital advances	-	1671.66	-	238.25
Advances to suppliers	1105.32	18.06	1084.87	18.06
Less: Allowance for bad and doubtful advances	(54.89)	(18.06)	(54.89)	(18.06)
	1050.43	-	1029.98	-
Advances to related parties (refer note 39)	1.16	-	1.16	-
Indirect tax and duties recoverable	2929.79	314.69	2105.96	309.76
Less: Allowance for bad and doubtful amounts	(13.82)	(1.46)	(13.82)	(1.46)
	2915.97	313.23	2092.14	308.30
Deposit with sales tax authorities	166.95	6.55	142.73	6.55
Bank guarantee encashment recoverable	-	200.00	-	200.00
Less: Allowance for bad and doubtful claims	-	(200.00)	-	(200.00)
	-	-	-	-
Export incentives receivable	35.22	-	28.73	-
Less: Allowance for bad and doubtful claims	(7.46)	-	(7.46)	-
	27.76	-	21.27	-
Government grant receivables (refer note 43)	4535.96	-	23513.85	-
Advances to employees	41.37	1.45	30.55	1.45
Prepaid expenses	789.03	29.04	727.72	44.88
Due from customers under construction contracts [see (ii) below]	5611.67	-	7251.03	-
Unbilled revenue [see (ii) below]	23.17	-	144.30	-
Customer retentions [see (i) and (ii) below]	10804.05	-	8784.88	-
Less: Allowance for bad and doubtful debts	(121.02)	-	(61.66)	-
	10683.03	-	8723.22	-
Miscellaneous other assets	100.13	112.31	73.19	121.98
Less: Allowance for bad and doubtful assets	-	(20.78)	-	(20.90)
	100.13	91.53	73.19	101.08
Total other assets	25946.63	2113.46	43751.14	700.51

- (i) Customer retentions include ₹ 2139.68 lakhs (31 March 2020 : ₹ 6017.73 lakhs) expected to be received after twelve months within the operating cycle.

Notes to the Standalone Financial Statements

for the year ended March 31, 2021

(All amounts in ₹ lakhs, unless otherwise stated)

(ii) Contract balances

	As at 31-Mar-21	As at 31-Mar-20
Contract assets		
- Amounts due from customers under construction contracts	5611.67	7251.03
- Unbilled revenue	23.17	144.30
- Customer retentions	10683.03	8723.22
Contract liabilities		
- Amounts due to customers under construction contracts	8080.18	5873.72
- Advance from customers	4672.67	5330.66

- (a) Contract assets are initially recognised for revenue earned but not billed pending successful achievement of milestones. Upon achievement of milestones and billing, contract assets are reclassified to trade receivables. A trade receivable represents the Company's right to an amount of consideration that is billed on the customer and which become due unconditionally (i.e. only the passage of time is required before payment of the consideration is due). Different businesses of the Company have their different credit terms [refer note 41(i)].

Contract costs incurred to date plus recognised profits or less recognised losses are compared with progress billings raised on the customer - any surplus is considered as contract assets and shown as amounts due from customers under construction contracts, whereas any shortfall is considered as contract liabilities and shown as the amounts due to customers under construction contracts. Amounts of revenue earned for service work performed pending billing on customers is also considered as contract assets and shown as unbilled revenue. Amounts billed for work performed which will become due upon fulfillment of specified conditions is considered as contract assets and shown as customer retentions. Amounts received before the related work is performed is considered as contract liabilities and is shown as advances from customers.

- (b) Significant changes in contract assets and liabilities:

Decrease in contract assets (Due from customers under construction contracts) has resulted due to billing in the current year of substantial work carried out in the previous year upon achieving contractual milestones, mainly in respect of sewage treatment projects in the municipal segment.

Increase in contract assets (Customer retentions) is mainly attributable to significant billing done during the current year upon achieving contractual milestones, mainly in respect of wastewater/sewage treatment projects in the municipal segment. As per the contractual terms, a specified percentage of the billing will be retained by the customer and will become due upon fulfillment of specified conditions.

Increase in contract liabilities (Amount due to customers under construction contracts) is due to the reason that against the billing done during the year, the revenue recognised in accordance with Ind AS 115 Revenue from Contracts with Customers is lower, mainly in respect of sewage treatment projects in the municipal segment.

Decrease in contract liabilities (Advances from Customers) is due to adjustment of mobilisation advances as a result of progressive/final billings and due to lower advances received against fresh orders.

Notes to the Standalone Financial Statements

for the year ended March 31, 2021

(All amounts in ₹ lakhs, unless otherwise stated)

- (c) Revenue recognised in relation to contract liabilities:

The following table shows how much of the revenue recognised in the current reporting period relates to carried-forward contract liabilities and how much relates to performance obligations that were satisfied in a prior year.

	Year ended 31-Mar-21	Year ended 31-Mar-20
Revenue recognised that was included in the contract liability balance at the beginning of the period	14584.54	5832.92
Revenue recognised from performance obligations satisfied in previous periods	-	-

NOTE 11: INVENTORIES

	As at 31-Mar-21	As at 31-Mar-20
Raw materials and components	3883.10	2988.14
Less: Provision for obsolescence/slow moving raw materials and components	(114.32)	(129.71)
Work-in-progress	2609.73	3406.72
Finished goods [including stock in transit ₹ 2184.92 lakhs as at 31 March 2021 (31 March 2020: ₹ 686.69 lakhs)]	161840.87	180701.02
Stock in trade	44.89	28.41
Stores and spares [including stock in transit ₹ 0.92 lakhs as at 31 March 2021 (31 March 2020: ₹ 1.49 lakhs)]	5335.85	4389.51
Less: Provision for obsolescence/slow moving stores and spares	(287.53)	(278.14)
Others - Scrap & low value patterns	62.33	106.74
Total inventories	173374.92	191212.69

- (i) The cost of inventories recognised as an expense during the year was ₹ 397630.43 lakhs (31 March 2020: ₹ 373266.32 lakhs).
- (ii) Refer note 20(i) for information on charges created on inventories.
- (iii) The mode of valuation of inventories has been stated in note 1(l).
- (iv) All inventories are expected to be utilised/sold within twelve months except certain items of stores and spares, which are utilised on need basis. Quantum of such stores and spares, which may be utilised beyond one year, is not determinable and is not expected to be material with reference to the total value of inventories.
- (v) For impairment losses recognised during the year refer note 25 & 33.
- (vi) In addition to the cost of inventories recognised as expense as mentioned in (i) above, there are write-downs of inventories to net realisable value amounting to ₹ 31.52 lakhs [31 March 2020: reversal of write-downs of ₹ 143.12 lakhs (net of write-downs of ₹ 226.42 lakhs)] which are also recognised as an expense/income during the year and included in 'Changes in inventories of finished goods, stock-in-trade and work-in-progress' in statement of profit and loss.

Notes to the Standalone Financial Statements

for the year ended March 31, 2021

(All amounts in ₹ lakhs, unless otherwise stated)

NOTE 12: CASH AND BANK BALANCES

(a) Cash and cash equivalents

	As at 31-Mar-21	As at 31-Mar-20
At amortised cost		
Balances with banks	928.49	2969.52
Cheques / drafts on hand	40.11	60.93
Cash on hand	23.81	27.85
Total cash and cash equivalents	992.41	3058.30

(b) Bank balances other than cash and cash equivalents

	As at 31-Mar-21	As at 31-Mar-20
At amortised cost		
Earmarked balances with banks:		
- unpaid dividend and preference share redemption accounts	11.75	5.27
Balances under lien/margin/kept as security:		
- in fixed/margin deposits	58.66	70.58
Other balances:		
- in fixed deposits	5.29	5.00
Total bank balances other than cash and cash equivalents	75.70	80.85

NOTE 13: ASSETS HELD FOR SALE

	As at 31-Mar-21	As at 31-Mar-20
Investments in equity shares (including loan agreed to be converted into equity) of Aqwise Wise Water Technologies Limited (Israel)	3308.21	-
Less: Allowance for bad and doubtful amounts	(2319.87)	-
	988.34	-
Freehold land	-	3.05
Total assets held for sale	988.34	3.05

The activities of Aqwise Wise Water Technologies Ltd. ("Aqwise"), an associate of the Company, based in Israel, has been severely impacted due to the Covid-19 pandemic. The existing shareholders of Aqwise, including the Company, have accordingly agreed to divest their entire equity stake in favour of G.E.S. Global Environmental Solutions Ltd. ("GES") under an agreement dated 25 March 2021. Under the terms of the agreement with GES and understanding arrived at between the existing shareholders of Aqwise:

- (a) loan of USD 2.50 million advanced by the existing shareholders to Aqwise (including USD 2.35 million advanced by the Company), shall be repaid in full along with due interest. Other loans aggregating USD 2.46 million advanced by existing shareholders (including USD 0.4 million advanced by the Company) shall be converted into equity;
- (b) the existing shareholders shall divest their entire shareholding (including those arising from conversion of loan as stated above) in favour of GES. The shares shall be transferred on the Closing Date (as defined in the agreement) upon receipt of necessary approvals and completion of certain other formalities. The consideration for transfer of shares shall be approximately USD 2.4 million (net, after deduction of certain agreed expenses) to be held in an escrow account and which shall be released after the expiry of 18 months ("escrow period"). GES shall, during the escrow period, be entitled to set-off

Notes to the Standalone Financial Statements

for the year ended March 31, 2021

(All amounts in ₹ lakhs, unless otherwise stated)

against the escrow amount, any indemnification claim which it may have under the agreement as well as to the extent that it is required to fund Aqwise beyond the amount as specified under the agreement. In case no such set-off adjustments occur, the Company expects to receive approximately USD 1.35 million as its share out of the escrow amount USD 2.4 million;

- (c) The existing shareholders shall also be entitled to receive certain graded earn-outs, in the nature of contingent receipts, which are subject to Aqwise and/or one of its subsidiary company achieving certain specified financial targets in future periods. The earn-outs receivable, if any, shall not however exceed in the aggregate USD 17.50 million.

Consequent to the aforesaid, the Company has classified its equity investment held in Aqwise (along with the loan which has been agreed to be converted into equity) as "Assets held for sale". The Company has provided for an impairment loss of ₹ 2319.87 lakhs during the year against the carrying cost of investments and the loan (including interest receivable thereon). In arriving at the impairment loss, the contingent receipts as per (c) above have not been considered. Such investment does not form part of any segment assets.

Freehold land above represents carrying value of land situated in Gujarat intended to be disposed of by the Company. The Company had entered into an agreement to sell such land in the previous year and had also received advance of ₹ 10 lakhs (refer note 19) in terms of such agreement to sell. The Company has transferred the title of such land during the year. The asset does not form part of any segment assets. No impairment loss was recognised on reclassification of the land as held for sale (refer note 4) as the contractual sale price of such land was higher than the carrying amount.

NOTE 14: SHARE CAPITAL

	As at 31-Mar-21		As at 31-Mar-20	
	Number of shares	Amount	Number of shares	Amount
Authorised				
Equity shares of ₹ 1 each	50,00,00,000	5000.00	50,00,00,000	5000.00
Preference shares of ₹ 10 each	2,00,00,000	2000.00	2,00,00,000	2000.00
		7000.00		7000.00
Issued				
Equity shares of ₹ 1 each	24,17,63,110	2417.63	24,79,53,110	2479.53
Subscribed and Paid Up				
Equity shares of ₹ 1 each, fully paid up	24,17,55,110	2417.55	24,79,45,110	2479.45
Add: Paid up value of equity shares of ₹ 1 each forfeited	8,000	0.02	8,000	0.02
		2417.57		2479.47

(i) Movements in equity share capital

	Number of shares	Amount
As at 31 March 2019	25,79,45,110	2579.45
Extinguishment of shares upon buy-back (see (iv) below)	(1,00,00,000)	(100.00)
As at 31 March 2020	24,79,45,110	2479.45
Extinguishment of shares upon buy-back (see (iv) below)	(61,90,000)	(61.90)
As at 31 March 2021	24,17,55,110	2417.55

Notes to the Standalone Financial Statements

for the year ended March 31, 2021

(All amounts in ₹ lakhs, unless otherwise stated)

(ii) Terms and rights attached to equity shares

The Company has only one class of equity shares with a par value of ₹ 1/- per share. The holder of equity shares is entitled to one vote per share. The Company declares and pays dividends in Indian rupees. The dividend proposed by the Board of Directors is subject to the approval of the shareholders in the ensuing Annual General Meeting.

In the event of liquidation of the Company, the holders of equity shares are entitled to receive the remaining assets of the Company, after meeting all liabilities and distribution of all preferential amounts, in proportion to their shareholding.

(iii) Details of shareholders holding more than 5% shares in the Company

	As at 31-Mar-21		As at 31-Mar-20	
	Number of shares	% holding	Number of shares	% holding
Dhruv M. Sawhney	3,77,33,691	15.61	3,86,50,774	15.59
Rati Sawhney	1,75,10,356	7.24	1,79,35,928	7.23
STFL Trading and Finance Private Limited	7,77,39,178	32.16	7,96,31,128	32.12
Nikhil Sawhney	1,43,67,837	5.94	1,47,17,033	5.94
Tarun Sawhney	1,38,20,236	5.72	1,41,56,123	5.71

(iv) Buy-back of equity shares

During the year, the Company has completed buy-back of 6,190,000 (31 March 2020: 10,000,000) equity shares of ₹ 1/- each [representing 2.5% (31 March 2020: 3.88%) of total pre buy-back paid up equity share capital of the Company] from the shareholders of the Company on a proportionate basis, through the tender offer route under the Securities and Exchange Board of India (Buy-back of Securities), Regulations 2018, at a price of ₹ 105 (31 March 2020: ₹ 100) per equity share for an aggregate amount of ₹ 6499.50 lakhs (31 March 2020: ₹ 10000 lakhs). Accordingly, the Company has extinguished 6,190,000 (31 March 2020: 10,000,000) fully paid up equity shares of ₹ 1 each (in dematerialized form) and the fully paid up equity share capital of the Company (post extinguishment) is 241,755,110 (31 March 2020: 247,945,110) shares of ₹ 1/- each. The Company has funded the buy-back (including transaction costs incurred in relation thereto) from its securities premium. In accordance with section 69 of the Companies Act, 2013, the Company has transferred an amount of ₹ 61.90 lakhs (31 March 2020: ₹ 100 lakhs) to capital redemption reserve which is equal to the nominal value of the shares bought back, as an appropriation from securities premium.

NOTE 15: OTHER EQUITY

	As at 31-Mar-21	As at 31-Mar-20
Capital redemption reserve	559.30	497.40
Capital reserve	2855.85	2855.85
Securities premium	8375.55	16419.17
Amalgamation reserve	926.34	926.34
General reserve	49212.72	49212.72
Molasses storage fund reserve	181.20	140.71
Retained earnings	81795.19	54533.68
Total other equity	143906.15	124585.87

Notes to the Standalone Financial Statements

for the year ended March 31, 2021

(All amounts in ₹ lakhs, unless otherwise stated)

(i) Capital redemption reserve

	Year ended 31-Mar-21	Year ended 31-Mar-20
Opening balance	497.40	397.40
Transferred from securities premium on buy-back of equity shares [refer note 14(iv)]	61.90	100.00
Closing balance	559.30	497.40

Capital redemption reserve upto 31 March 2019 was created consequent to redemption of preference share capital, as required under the provisions of the Companies Act, 1956. Consequent to the buy-back of equity shares, the Company has recognised capital redemption reserve from its securities premium at an amount equal to the nominal amount of equity shares bought back. This reserve shall be utilised in accordance with the provisions of Companies Act, 2013.

(ii) Capital reserve

	Year ended 31-Mar-21	Year ended 31-Mar-20
Opening balance	2855.85	2855.85
Movement during the year	-	-
Closing balance	2855.85	2855.85

Capital reserve majorly comprises reserve created consequent to business combination in earlier years, in accordance with the accounting standards then prevailing.

(iii) Securities premium

	Year ended 31-Mar-21	Year ended 31-Mar-20
Opening balance	16419.17	26546.93
Amount utilised for buy-back of equity shares [refer note 14(iv)]	(6437.60)	(9900.00)
Transferred to capital redemption reserve on buy-back of equity shares [refer note 14(iv)]	(61.90)	(100.00)
Transaction costs related to buy-back of equity shares [refer note 14(iv)]	(87.68)	(127.76)
Tax paid on buy-back of equity shares [refer note 14(iv)]	(1456.44)	-
Closing balance	8375.55	16419.17

Securities premium is used to record the premium received on issue of shares and is utilised in accordance with the provisions of the Companies Act, 2013. The Company has utilised securities premium for buy-back of its equity shares [refer note 14(iv)].

(iv) Amalgamation reserve

	Year ended 31-Mar-21	Year ended 31-Mar-20
Opening balance	926.34	926.34
Movement during the year	-	-
Closing balance	926.34	926.34

Amalgamation reserve was created consequent to business combinations in past in accordance with the accounting standards then prevailing.

Notes to the Standalone Financial Statements

for the year ended March 31, 2021

(All amounts in ₹ lakhs, unless otherwise stated)

(v) General reserve

	Year ended 31-Mar-21	Year ended 31-Mar-20
Opening balance	49212.72	49212.72
Movement during the year	-	-
Closing balance	49212.72	49212.72

General reserve represents amount kept by the Company out of its profits for future purposes. It is not earmarked for any specific purpose.

(vi) Molasses storage fund reserve

	Year ended 31-Mar-21	Year ended 31-Mar-20
Opening balance	140.71	216.36
Amount transferred from retained earnings	40.49	21.60
Amount transferred to retained earnings	-	(97.25)
Closing balance	181.20	140.71

Molasses storage fund reserve is created and maintained under the provisions of the Uttar Pradesh Sheera Niyam, 1964 (U.P. Act No. XXIV of 1964) and is to be utilised for the provision and maintenance of adequate storage facilities for molasses. Fixed deposit of ₹ 244.27 lakhs (31 March 2020: ₹ 195.89 lakhs) is earmarked against molasses storage fund (refer note 9).

(vii) Retained earnings

	Year ended 31-Mar-21	Year ended 31-Mar-20
Opening balance	54533.68	25093.73
Net profit for the year	27330.86	32748.52
Other comprehensive income arising from the remeasurement of defined benefit obligation net of income tax	(28.86)	(96.19)
Withdrawn from molasses storage fund reserve	-	97.25
Transfer to molasses storage fund reserve	(40.49)	(21.60)
Dividends paid	-	(2727.40)
Dividend distribution tax	-	(560.63)
Closing balance	81795.19	54533.68

(a) Retained earnings represents undistributed profits of the Company which can be distributed to its equity shareholders in accordance with the provisions of the Companies Act, 2013.

Notes to the Standalone Financial Statements

for the year ended March 31, 2021

(All amounts in ₹ lakhs, unless otherwise stated)

(b) Details of dividend distributions made and proposed:

	Year ended 31-Mar-21	Year ended 31-Mar-20
Cash dividends on equity shares declared and paid:		
Interim dividend for the year ended 31 March 2021: Nil [31 March 2020: 110% (₹ 1.10 per equity share of ₹ 1/- each)]	-	2727.40
Dividend distribution tax on interim dividend	-	560.63
Total cash dividends on equity shares declared and paid	-	3288.03
Cash dividends on equity shares proposed:		
Final dividend for the year ended 31 March 2021: 175% (₹ 1.75 per equity share of ₹ 1/- each) [31 March 2020: Nil]	4230.71	-

Proposed dividends on equity shares are subject to approval at the annual general meeting and are not recognised as a liability as at 31 March.

NOTE 16: NON-CURRENT BORROWINGS

	As at 31-Mar-21		As at 31-Mar-20	
	Current maturities	Non-current	Current maturities	Non-current
Secured- at amortised cost				
Term loans				
- from banks	4550.17	10509.40	8127.90	22284.07
- from other parties	5910.05	15558.86	6178.82	22075.57
	10460.22	26068.26	14306.72	44359.64
Less: Amount disclosed under the head "Other financial liabilities- current" (refer note 17)	(10460.22)	-	(14306.72)	-
Total non-current borrowings	-	26068.26	-	44359.64

Notes to the Standalone Financial Statements

for the year ended March 31, 2021

(All amounts in ₹ lakhs, unless otherwise stated)

NOTE 16: NON-CURRENT BORROWINGS (CONTD.) (i) Details of long term borrowings of the Company

	Amount outstanding as at		Interest rate	Number of instalments		Terms of Repayment	Nature of Security
	31-Mar-21	31-Mar-20		31-Mar-21	31-Mar-20		
Secured- at amortised cost							
Term loans from banks (₹ loans)							
1	6238.59	7673.59		13	16	Equal quarterly instalments from September 2020 to June 2024.	Secured by first pari-passu charge created / to be created by equitable mortgage on immovable assets and hypothecation of all moveable assets, both present and future of the Company and second pari-passu charge on current assets of the Company.
2	4041.13	4978.97		13	16	Equal quarterly instalments from September 2020 to June 2024.	Secured by first pari-passu charge created / to be created by equitable mortgage on immovable assets and hypothecation of all moveable assets, both present and future of the Company and second pari-passu charge on current assets of the Company.
3	4060.59	4996.91	At MCLR plus applicable spread. The interest rate as on 31.03.2021 range between 7.40% to 8.55% per annum.	13	16	Equal quarterly instalments from September 2020 to June 2024.	Secured by first pari-passu charge created / to be created by equitable mortgage on immovable assets and hypothecation of all moveable assets, both present and future of the Company and second pari-passu charge on current assets of the Company.
4	-	12485.48		Nil	24	-	Secured by first pari-passu charge created / to be created by equitable mortgage on immovable assets and hypothecation of all moveable assets, both present and future of the Company and second pari-passu charge on current assets of the Company.
5	495.00	-		16	-	Equal quarterly instalments from June 2022 to March 2026.	Secured by first pari-passu charge created / to be created by equitable mortgage on immovable assets and hypothecation of all moveable assets, both present and future of the Company and second pari-passu charge on current assets of the Company.

Notes to the Standalone Financial Statements

for the year ended March 31, 2021

(All amounts in ₹ lakhs, unless otherwise stated)

	Amount outstanding as at		Interest rate	Number of instalments		Terms of Repayment	Nature of Security
	31-Mar-21	31-Mar-20		31-Mar-21	31-Mar-20		
6 Axis Bank (Vehicle loan)	200.32	221.72	At fixed rates	2 to 51	1 to 56	Equated monthly	Secured by hypothecation of vehicles acquired under the respective vehicle loans.
7 PNB Bank (Vehicle loan)	11.81	18.10	ranging from			instalments	
8 Yes Bank (Vehicle loan)	12.13	37.20	7.60% to 9.99% p.a.				
Total term loans from banks	15059.57	30411.97					
Term loans from other parties (₹ loans)	15059.57	30411.97					
1 Daimler Financial Services Pvt. Ltd. (Vehicle loan)	95.64	119.71	8.91% p.a.	10	4 to 22 months	Equated monthly instalments	Secured by hypothecation of vehicles acquired under the respective vehicle loans.
2 Govt. of Uttar Pradesh through RBL Bank Ltd. under SEFASU 2018 *	21373.27	28134.68	5% p.a.	38	51	Equal monthly instalments upto June 2024	Secured by first pari-passu charge on the fixed assets of the Company
Total term loans from other parties	21468.91	28254.39					
Total loans	36528.48	58666.36					

*Loans with interest subvention or below market rate under various schemes of the Government, refer note 43.

Notes to the Standalone Financial Statements

for the year ended March 31, 2021

(All amounts in ₹ lakhs, unless otherwise stated)

NOTE 17: OTHER FINANCIAL LIABILITIES

	As at 31-Mar-21		As at 31-Mar-20	
	Current	Non-current	Current	Non-current
At amortised cost				
Current maturities of long-term borrowings (refer note 16)	10460.22	-	14306.72	-
Accrued interest	89.79	-	208.80	-
Capital creditors (see (i) below)	1149.77	-	1894.29	-
Employee benefits & other dues payable	3029.02	-	2725.94	-
Lease liabilities	352.85	972.68	544.87	1221.63
Security deposits (see (ii) below)	446.86	-	391.14	-
Unpaid dividends (see (iii) below)	11.73	-	5.25	-
Total other financial liabilities at amortised cost [A]	15540.24	972.68	20077.01	1221.63
At fair value through Profit or Loss (FVTPL) (refer note 42)				
Derivatives financial instruments carried at fair value				
- Foreign exchange forward contracts	-	-	2.19	-
Total other financial liabilities at FVTPL [B]	-	-	2.19	-
Total other financial liabilities ([A]+[B])	15540.24	972.68	20079.20	1221.63

- (i) Capital creditors as at 31 March 2021 include ₹ 24.74 lakhs (31 March 2020 : Nil) outstanding balance of micro enterprises and small enterprises (refer note 47).
- (ii) Security deposits as at 31 March 2021 include ₹ 364 lakhs (31 March 2020 : ₹ 314 lakhs) deposits from sugar selling agents which are interest bearing subject to fulfillment of terms and conditions. These deposits are repayable on cessation of contractual arrangements. Interest payable is normally settled annually.
- (iii) There are no amounts as at the end of the year which are due and outstanding to be credited to the Investors Education and Protection Fund.

NOTE 18: PROVISIONS

	As at 31-Mar-21		As at 31-Mar-20	
	Current	Non-current	Current	Non-current
Provision for employee benefits				
Gratuity (refer note 38)	482.67	4074.09	333.28	3794.78
Compensated absences	543.86	1101.25	509.39	998.56
Other Provisions				
Warranty	2375.07	-	1855.08	-
Cost to completion	220.41	-	385.76	-
Arbitration/Court case claims	105.65	-	99.44	-
Total provisions	3727.66	5175.34	3182.95	4793.34

Notes to the Standalone Financial Statements

for the year ended March 31, 2021

(All amounts in ₹ lakhs, unless otherwise stated)

(i) Information about individual provisions and significant estimates

(a) Warranty

The Company provides warranties on certain products, undertaking to repair or replace the items that fail to perform satisfactorily during the warranty period. Provisions made represent the amount of expected cost of meeting such obligations of rectifications / replacements based on best estimate considering the historical warranty claim information and any recent trends that may suggest future claims could differ from historical amounts. It also includes provisions made towards contractual obligations to replace certain parts under an Operation and Maintenance contract. The timing of the outflows is expected to be within a period of two years.

(b) Cost to completion

The provision represents costs of materials and services required for integration of water treatment package at the site (the revenue of which has been fully recognised), prior to commissioning.

(c) Arbitration / Court-case Claims

Represents the provision made towards certain claims awarded against the Company in legal proceedings which have been challenged by the Company before appropriate authorities. The timing of the outflows is uncertain.

(ii) Movement in provisions

Movement in each class of provision are set out below:

	Year ended 31-Mar-21			Year ended 31-Mar-20		
	Warranty	Cost to completion	Arbitration/ Court case claims	Warranty	Cost to completion	Arbitration/ Court case claims
Balance at the beginning of the year	1855.08	385.76	99.44	1307.65	1024.47	93.23
Additional provisions recognised	539.25	145.00	6.21	577.53	299.65	6.21
Amounts used during the year	(19.26)	(310.35)	-	(16.84)	(838.36)	-
Unused amounts reversed during the year	-	-	-	(13.26)	(100.00)	-
Balance at the end of the year	2375.07	220.41	105.65	1855.08	385.76	99.44

NOTE 19: OTHER LIABILITIES

	As at 31-Mar-21		As at 31-Mar-20	
	Current	Non-current	Current	Non-current
Revenue received in advance				
Deferred revenue arising from government grant related to assets (refer note 43)	-	141.46	-	141.45
Deferred revenue arising from government grant related to income (refer note 43)	858.92	821.14	1125.25	1680.07
Amount due to customers under construction contracts [refer note 10(ii)]	8080.18	-	5873.72	-

Notes to the Standalone Financial Statements

for the year ended March 31, 2021

(All amounts in ₹ lakhs, unless otherwise stated)

	As at 31-Mar-21		As at 31-Mar-20	
	Current	Non-current	Current	Non-current
Other advances				
Advance from customers	4672.67	-	5330.66	-
Advance against assets held for sale (refer note 13)	-	-	10.00	-
Others				
Statutory remittances	2659.26	-	2766.19	-
Miscellaneous other payables	155.10	-	250.13	-
Total other liabilities	16426.13	962.60	15355.95	1821.52

NOTE 20: CURRENT BORROWINGS

	As at 31-Mar-21	As at 31-Mar-20
Secured- at amortised cost		
Repayable on demand		
- Cash credits/working capital demand loans/soft loans from banks (see (i) below)	56157.43	94343.87
Total current borrowings	56157.43	94343.87

- (i) Above loans are secured by pledge/hypothecation of the stock-in-trade, raw material, stores and spare parts, work-in-progress and trade receivables and second charge created/to be created on the properties of all the Engineering units and immovable property at New Delhi and third charge on the properties of Sugar, Co-Generation and Distillery units of the Company on pari-passu basis. Interest rates on the above loans outstanding as at the year end majorly ranges between 4.95% to 8.00% (weighted average interest rate : 5.85% p.a.).

NOTE 21: TRADE PAYABLES

	As at 31-Mar-21	As at 31-Mar-20
Trade payables (at amortised cost)		
- Total outstanding dues of micro enterprises and small enterprises (refer note 47)	538.57	6.73
- Total outstanding dues of creditors other than micro enterprises and small enterprises	61874.41	75633.30
Total trade payables	62412.98	75640.03

Notes to the Standalone Financial Statements

for the year ended March 31, 2021

(All amounts in ₹ lakhs, unless otherwise stated)

NOTE 22: INCOME TAX BALANCES

	As at 31-Mar-21		As at 31-Mar-20	
	Current	Non-current	Current	Non-current
Income tax assets				
Tax refund receivable (net)	-	1117.58	-	4336.79
	-	1117.58	-	4336.79
Income tax liabilities				
Provision for income tax (net)	1897.65	-	789.84	-
	1897.65	-	789.84	-

NOTE 23: DEFERRED TAX BALANCES

	As at 31-Mar-21	As at 31-Mar-20
Deferred tax assets	3306.42	8319.33
Deferred tax liabilities	(13390.96)	(13268.36)
Net deferred tax assets/(liabilities)	(10084.54)	(4949.03)

(i) Movement in deferred tax balances

For the year ended 31 March 2021

	Opening balance	Recognised in profit or loss	Recognised in OCI	Closing balance
Tax effect of items constituting deferred tax assets/(liabilities)				
Deferred tax assets				
Difference in carrying values of investment property	190.86	(24.28)	-	166.58
Liabilities and provisions tax deductible only upon payment/actual crystallisation				
- Employee benefits	1663.90	(124.94)	15.50	1554.46
- Statutory taxes and duties	180.43	(4.00)	-	176.43
- Other contractual provisions	725.42	(37.90)	-	687.52
Impairment provisions of financial assets made in books, but tax deductible only on actual write-off	592.67	91.33	-	684.00
Other temporary differences	40.71	(3.28)	-	37.43
Unused tax credits	4925.34	(4925.34)	-	-
	8319.33	(5028.41)	15.50	3306.42
Deferred tax liabilities				
Difference in carrying values of property, plant & equipment and intangible assets	(13268.36)	(122.60)	-	(13390.96)
	(13268.36)	(122.60)	-	(13390.96)
Net deferred tax assets/(liabilities)	(4949.03)	(5151.01)	15.50	(10084.54)

Notes to the Standalone Financial Statements

for the year ended March 31, 2021

(All amounts in ₹ lakhs, unless otherwise stated)

For the year ended 31 March 2020

	Opening balance	Recognised in profit or loss	Recognised in OCI	Closing balance
Tax effect of items constituting deferred tax assets/(liabilities)				
Deferred tax assets				
Difference in carrying values of investment property	278.52	(87.66)	-	190.86
Liabilities and provisions tax deductible only upon payment/actual crystallisation				
- Employee benefits	1955.90	(343.67)	51.67	1663.90
- Statutory taxes and duties	231.39	(50.96)	-	180.43
- Other contractual provisions	863.87	(138.45)	-	725.42
Impairment provisions of financial assets made in books, but tax deductible only on actual write-off	660.93	(68.26)	-	592.67
Other temporary differences	56.77	(16.06)	-	40.71
Unused tax credits	9017.58	(4092.24)	-	4925.34
	13064.96	(4797.30)	51.67	8319.33
Deferred tax liabilities				
Difference in carrying values of property, plant & equipment and intangible assets	(16303.63)	3035.27	-	(13268.36)
	(16303.63)	3035.27	-	(13268.36)
Net deferred tax assets/(liabilities)	(3238.67)	(1762.03)	51.67	(4949.03)

(ii) Unrecognised deductible temporary differences, unused tax losses and unused tax credits:

Deferred tax assets have not been recognised in respect of following items, because it is not probable that future taxable profit will be available against which the Company can use the benefit therefrom.

	As at 31-Mar-21	As at 31-Mar-20
Tax effect on unused tax losses (long term capital loss) (see table below for expiry)	0.41	12.79
Net deferred tax assets/(liabilities)	0.41	12.79
Expiry profile of unrecognised unused tax losses		
Unused tax losses shall expire on -		
(i) Long term capital loss		
March 31, 2021	-	11.77
March 31, 2028	-	0.45
(ii) Short term capital loss		
March 31, 2025	0.16	0.23
March 31, 2026	0.25	0.34
	0.41	12.79

Notes to the Standalone Financial Statements

for the year ended March 31, 2021

(All amounts in ₹ lakhs, unless otherwise stated)

NOTE 24 : REVENUE FROM OPERATIONS

	Year ended 31-Mar-21	Year ended 31-Mar-20
Sale of products [refer note 37(vii)]		
Finished goods	425887.37	388704.38
Stock-in-trade	2132.59	1859.51
Sale of services		
Erection and commissioning	-	4.66
Servicing	232.18	194.66
Operation and maintenance	2578.00	2978.25
Construction contract revenue	19833.91	24707.01
Other operating revenue		
Subsidy from Central Government (refer note 43)	18579.03	23472.11
Income from sale of renewable energy certificates	16.06	254.00
Income from scrap	61.35	182.60
Total revenue from operations	469320.49	442357.18

(i) Unsatisfied long-term construction contracts:

The transaction price allocated to all contracts (viz. water/wastewater treatment and turnkey projects relating to steam turbine) that are partially or fully unsatisfied as at reporting date alongwith expected period of its revenue recognition, are as follows:

	As at 31-Mar-21 [#]	As at 31-Mar-20 [#]
Within one year	17112.44	25562.44
More than one year	9108.41	20296.04
Total	26220.85	45858.48

[#]As permitted under Ind AS 115, all contracts having original expected duration of one year or less or which are billed based on time incurred are not disclosed.

(ii) Reconciliation of revenue recognised with contract price:

	As at 31-Mar-21	As at 31-Mar-20
Contract price	469466.67	442444.29
Adjustments for Discounts/ Commissions to Customers	(146.18)	(87.11)
Total revenue from operations	469320.49	442357.18

Notes to the Standalone Financial Statements

for the year ended March 31, 2021

(All amounts in ₹ lakhs, unless otherwise stated)

NOTE 25: OTHER INCOME

	Year ended 31-Mar-21	Year ended 31-Mar-20
Interest income		
Interest income from financial assets carried at amortised cost	635.54	237.97
Interest income from investments carried at FVTPL	0.17	2.60
Interest income from others	321.84	12.73
	957.55	253.30
Dividend income		
Dividend income from equity investments	2.84	356.00
	2.84	356.00
Other non-operating income (net of expenses directly attributable to such income)		
Rental income [refer note 4(ii)]	33.85	45.11
Subsidy from Central Government (refer note 43)	200.64	1224.58
Miscellaneous income	1537.38	1165.91
	1771.87	2435.60
Other gains/(losses)		
Net fair value gains/(losses) on investments	169.36	(61.77)
Net gains/(losses) on derivatives	133.29	(14.16)
Net foreign exchange rate fluctuation gains	-	78.36
Credit balances written back	131.63	208.16
Net profit/(loss) on sale / redemption of investments	0.02	0.10
Net reversal of impairment loss allowance on other non financial assets (31 March 2020 :includes amounts written off ₹ 17.36 lakhs) (refer note 10)	-	16.20
Net reversal of provision for non moving / obsolete inventory (refer note 11)	6.00	74.29
Provision for cost to completion reversed (net) (refer note 18)	165.35	638.71
Excess provision of expenses reversed	92.24	21.91
	697.89	961.80
Total other income	3430.15	4006.70

NOTE 26: COST OF MATERIALS CONSUMED

	Year ended 31-Mar-21	Year ended 31-Mar-20
Stock at the beginning of the year	2988.14	2144.99
Add: Purchases	322396.30	301919.31
Less: Amount capitalised (included in the cost of property, plant and equipment)	(9.52)	(8.34)
Less: Stock at the end of the year	(3883.10)	(2988.14)
Total cost of materials consumed (refer note 43)	321491.82	301067.82

Notes to the Standalone Financial Statements

for the year ended March 31, 2021

(All amounts in ₹ lakhs, unless otherwise stated)

NOTE 27: PURCHASES OF STOCK-IN-TRADE

	Year ended 31-Mar-21	Year ended 31-Mar-20
Petroleum goods	2174.74	2210.00
Other consumer goods	25.99	19.42
Total purchases of stock-in-trade	2200.73	2229.42

NOTE 28: CHANGES IN INVENTORIES OF FINISHED GOODS, STOCK-IN-TRADE AND WORK-IN-PROGRESS

	Year ended 31-Mar-21	Year ended 31-Mar-20
Inventories at the beginning of the year:		
Finished goods	180701.02	201739.45
Stock-in-trade	28.41	31.65
Work-in-progress	3406.72	4247.69
Total inventories at the beginning of the year	184136.15	206018.79
Inventories at the end of the year:		
Finished goods	161840.87	180701.02
Stock-in-trade	44.89	28.41
Work-in-progress	2609.73	3406.72
Total inventories at the end of the year	164495.49	184136.15
Add/(Less): Impact of excise duty on finished goods	273.60	-
Total changes in inventories of finished goods, stock-in-trade and work-in-progress	19914.26	21882.64

NOTE 29: EMPLOYEE BENEFITS EXPENSE

	Year ended 31-Mar-21	Year ended 31-Mar-20
Salaries and wages	24107.14	22464.36
Contribution to provident and other funds (refer note 38)	2288.99	2376.68
Staff welfare expenses	640.13	704.57
	27036.26	25545.61
Less: Amount capitalised (included in the cost of property, plant and equipment)	(30.36)	(47.81)
Total employee benefits expense	27005.90	25497.80

Notes to the Standalone Financial Statements

for the year ended March 31, 2021

(All amounts in ₹ lakhs, unless otherwise stated)

NOTE 30: FINANCE COSTS

	Year ended 31-Mar-21	Year ended 31-Mar-20
Interest costs		
- Interest on loans with interest subvention (refer note 43)	1595.52	1132.33
- Interest on loans with below-market rate of interest (refer note 43)	1348.56	1696.46
- Interest on other borrowings	1994.60	4859.23
- Interest on lease liabilities	147.12	185.93
- Other interest expense	46.25	94.66
Total interest expense on financial liabilities not classified as at FVTPL	5132.05	7968.61
Less : Amount capitalised (included in the cost of property, plant and equipment)	(0.51)	(50.20)
	5131.54	7918.41
Exchange differences regarded as an adjustment to borrowing costs	-	5.17
Other borrowing costs		
- Loan monitoring and administration charges	12.16	8.12
Total finance costs	5143.70	7931.70

NOTE 31: DEPRECIATION AND AMORTISATION EXPENSE

	Year ended 31-Mar-21	Year ended 31-Mar-20
Depreciation of property, plant and equipment (refer note 3)	7860.57	7458.78
Amortisation of intangible assets (refer note 5)	50.28	31.83
	7910.85	7490.61
Less: Amount capitalised (included in the cost of property, plant and equipment)	(2.09)	(1.49)
Total depreciation and amortisation expense	7908.76	7489.12

NOTE 32: IMPAIRMENT LOSS ON FINANCIAL ASSETS (INCLUDING REVERSALS OF IMPAIRMENT LOSSES)

	Year ended 31-Mar-21	Year ended 31-Mar-20
Bad debts written off - trade receivables carried at amortised cost	75.06	315.06
Impairment loss allowance on trade receivables (net of reversals) (refer note 7)	309.65	546.41
Total impairment loss on financial assets (including reversals of impairment losses)	384.71	861.47

Notes to the Standalone Financial Statements

for the year ended March 31, 2021

(All amounts in ₹ lakhs, unless otherwise stated)

NOTE 33: OTHER EXPENSES

	Year ended 31-Mar-21	Year ended 31-Mar-20
Stores and spares consumed	4031.44	3520.40
Power and fuel	2329.25	1575.37
Design and engineering charges	53.32	71.49
Cane development expenses	186.74	164.34
Machining/fabrication expenses	100.81	86.84
Erection and commissioning expenses	999.38	855.68
Civil construction charges	3581.26	4644.92
Packing and stacking expenses	4463.68	4007.31
Repairs and maintenance		
- Machinery	5234.94	4815.68
- Building	823.07	728.34
- Others	378.95	345.37
Factory/operational expenses	2708.66	2648.81
Travelling and conveyance	1104.99	1412.89
Rent expense (refer note 44)	195.68	164.72
Rates and taxes	381.64	336.46
Insurance	684.96	467.73
Directors' fee	69.95	68.65
Directors' commission	96.00	72.50
Legal and professional expenses	1560.87	1025.33
Security service expenses	1654.00	1549.45
Net impairment loss allowance on contract assets (refer note 10)	59.36	24.91
Bad debts written off - other non financial assets (net of reversal of impairment loss allowance of ₹ 0.12 lakhs) (refer note 10)	9.88	-
Net foreign exchange rate fluctuation losses	4.06	-
Warranty expenses [includes provision for warranty (net) ₹ 539.25 lakhs (31 March 2020 : ₹ 564.27 lakhs) (refer note 18)]	540.56	596.44
Provision for Arbitration/Court case claims (refer note 18)	6.21	6.21
Payment to Auditors (see (i) below)	68.96	73.34
Corporate social responsibility expenses (see (ii) below)	416.69	141.20
Loss on sale /write off of inventory	15.77	200.44
Loss on sale / write off / impairment of property, plant and equipment	423.49	19.86
Expenses relating to third party exports under MAEQ scheme	28.75	-
Selling commission	877.75	878.53
Royalty	242.60	269.65
Outward freight and forwarding (refer note 43)	5061.83	4685.85
Other selling expenses	272.93	260.90
Miscellaneous expenses	1777.43	1890.92
Less: Amount capitalised (included in the cost of property, plant and equipment)	(32.97)	(69.11)
Total other expenses	40412.89	37541.42

Notes to the Standalone Financial Statements

for the year ended March 31, 2021

(All amounts in ₹ lakhs, unless otherwise stated)

(i) Detail of payment to auditors

	Statutory Auditors		Cost Auditors	
	Year ended 31-Mar-21	Year ended 31-Mar-20	Year ended 31-Mar-21	Year ended 31-Mar-20
Audit fee	44.25	46.30	4.48	4.48
Limited review fee	16.20	16.95	-	-
Other services (Certification) *	3.45	1.80	0.33	0.65
Reimbursement of expenses	0.25	2.78	-	0.38
Total payment to auditors	64.15	67.83	4.81	5.51

*This amount is exclusive of ₹ 3 lakhs (31 March 2020: ₹ 3 lakhs) paid to the statutory auditors towards certificates in connection with buy-back of shares. The same has been adjusted against securities premium, as these are transaction costs pertaining to buy-back [refer note 14(iv)].

(ii) Corporate Social Responsibility (CSR)

(a) The Company has incurred CSR expenses mainly towards promoting education and sports, ensuring environmental sustainability and rural development which are specified in Schedule VII of the Companies Act, 2013.

(b) Detail of CSR expenses:

	Year ended 31-Mar-21	Year ended 31-Mar-20
(a) Gross amount required to be spent during the year	416.69	135.32
(b) Maximum amount approved by the Board to be spent during the year	450.00	141.20
(c) Amount spent during the year on :		
(i) Construction/acquisition of any asset	-	-
(ii) Purposes other than (i) above		
Education, Vocational skills and Livelihood enhancement	104.00	71.09
Environmental sustainability and conservation of natural resources	60.00	-
Healthcare	58.43	-
Promoting sports	5.00	5.00
Quality of soil	172.86	53.27
Contribution to Prime Minister National Relief Fund	40.00	-
Rural Development	-	11.84
	440.29	141.20
Less: Excess spent during the year, carried forward to next year	23.60	-
Net amount recognised in the statement of profit and loss	416.69	141.20

Notes to the Standalone Financial Statements

for the year ended March 31, 2021

(All amounts in ₹ lakhs, unless otherwise stated)

NOTE 34: EXCEPTIONAL ITEMS

	Year ended 31-Mar-21	Year ended 31-Mar-20
Profit on sale of land	136.73	282.04
Net impairment loss allowance on investments in equity shares (including loan agreed to be converted into equity) of Aqwise Wise Water Technologies Limited (Israel), an associate of the Company (refer note 13)	(2319.87)	-
Total exceptional items	(2183.14)	282.04

NOTE 35: INCOME TAX EXPENSE

(i) Income tax recognised in profit or loss

	Year ended 31-Mar-21	Year ended 31-Mar-20
Current tax		
In respect of the current year	10695.93	7644.44
In respect of earlier years	9.33	(10.46)
Total current tax expense	10705.26	7633.98
Deferred tax		
In respect of current year origination and reversal of temporary differences*	5151.01	1762.03
Total deferred tax expense	5151.01	1762.03
Total income tax expense recognised in profit or loss	15856.27	9396.01

* includes utilisation of MAT credit of ₹ 4925.34 lakhs (31 March 2020: ₹ 4092.24 lakhs).

Reconciliation of income tax expense and the accounting profit multiplied by Company's tax rate:

	Year ended 31-Mar-21	Year ended 31-Mar-20
Profit before tax	43187.13	42144.53
Income tax expense calculated at 34.944% (including surcharge and education cess) (2019-20: 34.944%)	15091.31	14726.99
Effect of changes in tax rate #	-	(4059.47)
Effect of income that is exempt from taxation	(46.28)	(222.96)
Effect of income that is taxable at lower rates	(46.33)	1.94
Effect of expenses that are non-deductible in determining taxable profit	1028.98	172.18
Effect of tax incentives and concessions	-	(1568.41)
Effect of changes in tax base of assets not considered in profit or loss (net of reversal of temporary differences)	25.63	285.79
Effect of recognition of deferred tax assets/liabilities due to changes in estimates	(206.37)	70.41
Effect of changes in estimates related to prior years	9.33	(10.46)
Total income tax expense recognised in profit or loss	15856.27	9396.01

#With effect from the financial year commencing from 1 April 2019, in accordance with the provisions of section 115BAA of the Income Tax Act, 1961, domestic companies have an option to pay income tax at a concessional rate by foregoing certain existing exemptions, deductions and credits ("new tax regime"). During the year ended 31 March 2020, the Company had assessed the impact of the newly introduced provisions and had decided to continue with the existing tax structure to claim certain deductions and to ensure that the tax credits that it was entitled to were substantially utilized, before opting for the new tax regime. Further, in accordance with the applicable accounting standard, it remeasured its deferred tax liabilities (net) which were expected to reverse in the future when the Company would have shifted to the new tax regime. Accordingly, the charge of deferred tax for the year ended 31 March 2020 was lower by ₹ 4059.47 lakhs. As at 31 March 2021, the Company has not opted to switch to the new tax regime.

Notes to the Standalone Financial Statements

for the year ended March 31, 2021

(All amounts in ₹ lakhs, unless otherwise stated)

(ii) Income tax recognised in other comprehensive income

	Year ended 31-Mar-21	Year ended 31-Mar-20
Deferred tax related to items recognised in other comprehensive income during the year:		
Remeasurement of defined benefit obligations	(15.50)	(51.67)
Total income tax expense recognised in other comprehensive income	(15.50)	(51.67)
Bifurcation of the income tax recognised in other comprehensive income into:		
Items that will not be reclassified to profit or loss	(15.50)	(51.67)
Items that may be reclassified to profit or loss	-	-
Total income tax expense recognised in other comprehensive income	(15.50)	(51.67)

NOTE 36: EARNINGS PER SHARE

	Year ended 31-Mar-21	Year ended 31-Mar-20
Profit for the year attributable to owners of the Company [A]	27330.86	32748.52
Weighted average number of equity shares for the purposes of basic EPS/ diluted EPS [B]	24,52,99,521	25,16,33,635
Basic earnings per share (face value of ₹ 1 per share) [A/B]	11.14	13.01
Diluted earnings per share (face value of ₹ 1 per share) [A/B]	11.14	13.01

NOTE 37: SEGMENT INFORMATION

(i) Description of segments and principal activities

The operating segments are classified under two major businesses which the Company is engaged in, and are briefly described as under:

Sugar & Allied Business

(a) **Sugar:** The Company is a manufacturer of white crystal sugar, having seven manufacturing plants situated in the states of Uttar Pradesh. The sugar is sold to wholesalers and industrial users. The Company uses its captively produced bagasse, generated as a by-product in the manufacturing of sugar, as a feed stock for generating power and apart from meeting the power and steam requirements of the associated sugar units, also exports power to the state grid. Molasses, another by-product in the manufacturing of sugar, is used as raw material for producing alcohol/ethanol. The Company sells the surplus molasses and bagasse after meeting its captive requirements.

(b) **Distillery:** The Company with its two distilleries having total capacity of 320 kilo-litres per day located at Muzaffarnagar, Uttar Pradesh and Sabitgarh, Uttar Pradesh, uses captive molasses produced in manufacture of sugar as the principal raw material in production of various categories of alcohol. The Company has also, under its Alcoholic Beverages vertical forming part of this segment, started producing country liquor during the current year at its bottling facility in the premises of its existing distillery in Muzaffarnagar, Uttar Pradesh, to facilitate forward integration of distillery operations.

Notes to the Standalone Financial Statements

for the year ended March 31, 2021

(All amounts in ₹ lakhs, unless otherwise stated)

Engineering Business

- (a) **Power transmission:** This business segment is focused on all high speed and niche low speed products - supply of new equipment, after market services and retrofitment of gearboxes, catering to the requirement of power sector as well as other industrial segments. The manufacturing facility is located at Mysore, Karnataka.
- (b) **Water/Wastewater treatment:** The business segment operates from Noida, Uttar Pradesh and provides engineered-to-order process equipment and comprehensive solutions in the water and wastewater management. It operates in EPC segments, HAM projects and O&M.

The 'Other Operations' mainly include selling of own manufactured sugar and trading of jaggery, under the Stores/ Company's brand name and retailing of diesel/petrol through a Company operated fuel station. It also includes a turnkey project relating to steam turbines which was awarded to it pursuant to bids tendered prior to demerger of steam turbine business.

The above reportable segments have been identified based on the significant components of the enterprise for which discrete financial information is available and are reviewed by the Chief operating decision maker (CODM) to assess the performance and allocate resources to the operating segments. During the current year, the Management had, pursuant to a review, combined the cogeneration operations with the sugar operations in accordance with Ind AS 108 'Operating Segments' as the cogeneration activities no longer qualified as a separate operating segment. Accordingly, the figures of the corresponding previous period(s) have been regrouped. Further, the Board has approved to redesignate the 'Gear business' as the 'Power Transmission business', which is a more accurate representation of the present business, and accordingly, the new terminology has been used in the segment information.

There are no geographical segments as the volume of exports is not significant and the major turnover of the Company takes place indigenously. There is no major reliance on a few customers or suppliers.

Notes to the Standalone Financial Statements

for the year ended March 31, 2021

(All amounts in ₹ lakhs, unless otherwise stated)

	SUGAR						ENGINEERING						OTHERS		Eliminations		Total		
	Sugar		Distillery		Total Sugar		Power transmission		Water		Total Engineering		Other Operations						
	Year ended 31-Mar-21	Year ended 31-Mar-20	Year ended 31-Mar-21	Year ended 31-Mar-20	Year ended 31-Mar-21	Year ended 31-Mar-20	Year ended 31-Mar-21	Year ended 31-Mar-20	Year ended 31-Mar-21	Year ended 31-Mar-20	Year ended 31-Mar-21	Year ended 31-Mar-20	Year ended 31-Mar-21	Year ended 31-Mar-20	Year ended 31-Mar-21	Year ended 31-Mar-20	Year ended 31-Mar-21	Year ended 31-Mar-20	Year ended 31-Mar-21
REVENUE																			
From external customers	369923.17	350982.86	54350.99	39095.34	424274.16	390079.20	12960.17	15360.28	25059.77	29280.91	38019.94	44641.19	7026.39	7637.79	-	-	-	46930.49	442357.18
From inter-segments sales	36388.29	28757.82	24.57	21.31	36412.86	28779.13	47.43	61.86	-	6.50	47.43	68.36	117.84	433.15	(36578.13)	(29280.64)	-	-	-
Total revenue from operations	406311.46	379740.68	54375.56	39116.65	460687.02	418857.33	13007.60	15422.14	25059.77	29287.41	38067.37	44709.55	7144.23	8070.94	(36578.13)	(29280.64)	46930.49	442357.18	442357.18
RESULT																			
Segment Profit/(loss)	37449.92	35748.57	10105.42	11054.94	47555.34	46803.51	4090.82	4853.53	1884.07	1349.11	5974.89	6202.64	(45.15)	(47.09)	-	-	-	53485.08	52959.06
Unallocated expenses (Net)																		(3928.66)	(3418.17)
Finance cost																		(5143.70)	(7931.70)
Interest income																		957.55	253.30
Exceptional items																		(2183.14)	282.04
Profit before tax																		43187.13	42444.53
Current tax																		(10705.26)	(7633.99)
Deferred tax																		(5151.01)	(1762.09)
Profit for the year																		27330.86	32748.52

- The accounting policies of the reportable segments are the same as the Company's accounting policies described in note 1.

- Inter-Segment transfers are priced based on competitive market prices or determined to yield a desired margin or agreed on a negotiated basis.

- Segment profit is the Segment revenue less Segment expenses. Segment revenue/expenses includes all revenues/expenses that are attributable to the segments.

- Dividend income, finance income, finance costs, fair value gains & losses on certain financial assets/liabilities, current tax/deferred tax charge are not allocated to individual segments since these are managed/applicable at an overall Company basis.

Notes to the Standalone Financial Statements

for the year ended March 31, 2021

(All amounts in ₹ lakhs, unless otherwise stated)

(iii) Segment assets and liabilities

	SUGAR				ENGINEERING				OTHERS		Eliminations		Total			
	Sugar		Distillery		Total Sugar		Power transmission		Water		Total Engineering		Other Operations			
	Year ended 31-Mar-21	Year ended 31-Mar-20	Year ended 31-Mar-21	Year ended 31-Mar-20	Year ended 31-Mar-21	Year ended 31-Mar-20	Year ended 31-Mar-21	Year ended 31-Mar-20	Year ended 31-Mar-21	Year ended 31-Mar-20	Year ended 31-Mar-21	Year ended 31-Mar-20	Year ended 31-Mar-21	Year ended 31-Mar-20	Year ended 31-Mar-21	
ASSETS																
Segment assets	239116.88	285020.87	46060.18	40520.38	285177.06	325541.25	11812.68	11089.69	35127.12	42150.90	46216.81	46216.81	2020.70	-	328476.29	373776.76
Unallocated assets															17272.94	19823.58
Total assets	239116.88	285020.87	46060.18	40520.38	285177.06	325541.25	11812.68	11089.69	35127.12	42150.90	46216.81	46216.81	2020.70	-	345749.23	393602.34
LIABILITIES																
Segment liabilities	66154.95	76538.36	2873.31	2305.85	69028.26	78864.81	3193.44	2436.49	20458.92	21037.36	22895.41	22895.41	1435.81	-	90639.32	103196.03
Unallocated liabilities															108786.19	163340.97
Total liabilities	66154.95	76538.36	2873.31	2305.85	69028.26	78864.81	3193.44	2436.49	20458.92	21037.36	22895.41	22895.41	1435.81	-	199425.51	266537.00

- The accounting policies of the reportable segments are the same as the Company's accounting policies described in note 1.

- All assets are allocated to reportable segments other than investments, loans, current/deferred tax assets and certain financial assets. Segment assets include all assets that are attributable to the segments.

- All liabilities are allocated to reportable segments other than borrowings, current and deferred tax liabilities and certain financial liabilities. Segment liabilities include all liabilities that are attributable to the segments.

Notes to the Standalone Financial Statements

for the year ended March 31, 2021

(All amounts in ₹ lakhs, unless otherwise stated)

	SUGAR						ENGINEERING						OTHERS		Eliminations		Total	
	Sugar		Distillery		Total Sugar		Power transmission		Water		Total Engineering		Other Operations		Year ended 31-Mar-20		Year ended 31-Mar-21	
	Year ended 31-Mar-20	Year ended 31-Mar-21	Year ended 31-Mar-20	Year ended 31-Mar-21	Year ended 31-Mar-20	Year ended 31-Mar-21	Year ended 31-Mar-20	Year ended 31-Mar-21	Year ended 31-Mar-20	Year ended 31-Mar-21	Year ended 31-Mar-20	Year ended 31-Mar-21	Year ended 31-Mar-20	Year ended 31-Mar-21	Year ended 31-Mar-20	Year ended 31-Mar-21	Year ended 31-Mar-20	Year ended 31-Mar-21
Amount considered in segment results																		
Depreciation and amortisation	4747.89	4615.13	1555.96	1317.93	6303.85	5933.06	800.07	811.91	188.68	191.13	988.75	1003.04	19.71	19.09	-	-	7312.31	6955.19
Unallocated depreciation and amortisation																	596.45	533.93
Total depreciation and amortisation	4747.89	4615.13	1555.96	1317.93	6303.85	5933.06	800.07	811.91	188.68	191.13	988.75	1003.04	19.71	19.09	-	-	7908.76	7489.12
Non cash items (other than depreciation and amortisation)	(22.00)	(42.16)	(1.11)	113.89	(23.11)	71.73	(81.81)	191.23	401.25	550.14	319.44	741.37	(0.18)	(0.12)	-	-	296.15	812.98
Unallocated non cash items (other than depreciation and amortisation)																	2150.51	39.14
Total non cash items (other than depreciation and amortisation)	(22.00)	(42.16)	(1.11)	113.89	(23.11)	71.73	(81.81)	191.23	401.25	550.14	319.44	741.37	(0.18)	(0.12)	-	-	2446.66	852.12
Amounts not considered in segment results																		
Interest expense	4016.79	6810.07	816.29	622.43	4833.08	7432.50	11.70	31.33	561.31	352.10	573.01	383.43	0.66	0.98	-	-	5406.75	7816.91
Unallocated interest expense																	(263.05)	114.79
Total interest expense	4016.79	6810.07	816.29	622.43	4833.08	7432.50	11.70	31.33	561.31	352.10	573.01	383.43	0.66	0.98	-	-	5143.70	7931.70
Interest income	38.33	54.70	8.47	4.35	46.80	59.05	16.42	12.14	218.83	14.11	235.25	26.25	-	-	-	-	282.05	85.32
Unallocated interest income																	675.50	167.98
Total interest income	38.33	54.70	8.47	4.35	46.80	59.05	16.42	12.14	218.83	14.11	235.25	26.25	-	-	-	-	957.55	253.30
Exceptional items	-	-	-	-	-	-	-	-	-	-	-	-	-	-	-	-	-	-
Unallocated exceptional items																	(2,183.14)	282.04
Total exceptional items	-	-	-	-	-	-	-	-	-	-	-	-	-	-	-	-	(2,183.14)	282.04
Capital expenditure	4027.22	4182.26	2049.44	4914.10	6076.66	9096.36	210.47	307.03	101.69	195.46	312.16	502.49	0.70	33.29	-	-	6389.52	9632.15
Unallocated capital expenditure																	199.62	2289.81
Total Capital expenditure	4027.22	4182.26	2049.44	4914.10	6076.66	9096.36	210.47	307.03	101.69	195.46	312.16	502.49	0.70	33.29	-	-	6589.14	11921.96

(iv) Other segment information

Notes to the Standalone Financial Statements

for the year ended March 31, 2021

(All amounts in ₹ lakhs, unless otherwise stated)

(v) Break-up of revenue by geographical area

	Year ended 31-Mar-21	Year ended 31-Mar-20
India (country of domicile)	466278.90	438908.01
Foreign countries	3041.59	3449.17
	469320.49	442357.18

(vi) Non-current assets by geographical area

All non current assets of the Company are located in India.

(vii) Break-up of revenue from major products and services

	Timing of revenue recognition	Year ended 31-Mar-21	Year ended 31-Mar-20
Sale of products			
Finished goods			
- Sugar	At a point in time	346014.17	323525.14
- Molasses	At a point in time	420.88	505.73
- Bagasse	At a point in time	2684.14	3324.20
- Power	At a point in time	6835.05	5415.62
- Alcohol	At a point in time	54102.27	38977.88
- Mechanical equipment - Water/Waste-water	At a point in time	2687.49	1540.60
- Gears/Gear Boxes (including spares)	At a point in time	12634.12	15027.23
- Others	At a point in time	509.25	387.98
		425887.37	388704.38
Stock in trade			
- Petroleum goods (Diesel/Petrol/Lubricants)	At a point in time	2104.33	1841.41
- Other consumer goods	At a point in time	28.26	18.10
		2132.59	1859.51
		428019.96	390563.89
Sale of services			
Erection and commissioning	Over time	-	4.66
Servicing	Over time	232.18	194.66
Operation and maintenance	Over time	2578.00	2978.25
		2810.18	3177.57
Construction contract revenue			
Water, Waste-water and Sewage treatment	Over time	19771.91	24625.52
Power generation and evacuation system	Over time	62.00	81.49
		19833.91	24707.01
Other operating revenue			
Subsidy from Central Government	At a point in time	18579.03	23472.11
Income from sale of renewable energy certificates	At a point in time	16.06	254.00
Income from scrap	At a point in time	61.35	182.60
		18656.44	23908.71

(viii) Information about major customers

There is no single customer who has contributed 10% or more to the Company's revenue in the years ended 31 March 2021 and 31 March 2020.

Notes to the Standalone Financial Statements

for the year ended March 31, 2021

(All amounts in ₹ lakhs, unless otherwise stated)

NOTE 38: EMPLOYEE BENEFIT PLANS

(i) Defined contribution plans

- (a) The Company contributes to certain defined contribution retirement benefit plans under which the Company pays fixed contributions to separate entities (funds) or financial institutions or state managed benefit schemes. The Company has no further payment obligations once the contributions have been paid. Following are the schemes covered under defined contributions plans of the Company:

Provident Fund Plan & Employee Pension Scheme: The Company makes monthly contributions at prescribed rates towards Employee Provident Fund/ Employee Pension Scheme administered and managed by the Government of India.

Employee State Insurance: The Company makes prescribed monthly contributions towards Employees State Insurance Scheme.

Superannuation Scheme: The Company contributes towards a fund established to provide superannuation benefit to certain employees in terms of Group Superannuation Policies entered into by such fund with the Life Insurance Corporation of India.

National Pension Scheme: The Company makes contributions to the National Pension Scheme fund in respect of certain employees of the Company.

- (b) The expense recognised during the period towards defined contribution plans are as follows:

	Year ended 31-Mar-21	Year ended 31-Mar-20
Employers' contribution to Employees' Provident Fund *1	1289.39	1227.20
Administration and other expenses relating to above *2	40.32	31.41
Employers' contribution to Employees' State Insurance Scheme	7.54	8.80
Employers' contribution to Superannuation Scheme	124.96	127.50
Employers' contribution to National Pension Scheme	50.77	43.56

*1 Contribution for the financial year ended 31 March 2020 includes contribution of ₹ 179.27 lakhs made till October 2019 to a Provident Fund Trust set up by the company for managing the obligations of a specific establishment which had been granted exemption from contributing directly to the Regional Provident Fund Commissioner. The Company requested surrender of the exemption during the financial year ended 31 March 2020 and accordingly, the contributions w.e.f. 1 November 2019 (i.e., contributions in respect of salary payable for the month of October 2019 onwards) has been deposited directly with the provident fund authority and past accumulations of all the members also stand transferred to such authority. The employer's contribution for the financial year ended 31 March 2020, as depicted in the table above, also includes an amount of ₹ 189.50 lakhs towards funding by the Company of the deficit of the Trust in transferring such past accumulations.

*2 Administrative and other expenses payable to the Provident Fund authorities in respect of the financial year ended 31 March 2020 includes ₹ 4.19 lakhs pertaining to the Provident Fund Trust set up by the company as mentioned in * 1 above.

Notes to the Standalone Financial Statements

for the year ended March 31, 2021

(All amounts in ₹ lakhs, unless otherwise stated)

(ii) Defined benefit plan (Gratuity)

(a) The Company operates a defined benefit retirement plan under which the Company pays certain defined benefit by way of gratuity to its employees. The Gratuity Plan provides a lump sum payment to vested employees at retirement/ termination of employment or upon death of an employee, based on the respective employees' salary and years of employment with the Company.

(b) Risk exposure

The plan typically exposes the Company to number of actuarial risks, the most significant of which are detailed below:

Investment risk: The plan liabilities are calculated using a discount rate set with references to government bond yields as at end of reporting period; if plan assets under perform compared to the government bonds discount rate, this will create or increase a deficit. The investments in plan assets are made in accordance with pattern of investment prescribed by central government and ensures that the funds are invested in a balanced mix of investments comprising central government securities, state government securities, other debt instruments as well as equity instruments. Most of the plan investments is in fixed income securities with high grades and in government securities. The Company has a risk management strategy which defines exposure limits and acceptable credit risk rating.

Interest risk: A decrease in government bond yields will increase plan liabilities, although this is expected to be partially offset by an increase in the value of the plan's debt instruments.

Life expectancy: The present value of the defined benefit plan liability is calculated by reference to the best estimate of the mortality of plan participants during their employment. A change in the life expectancy of the plan participants will impact the plan's liability.

Salary risk: The present value of the defined benefit plan liability is calculated by reference to the future salaries of plan participants. As such, an increase in the salary of the plan participants will increase the plan's liability.

Attrition rate: The present value of the defined benefit plan liability is impacted by the rate of employee turnover, disability and early retirement of plan participants. A change in the attrition rate of the plan participants will impact the plan's liability.

(c) The significant actuarial assumptions used for the purposes of the actuarial valuations were as follows:

	Valuation as at	
	31-Mar-21	31-Mar-20
Discounting rate	6.50%	6.60%
Future salary growth rate	5.50% for next year and 8% thereafter	5.50% for next 2 years and 8% thereafter
Mortality table*	IALM 2012-14 Ultimate	IALM 2012-14 Ultimate
Attrition rate	7.00% for Permanent employees 4.00% for Seasonal employees	7.00% for Permanent employees 3.00% for Seasonal employees
Method used	Projected unit credit method	Projected unit credit method

*Assumptions regarding future mortality are set based on actuarial advice in accordance with published statistics (i.e. IALM 2012-14 Ultimate). These assumptions translate into an average life expectancy in years at retirement age.

Notes to the Standalone Financial Statements

for the year ended March 31, 2021

(All amounts in ₹ lakhs, unless otherwise stated)

- (d) Amounts recognised in statement of profit and loss in respect of the defined benefit plan (gratuity) are as follows:

	Year ended 31-Mar-21	Year ended 31-Mar-20
Current service cost	438.48	408.39
Net interest expense	246.77	255.66
Components of defined benefit costs recognised in profit or loss	685.25	664.05
Remeasurement on the net defined benefit liability		
- Return on plan assets (excluding amount included in net interest expense)	(49.22)	66.50
- Actuarial gains and loss arising from changes in demographic assumptions	(7.54)	0.75
- Actuarial gains and loss arising from changes in financial assumptions	36.64	88.07
- Actuarial gains and loss arising from experience adjustments	64.48	(7.46)
Components of defined benefit costs recognised in other comprehensive income	44.36	147.86
Total	729.61	811.91

- (e) Amounts included in the balance sheet arising from the entity's obligation in respect of the defined benefit plan (gratuity) is as follows:

	Year ended 31-Mar-21	Year ended 31-Mar-20
Present value of defined benefit obligation as at the end of the year	6310.39	5727.01
Fair value of plan assets	1753.63	1598.95
Funded status	(4556.76)	(4128.06)
Net asset/(liability) arising from defined benefit obligation recognised in the balance sheet	(4556.76)	(4128.06)

- (f) Movement in the present value of the defined benefit obligation (gratuity) is as follows:

	Year ended 31-Mar-21	Year ended 31-Mar-20
Present value of defined benefit obligation at the beginning of the year	5727.01	5294.33
Expenses recognised in profit or loss		
- Current service cost	438.48	408.39
- Interest expense (income)	352.23	372.81
Remeasurement (gains)/losses recognised in other comprehensive income		
- Actuarial (gain)/loss arising from:		
i. Demographic assumptions	(7.54)	0.75
ii. Financial assumptions	36.64	88.07
iii. Experience adjustments	64.48	(7.46)
Benefit payments	(300.91)	(429.88)
Present value of defined benefit obligation at the end of the year	6310.39	5727.01

Notes to the Standalone Financial Statements

for the year ended March 31, 2021

(All amounts in ₹ lakhs, unless otherwise stated)

(g) Movement in the fair value of the plan assets (gratuity) is as follows:

	Year ended 31-Mar-21	Year ended 31-Mar-20
Fair value of plan assets at the beginning of the year	1598.95	1548.30
Recognised in profit or loss		
- Expected return on plan assets	105.46	117.15
Remeasurement gains / (losses) recognised in other comprehensive income		
- Actual return on plan assets in excess of the expected return	49.22	(66.50)
Contributions by employer	300.91	429.88
Benefit payments	(300.91)	(429.88)
Fair value of plan assets at the end of the year	1753.63	1598.95

The fair value of the plan assets (gratuity) at the end of the reporting period for each category, are as follows:

	As at 31-Mar-21			As at 31-Mar-20		
	Quoted	Unquoted	Total	Quoted	Unquoted	Total
Cash and cash equivalents	-	42.10	42.10	-	17.58	17.58
Debt instruments						
- Government securities	-	266.94	266.94	-	265.60	265.60
- State development loans	-	702.47	702.47	-	563.19	563.19
- Private sector bonds	-	48.00	48.00	-	45.34	45.34
- Public sector bonds	-	309.71	309.71	-	170.85	170.85
- Fixed deposits with banks	-	47.50	47.50	-	142.50	142.50
- Special deposit scheme balance with RBI	-	102.13	102.13	-	102.13	102.13
- Debt mutual funds	-	78.72	78.72	-	74.96	74.96
Equity instruments						
- Index mutual funds	-	90.73	90.73	-	39.76	39.76
- Arbitrage mutual funds	-	14.91	14.91	-	14.34	14.34
Accrued interest and other recoverables	-	50.42	50.42	-	162.70	162.70
Total plan assets	-	1753.63	1753.63	-	1598.95	1598.95

The investible funds of the Gratuity Plan are invested in accordance with the investment pattern and norms prescribed by the Ministry of Finance, Government of India. The investment pattern mandates that the investible funds are invested across the permitted investments in the prescribed pattern, whereby the investment risk is spread across various categories of investment comprising sovereign government securities, state development loans monitored by the Reserve Bank of India, investment grade rated debt securities issued by private and public sector companies, fixed-deposit with banks fulfilling the prescribed norms, units of debt and equity mutual funds. The investments made are generally on held-to-maturity basis. It is the endeavour of the Company to mitigate risk by investing only in high-quality debt securities and in mutual funds after undertaking due diligence. There has been no change in the process used by the Company to manage its risks from prior periods.

Notes to the Standalone Financial Statements

for the year ended March 31, 2021

(All amounts in ₹ lakhs, unless otherwise stated)

(h) Sensitivity analysis

The sensitivity of the defined benefit obligation (gratuity) to changes in the weighted principal assumptions is:

	Change in assumption by	Increase/decrease	Impact on defined benefit obligation (gratuity)			
			Increase in assumption		Decrease in assumption	
			31-Mar-21	31-Mar-20	31-Mar-21	31-Mar-20
Discounting rate	0.50%	in ₹ lakhs	(176.27)	(167.32)	186.74	177.44
		in %	-2.79%	-2.92%	2.96%	3.10%
Future salary growth rate	0.50%	in ₹ lakhs	183.85	175.35	(175.29)	(167.01)
		in %	2.91%	3.06%	-2.78%	-2.92%
Attrition rate	0.50%	in ₹ lakhs	(15.16)	(13.04)	15.84	13.66
		in %	-0.24%	-0.23%	0.25%	0.24%
Mortality rate	10.00%	in ₹ lakhs	(1.06)	(0.90)	1.06	0.90
		in %	-0.02%	-0.02%	0.02%	0.02%

The above sensitivity analysis are based on a change in an assumption while holding all other assumptions constant. In practice, it is unlikely to occur, and changes in some of the assumptions may be correlated. The methods and types of assumptions used in preparing the sensitivity analysis did not change compared to prior period.

(i) Defined benefit liability (gratuity) and employer contributions

The Company remains committed to fund all gratuity payments falling due and shall strive to gradually reduce the deficit in funding of its obligation in the coming years.

The Company expects to contribute ₹ 1016.94 lakhs to the defined benefit plan relating to gratuity during the next financial year.

The weighted average duration of the defined gratuity obligation (on discounted cash flow basis) as at 31 March 2021 is 6 years (31 March 2020: 6 years).

The expected maturity analysis of undiscounted defined benefit obligation (gratuity) as at 31 March 2021 is as follows:

	Less than a year	Between 1-2 years	Between 3-5 years	Over 5 years	Total
Defined benefit obligation (Gratuity)	1473.53	763.33	1864.53	5839.76	9941.15

(iii) The President has given his assent to The Code on Social Security, 2020 ('Code') in respect of employee benefits (during employment and post-employment) in September 2020. The Code may impact the contributions made by the Company towards Provident Fund and Gratuity. However, the date on which the Code will come into effect has not yet been notified. The Company would assess and give effect to the implications, if any, arising from the implementation of the Code, in the period in which, the Code becomes effective and the related rules are notified.

Notes to the Standalone Financial Statements

for the year ended March 31, 2021

(All amounts in ₹ lakhs, unless otherwise stated)

NOTE 39: RELATED PARTY TRANSACTIONS

(i) Subsidiaries (wholly owned)

- where control exists

Triveni Energy Systems Limited
 Triveni Engineering Limited
 Triveni Entertainment Limited
 Svastida Projects Limited
 Triveni Industries Limited
 Triveni Sugar Limited
 Mathura Wastewater Management Private Limited
 United Shippers & Dredgers Limited (w.e.f. 25 March 2021)
 Gaurangi Enterprises Limited (incorporated on 2 July 2020)

- others - incorporated under section 8 of the Companies Act, 2013

Triveni Foundation (incorporated on 28 June 2020)

(ii) Related parties with whom transactions have taken place during the year alongwith details of such transactions and outstanding balances as at the end of the year:

Name of related party and nature of transactions	Relationship	Year ended 31-Mar-21	Year ended 31-Mar-20
Sales and rendering services			
Triveni Sugar Limited	Subsidiary	0.71	0.71
Svastida Projects Limited	Subsidiary	0.71	0.71
Triveni Entertainment Limited	Subsidiary	0.71	0.71
Triveni Energy Systems Limited	Subsidiary	0.71	0.71
Triveni Engineering Limited	Subsidiary	0.71	0.71
Triveni Industries Limited	Subsidiary	0.71	0.71
Gaurangi Enterprises Limited	Subsidiary	0.53	-
Mathura Wastewater Management Private Limited	Subsidiary	8752.10	11141.70
Triveni Turbine Limited	Associate	2877.84	3539.25
Purchases and receiving services			
Triveni Turbine Limited	Associate	222.85	293.61
Tirath Ram Shah Charitable Trust	Enterprise over which Key managerial personnel have substantial interest/ significant influence	-	0.91
Interest income			
Mathura Wastewater Management Private Limited	Subsidiary	387.12	26.58
Aqwise Wise Water Technologies Limited (Israel)	Associate	127.48	9.50
Rent & other charges received			
Triveni Turbine Limited	Associate	19.82	21.81
Dividend received from investment in equity shares			

Notes to the Standalone Financial Statements

for the year ended March 31, 2021

(All amounts in ₹ lakhs, unless otherwise stated)

Name of related party and nature of transactions	Relationship	Year ended 31-Mar-21	Year ended 31-Mar-20
Triveni Turbine Limited	Associate	-	353.14
Rent paid			
Dhruv M. Sawhney (Chairman & Managing Director) *	Key managerial personnel	59.37	53.97
Rati Sawhney	Relative of key managerial personnel	38.77	36.82
Kameni Upaskar Limited	Enterprise over which key managerial personnel have substantial interest/ significant influence	93.55	84.88
Corporate Social Responsibility expenses			
Tirath Ram Shah Charitable Trust	Enterprise over which key managerial personnel have substantial interest/ significant influence	83.21	-
Triveni Foundation	Subsidiary incorporated u/s 8 of the Companies Act, 2013	65.00	-
Remuneration			
Tarun Sawhney (Vice Chairman & Managing Director)	Key managerial personnel	650.39	556.27
Suresh Taneja (Group Chief Financial Officer)	Key managerial personnel	233.38	226.16
Geeta Bhalla (Group Vice President & Company Secretary)	Key managerial personnel	95.60	87.17
Directors fee paid			
Nikhil Sawhney (Promoter Non-Executive Director)	Key managerial personnel	9.60	11.40
Lt. Gen (Retd.) Kanwal Kishan Hazari (Independent Non-Executive Director)	Key managerial personnel	-	8.20
Shekhar Dutta (Independent Non-Executive Director)	Key managerial personnel	14.75	11.25
Homai A. Daruwalla (Independent Non-Executive Director)	Key managerial personnel	15.00	10.50
Dr. Santosh Pande (Independent Non-Executive Director)	Key managerial personnel	10.60	10.80
Sudipto Sarkar (Independent Non-Executive Director)	Key managerial personnel	12.00	9.50
J. K. Dadoo (Independent Non-Executive Director)	Key managerial personnel	8.00	7.00
Directors commission			

Notes to the Standalone Financial Statements

for the year ended March 31, 2021

(All amounts in ₹ lakhs, unless otherwise stated)

Name of related party and nature of transactions	Relationship	Year ended 31-Mar-21	Year ended 31-Mar-20
Nikhil Sawhney (Promoter Non-Executive Director)	Key managerial personnel	45.00	30.00
Shekhar Dutta (Independent Non-Executive Director)	Key managerial personnel	10.00	8.50
Homai A. Daruwalla (Independent Non-Executive Director)	Key managerial personnel	11.00	8.50
Dr. Santosh Pande (Independent Non-Executive Director)	Key managerial personnel	10.00	8.50
Sudipto Sarkar (Independent Non-Executive Director)	Key managerial personnel	10.00	8.50
J. K. Dadoo (Independent Non-Executive Director)	Key managerial personnel	10.00	8.50
Contribution to post employment benefit plans			
Triveni Engineering Works Limited Gratuity Fund	Post employment benefit plan	300.91	428.04
Triveni Engineering and Industries Limited Officers Pension Scheme	Post employment benefit plan	124.96	127.50
Upper India Sugar Mills Employees' Provident Fund	Post employment benefit plan	-	529.59
Contribution towards deficiency in provident fund trust			
Upper India Sugar Mills Employees' Provident Fund	Post employment benefit plan	-	189.50
Expenses incurred by the Company on behalf of party (net of expenses incurred by party on behalf of the Company) on reimbursable basis			
Mathura Wastewater Management Private Limited	Subsidiary	107.39	82.59
Triveni Sugar Limited	Subsidiary	1.73	3.05
Triveni Industries Limited	Subsidiary	1.76	3.21
Gaurangi Enterprises Limited	Subsidiary	12.25	-
Svastida projects Limited	Subsidiary	1.78	-
Triveni Turbine Limited	Associate	1.49	23.91
Kameni Upaskar Limited	Enterprise over which key managerial personnel have substantial interest/ significant influence	(3.76)	(2.82)
Triveni Engineering Works Limited Gratuity Fund	Post employment benefit plan	(0.02)	(0.02)
Triveni Engineering and Industries Limited Officers Pension Scheme	Post employment benefit plan	(0.00)	(0.00)
Triveni Engineering Works Limited Employees' Provident Fund	Post employment benefit plan	-	(0.00)

Notes to the Standalone Financial Statements

for the year ended March 31, 2021

(All amounts in ₹ lakhs, unless otherwise stated)

Name of related party and nature of transactions	Relationship	Year ended 31-Mar-21	Year ended 31-Mar-20
Upper India Sugar Mills Employees' Provident Fund	Post employment benefit plan	-	(0.19)
Dividend paid on equity shares			
Dhruv M. Sawhney (Chairman & Managing Director) *	Key managerial personnel	-	425.16
Tarun Sawhney (Vice Chairman & Managing Director)	Key managerial personnel	-	155.72
Nikhil Sawhney (Promoter Non-Executive Director)	Key managerial personnel	-	161.89
Suresh Taneja (Group Chief Financial Officer)	Key managerial personnel	-	0.15
Shekhar Dutta (Independent Non-Executive Director)	Key managerial personnel	-	0.11
Manmohan Sawhney HUF	Relative of key managerial personnel	-	47.82
Rati Sawhney	Relative of key managerial personnel	-	197.30
Tarana Sawhney	Relative of key managerial personnel	-	0.26
STFL Trading and Finance Private Limited *	Enterprise over which key managerial personnel have substantial interest/significant influence	-	875.94
Buy-back of equity shares			
Dhruv M. Sawhney (Chairman & Managing Director) *	Key managerial personnel	962.94	1479.98
Tarun Sawhney (Vice Chairman & Managing Director)	Key managerial personnel	352.68	539.25
Nikhil Sawhney (Promoter Non-Executive Director)	Key managerial personnel	366.66	560.62
Suresh Taneja (Group Chief Financial Officer)	Key managerial personnel	0.35	0.54
Manmohan Sawhney HUF	Relative of key managerial personnel	108.31	165.62
Rati Sawhney	Relative of key managerial personnel	446.85	683.24
Tarana Sawhney	Relative of key managerial personnel	0.60	0.92

Notes to the Standalone Financial Statements

for the year ended March 31, 2021

(All amounts in ₹ lakhs, unless otherwise stated)

Name of related party and nature of transactions	Relationship	Year ended 31-Mar-21	Year ended 31-Mar-20
STFL Trading and Finance Private Limited *	Enterprise over which key managerial personnel have substantial interest/ significant influence	1986.55	3064.93
Sale of property, plant & equipment			
Tirath Ram Shah Charitable Trust	Enterprise over which key managerial personnel have substantial interest/ significant influence	1.05	1.29
Sale of investment property			
Triveni Sugar Limited	Subsidiary	-	173.15
Svastida Projects Limited	Subsidiary	-	213.07
Triveni Industries Limited	Subsidiary	-	175.33
Gaurangi Enterprises Limited	Subsidiary	166.32	-
Investment made in equity shares			
Triveni Industries Limited	Subsidiary	-	200.00
Triveni Sugar Limited	Subsidiary	-	200.00
Svastida Projects Limited	Subsidiary	-	240.00
Mathura Wastewater Management Private Limited	Subsidiary	-	1350.00
Gaurangi Enterprises Limited	Subsidiary	200.00	-
Triveni Foundation	Subsidiary	1.00	-
	incorporated u/s 8 of the Companies Act, 2013		
Acquisition of equity shares of United Shippers & Dredgers Limited			
Subhadra Trade and Finance Limited	Enterprise over which key managerial personnel have substantial interest/ significant influence	23.00	-
Purchase of investment in bonds			
Upper India Sugar Mills Employees' Provident Fund	Post employment benefit plan	165.27	-
Advance paid against purchase of bonds			
Upper India Sugar Mills Employees' Provident Fund	Post employment benefit plan	-	160.00
Short term loans given and repaid			
Mathura Wastewater Management Private Limited	Subsidiary	1530.00	-
Loans given			
Mathura Wastewater Management Private Limited	Subsidiary	490.00	1430.00
Aqwise Wise Water Technologies Limited (Israel)	Associate	1875.05	-

Related party transactions stated above are inclusive of applicable taxes

Notes to the Standalone Financial Statements

for the year ended March 31, 2021

(All amounts in ₹ lakhs, unless otherwise stated)

Outstanding balances

Name of related party and nature of balances	Relationship	As at 31-Mar-21	As at 31-Mar-20
Receivable			
Mathura Wastewater Management Private Limited	Subsidiary	7088.29	6315.46
United Shippers & Dredgers Limited	Subsidiary	44.53	N.A.
Triveni Turbine Limited	Associate	380.12	271.68
Aqwise Wise Water Technologies Limited (Israel)	Associate	1831.47	305.50
Upper India Sugar Mills Employees' Provident Fund	Post employment benefit plan	-	160.00
Tirath Ram Shah Charitable Trust	Enterprise over which key managerial personnel have substantial interest/ significant influence	1.05	-
Provision for doubtful debts/advances			
United Shippers & Dredgers Limited	Subsidiary	44.53	N.A.
Payable			
Mathura Wastewater Management Private Limited	Subsidiary	148.07	930.32
Triveni Turbine Limited	Associate	501.76	1374.78
Dhruv M. Sawhney (Chairman & Managing Director) *	Key managerial personnel	3.27	4.11
Tarun Sawhney (Vice Chairman & Managing Director)	Key managerial personnel	253.20	153.65
Suresh Taneja (Group Chief Financial Officer)	Key managerial personnel	0.20	0.13
Nikhil Sawhney (Promoter Non-Executive Director)	Key managerial personnel	45.46	30.00
Shekhar Dutta (Independent Non-Executive Director)	Key managerial personnel	10.00	8.50
Homai A. Daruwalla (Independent Non-Executive Director)	Key managerial personnel	11.46	8.50
Dr. Santosh Pande (Independent Non-Executive Director)	Key managerial personnel	10.46	8.50
Sudipto Sarkar (Independent Non-Executive Director)	Key managerial personnel	10.00	8.50
J. K. Dadoo (Independent Non-Executive Director)	Key managerial personnel	10.00	8.50
Tirath Ram Shah Charitable Trust	Enterprise over which key managerial personnel have substantial interest/ significant influence	-	1.02

Notes to the Standalone Financial Statements

for the year ended March 31, 2021

(All amounts in ₹ lakhs, unless otherwise stated)

Name of related party and nature of balances	Relationship	As at 31-Mar-21	As at 31-Mar-20
Triveni Engineering and Industries Limited Officers Pension Scheme	Post employment benefit plan	124.96	127.50
Upper India Sugar Mills Employees' Provident Fund	Post employment benefit plan	-	189.69
Guarantees / surety / commitment outstanding			
Mathura Wastewater Management Private Limited (see (v) below)	Subsidiary	10000.00	9915.00

* Person or entity belonging to the promoter/promoter group holding 10% or more shareholding in the Company

(iii) Remuneration of key managerial personnel:

	Year ended 31-Mar-21	Year ended 31-Mar-20
Short-term employee benefits	914.84	805.88
Post-employment benefits	64.53	63.72
Total	979.37	869.60

The remuneration of key managerial personnel is determined by the remuneration committee having regard to the performance of individuals, market trends and applicable provisions of Companies Act, 2013.

- (iv) Remuneration and outstanding balances of key managerial personnel does not include long term employee benefits by way of gratuity and compensated absences, which are currently not payable and are provided on the basis of actuarial valuation by the Company.
- (v) The Company has provided a corporate guarantee amounting to ₹ 10000 lakhs (31 March 2020: ₹ 9915 lakhs) in connection with a loan agreed to be granted by the lender to a wholly owned subsidiary of the Company, Mathura Wastewater Management Private Limited (MWMPL). MWMPL has availed loan of ₹ 5100 lakhs during the year (till 31 March 2020: ₹ Nil) under such lending arrangement.

(vi) Terms & conditions:

- Transactions relating to dividends, buyback of shares were on same terms and conditions that applied to other shareholders.
- Loans to subsidiary and associate are given at normal commercial terms & conditions at prevailing market rate of interest.
- Sales to and purchases from related parties, including rendering/availment of service, are made on terms equivalent to those that prevail in arm's length transactions. All other transactions were made on normal commercial terms and conditions and at market rates.
- The outstanding balances at the year-end are unsecured and settlement occurs in cash.

Notes to the Standalone Financial Statements

for the year ended March 31, 2021

(All amounts in ₹ lakhs, unless otherwise stated)

NOTE 40: CAPITAL MANAGEMENT

For the purpose of capital management, capital includes net debt and total equity of the Company. The primary objective of the capital management is to maximize shareholder value along with an objective to keep the leverage in check in view of cyclical capital intensive sugar business of the Company.

One of the major businesses of the Company is the sugar business, a seasonal industry, where the entire production occurs in about five to six months which is sold throughout the year. Thus, it necessitates keeping high levels of sugar inventory requiring high working capital funding. Sugar business being also a cyclical business, it is prudent to avoid high leverage and the resultant high finance cost. It is the endeavour of the Company to prune down debts to acceptable levels based on its financial position.

The Company may resort to further issue of capital when the funds are required to make the Company stronger financially or to invest in projects meeting the ROI expectations of the Company.

The Company monitors capital structure through gearing ratio represented by debt-equity ratio (debt/total equity). In addition to the gearing ratio, the Company also looks at long term debt to operating profit ratio (long term debt/EBITDA) which gives an indication of adequacy of earnings to service the debts. The Company carefully negotiates the terms and conditions of the loans and ensures adherence to all the financial covenants. With a view to arrive at the desired capital structure based on the financial condition of the Company, the Company normally incorporates a clause in loan agreements for prepayment of loans without any premium. The gearing ratios and long term debt/EBITDA ratio for the Company as at the end of reporting period were as follows:

	As at 31-Mar-21	As at 31-Mar-20
Non-current borrowings (note 16)	26068.26	44359.64
Current borrowings (note 20)	56157.43	94343.87
Current maturities of long-term borrowings (note 17)	10460.22	14306.72
Total debt	92685.91	153010.23
Add: Deferred revenue arising from government grant related to borrowings (refer note 19)	1680.06	2805.32
Less: Cash and cash equivalents [note 12(a)]	(992.41)	(3058.30)
Net debt	93373.56	152757.25
Total equity (note 14 & note 15)	146323.72	127065.34
EBITDA (before exceptional items)	58422.73	57283.31
Net debt to equity ratio	0.64	1.20
Long term debt equity ratio	0.26	0.48
Long term debt/EBITDA ratio	0.65	1.07

No changes were made in the objectives, policies or process for managing capital during the years ended 31 March 2021 and 31 March 2020.

The Company is not subject to any externally imposed capital requirements.

Notes to the Standalone Financial Statements

for the year ended March 31, 2021

(All amounts in ₹ lakhs, unless otherwise stated)

NOTE 41: FINANCIAL RISK MANAGEMENT

The Company's principal financial liabilities comprise loans and borrowings, trade payables and other payables. The main purpose of the financial liabilities is to finance the Company's operations. The Company's principal financial assets include loans, trade and other receivables and cash and bank balances that derive directly from its operations. The Company also holds investments measured at fair value through profit or loss and enters into derivative transactions, which are not extensive.

The Company's activities expose it mainly to market risk, liquidity risk and credit risk. The monitoring and management of such risks is undertaken by the senior management of the Company and there are appropriate policies and procedures in place through which such financial risks are identified, measured and managed in accordance with the Company's policies and risk objectives. The Company has specialised teams to undertake derivative activities for risk management purposes and such team has appropriate skills, experience and expertise. It is the Company policy not to carry out any trading in derivative for speculative purposes. The Audit Committee and the Board are regularly apprised of these risks every quarter and each such risk and mitigation measures are extensively discussed.

(i) Credit risk

Credit risk is associated with the possibility of a counterparty defaulting on its contractual obligations to pay, resulting in financial loss to the Company. The Company is exposed to credit risks from its operating activities, primarily trade receivables. The credit risks in respect of deposits with the banks, foreign exchange transactions and other financial instruments are nominal. As required, the Company also advances loans to its associates/subsidiary companies and there is some credit risk associated with it. As far as practicable, the Company endeavours to take reasonable security to mitigate the credit risk.

(a) Credit risk management

The customer credit risk is managed by each business subject to the Company's established policy, procedure and controls relating to customer credit risk management. Various businesses require different processes and policies to be followed based on the business risks, industry practice and customer profiles.

In the case of Sugar business, majority of the sales are made either against advance payments or on very short credit period upto 7-10 days through established sugar agents whereas in Cogeneration, forming part of sugar business, and Distillery, most of the sales are made to Government customers, such as, State Electricity Board (UPPCL) and Oil Marketing Companies (OMCs). There may be delays, generally not exceeding one year, in receiving payments from UPPCL but the risk in respect of realisation of dues is minimal. In Power transmission business, it is the policy of the Company to receive payment prior to delivery of the material except in the case of some well established OEMs, including group companies and public sector undertakings, where the credit up to 90 days is extended. Water business is engaged in Engineering, Procurement and Construction (EPC) business in the municipal and industrial sectors where it is customary to have prescribed retentions which are payable upon completion of the project and after satisfactory performance of the plant.

In order to contain the business risk, creditworthiness of the customer is ensured through scrutiny of its financials, status of financial closure of the project, if required, market reports and reference checks. The Company remains vigilant and regularly assesses the financial position of customers during execution of contracts with a view to restrict risks of delays and default. In view of its diversified business profile and considering the size of the Company, credit risks from receivables are well contained on an overall basis.

The impairment analysis is performed on each reporting period on individual basis for major customers. In addition, a large number of receivables are grouped and assessed for impairment collectively. The calculation of impairment loss is based on historical data of losses, current conditions and forecasts and future economic conditions. The Company's maximum exposure to credit risk at the reporting date is the carrying amount of each financial asset as detailed in note 6, 7, 8, 9 and 12.

Notes to the Standalone Financial Statements

for the year ended March 31, 2021

(All amounts in ₹ lakhs, unless otherwise stated)

The business wise receivable position as at the end of the year is provided here below:

	Year ended 31-Mar-21			Year ended 31-Mar-20		
	External sales (A)	Year end receivables (B)	% Receivables (B/A)	External sales (A)	Year end receivables (B)	% Receivables (B/A)
Sugar business	351399.03	5726.64	2%	327598.42	9315.82	3%
Distillery business	54350.99	3206.57	6%	39095.34	3261.83	8%
Power transmission business	12909.37	4248.02	33%	15272.61	2661.87	17%
Water business	25055.68	8682.40	35%	29280.91	13930.55	48%
Others	7026.39	199.27	3%	7637.79	361.45	5%
Total	450741.46	22062.90	5%	418885.07	29531.52	7%

In the case of Water business, the % receivables to external sales is high whereas the overall ratio for the Company is much lower. In the case of EPC projects undertaken by Water business, the receivables are high as per the norms of the industry and terms of the tender. Majority of projects are executed for the municipalities and before bidding for any contract, the Water business carries out due-diligence to ensure that the customer has made satisfactory funding arrangements. In the case of Power transmission business, the % receivable to external sales is high due to higher year end sales and lower turnover of the business during the year.

Overall, the credit risk from receivable is low in view of diverse businesses and government customers.

(b) Provision for expected credit losses

Basis as explained above, life time expected credit loss ("ECL") is determined on trade receivables except in cases where advance payment terms are prescribed or payment is due from Central / State Government or Government Authorities / entities where there is no track record of short receipts. ECL arising from delays in receiving payments from the Government customers pursuant to sale of goods or under construction contracts are not considered if such delays are commonly prevalent in the industry and / or the delays are not exceeding one year. All other short receipts, other than arising from expense claims, are duly considered in determining ECL. In view of the business model of the Company's engineered-to-order products and the profile of trade receivables, the determination of provision based on age analysis may not be realistic and hence, the provision of expected credit loss is determined for the total trade receivables outstanding as on the reporting date. This provision for ECL is made in addition to the specific credit losses, if any, provided on specific financial assets.

Provision matrix (% , amounts) of ECL for trade receivables (other than specific credit losses separately recognised) is as under:

Business	% ECL	ECL amount as at 31-Mar-21	ECL amount as at 31-Mar-20
Sugar	Nil	Nil	Nil
Distillery	Nil	Nil	Nil
Power transmission	0.84%	36.59	32.90
Water	1.15%	100.40	114.75

Notes to the Standalone Financial Statements

for the year ended March 31, 2021

(All amounts in ₹ lakhs, unless otherwise stated)

(c) Reconciliation of loss allowance provision

Trade receivables:

	Year ended 31-Mar-21	Year ended 31-Mar-20
Balance at beginning of the year	1801.33	1254.92
Provision for credit loss allowance made during the year	445.45	931.04
Provision reversed/utilised during the year	(135.80)	(384.63)
Balance at the end of the year	2110.98	1801.33

Loans and other financial assets:

	Loans		Other financial assets	
	Year ended 31-Mar-21	Year ended 31-Mar-20	Year ended 31-Mar-21	Year ended 31-Mar-20
Balance at beginning of the year	44.53	44.53	15.05	15.05
Movement in expected credit loss allowance during the year	-	-	-	-
Balance at the end of the year	44.53	44.53	15.05	15.05

(ii) Liquidity risk

The Company uses liquidity forecast tools to manage its liquidity. The Company operates capital intensive sugar business and has obligation to timely make cane price payments within the statutory time period. The Company is able to organise liquidity through own funds and through working capital loans. The Company has good relationship with its lenders and has not defaulted at any point of time in the past, as a result of which it does not experience any difficulty in arranging funds from its lenders. However, when the sugar fundamentals are unfavourable, either due to market forces or due to excessive cane pricing by the Government, the payment of cane price gets delayed. However, it is the endeavour of the Company to make cane payment on a priority basis. It is the objective and focus of the Company to reduce debts to be able to meet the cyclicalities of the sugar business.

Apart from cyclical sugar business, the Company has alternate revenue streams in the form of distillery and engineering business, which, to a large extent, offset the impact of sugar cyclicalities.

Table hereunder provides the current ratios of the Company as at the year end

	As at 31-Mar-21	As at 31-Mar-20
Total current assets	225453.25	268153.86
Total current liabilities	156162.09	209391.84
Current ratio	1.44	1.28

In view of seasonal nature of sugar business, which is a dominant business of the Company, there is a peak build-up of sugar inventories at the year end, resulting in peak working capital requirement. With the liquidation of such inventories over the year, the working capital requirement is gradually reduced. Thus, the current ratio computed at the year end is not a reflection of average and realistic ratio for the year.

Notes to the Standalone Financial Statements

for the year ended March 31, 2021

(All amounts in ₹ lakhs, unless otherwise stated)

(a) Maturities of financial instruments

Maturities of non-derivative financial liabilities:

The following tables detail the remaining contractual maturity for its non-derivative financial liabilities with agreed repayment periods. The amount disclosed in the tables have been drawn up based on the undiscounted cash flows of financial liabilities. The contractual maturity is based on the earliest date on which the Company may be required to pay.

	on demand	< 1 year	1-3 years	3-5 years	> 5 years	Total	Carrying amount
As at 31 March 2021							
Borrowings	56157.43	11328.22	23739.44	3164.31	-	94389.40	92685.91
Trade payables	-	61737.53	675.45	-	-	62412.98	62412.98
Lease liabilities	-	352.85	595.44	373.01	4.23	1325.53	1325.53
Other financial liabilities	-	4727.17	-	-	-	4727.17	4727.17
	56157.43	78145.77	25010.33	3537.32	4.23	162855.08	161151.59
As at 31 March 2020							
Borrowings	94343.87	15446.73	31439.22	14620.62	-	155850.44	153010.23
Trade payables	-	74901.11	738.92	-	-	75640.03	75640.03
Lease liabilities	-	544.87	575.14	618.11	28.38	1766.50	1766.50
Other financial liabilities	-	5225.42	-	-	-	5225.42	5225.42
	94343.87	96118.13	32753.28	15238.73	28.38	238482.39	235642.18

Maturities of derivative financial instruments:

The Company enters into derivative contracts (viz. foreign exchange forward contracts) to manage some of its foreign currency exposures that are settled on a net basis. Derivative asset (net) are of ₹ 35.92 lakhs as at 31 March 2021 (31 March 2020 : Derivative liability (net) ₹ 2.19 lakhs), shall mature within one year from reporting date.

(iii) Market risk

The Company is exposed to following key market risks:

- Interest rate risk on loans and borrowings
- Sugar price risk
- Other market risks

(a) Interest rate risk

Most of the borrowings availed by the Company are subject to interest on floating rate basis linked to the MCLR (Marginal Cost of funds based Lending Rate). In view of the fact that the total borrowings of the Company are quite substantial, the Company is exposed to interest rate risk.

The strategy of the Company to opt for floating interest rates is helpful in maintaining market related realistic rates. Further, most of the loans and borrowings have a prepayment clause through which the loans could be prepaid without any prepayment premium. The said clause helps the Company to arrange debt substitution to bring down the interest costs or to prepay the loans out of the surplus funds held. The interest rate risk is largely mitigated as 98% of the long term debts as at 31 March 2021 (31 March 2020 : 99% of long term debts), comprises loans carrying concessional interest rates/interest subvention.

Notes to the Standalone Financial Statements

for the year ended March 31, 2021

(All amounts in ₹ lakhs, unless otherwise stated)

While declining interest rates would be beneficial to the Company, adverse interest rate fluctuations could increase the finance cost. The total impact, in respect of borrowings on floating interest rate basis, is limited as per sensitivity analysis provided here under:

	Year ended 31-Mar-21	Year ended 31-Mar-20
Total debt as at the end of the year	92685.91	153010.23
Debt at floating rate of interest as at the end of the year	70992.74	124478.82
Average availment of borrowings at floating rate of interest	68582.98	127516.81
Impact of 1% interest rate variation	685.83	1275.17

The above sensitivity has been computed after excluding the impact of change in interest rates of the floating interest rate foreign currency borrowing having balance of USD 1,792,114.69 @ 4.833% p.a. (i.e. 6 months LIBOR plus 1.95%) as at 31 March 2019, fully repaid during the previous year, since same had been hedged through interest rate swap @ fixed interest rate 8.5% p.a.

(b) Sugar price risk

The sugar prices are dependent inter-alia on domestic and global sugar balance - higher supplies lead to softening of sugar prices whereas higher demand than available supplies lead to hardening of sugar prices. The Company sells most of its sugar in the domestic market where there are no effective mechanism available to hedge sugar prices in view of limited breadth in the commodity exchanges. The Company also exports sugar in the years of surplus production based on Government policy and incentives being offered.

Adverse changes in sugar price impact the Company in the following manner:

- The Company values sugar stocks at lower of cost and net realisable value (NRV). In the event, the cost of production of sugar is higher than the NRV, the stocks are written down to NRV leading to recognition of loss on such inventory.
- The Company is a large producer of sugar and even a small variation in the sugar price leads to significant impact on the profitability of the Company.

Sensitivity analysis in respect of sugar price risk is provided here below:

	Year ended 31-Mar-21	Year ended 31-Mar-20
Annual production of sugar (MT)	1007299	971918
Impact of sugar price variation by ₹ 1000/MT	10072.99	9719.18

However, in view of sugar operations being highly efficient, the cost of production is generally lower than the Minimum Sale Prices (MSP) prescribed by the Central Government for sale of sugar and hence, chances of significant losses due to inventory write down are low. Further, in view of floor prices being prescribed by way of MSP, the downside impact on the Company is limited.

Notes to the Standalone Financial Statements

for the year ended March 31, 2021

(All amounts in ₹ lakhs, unless otherwise stated)

(c) Other market risks

The other market risks includes Equity price risk and Foreign currency risk.

Equity price risk in respect of listed and non listed equity securities which are susceptible to market price risk arising from uncertainties about future value of the investment securities. In view of nominal value of investments being held by the Company, other than in the subsidiaries and associates which are measured at cost, the magnitude of risk is only nominal.

The Company is exposed to foreign currency risk on account of foreign currency loans receivables and foreign exchange trades.

Foreign currency risk exposure

The Company's exposure to foreign currency risk at the end of the reporting period are as follows:

		US\$	EURO	GBP	SGD
As at 31 March 2021					
Financial assets					
- Trade receivables	in foreign currency lakhs	3.05	8.08	1.03	-
	in equivalent ₹ lakhs	221.69	682.91	101.93	-
- Loans receivables	in foreign currency lakhs	25.19	-	-	-
	in equivalent ₹ lakhs	1831.47	-	-	-
Derivatives (in respect of underlying financial assets)					
- Foreign exchange forward contracts sell foreign currency	in foreign currency lakhs	-	6.04	-	-
	in equivalent ₹ lakhs	-	510.56	-	-
Net exposure to foreign currency risk (assets)	in foreign currency lakhs	28.24	2.04	1.03	-
	in equivalent ₹ lakhs	2053.16	172.35	101.93	-
Financial liabilities					
- Trade payables	in foreign currency lakhs	0.62	1.56	0.07	0.04
	in equivalent ₹ lakhs	46.01	136.36	7.51	2.02
Derivatives (in respect of underlying financial liabilities)					
- Foreign exchange forward contracts buy foreign currency	in foreign currency lakhs	-	-	-	-
	in equivalent ₹ lakhs	-	-	-	-
Net exposure to foreign currency risk (liabilities)	in foreign currency lakhs	0.62	1.56	0.07	0.04
	in equivalent ₹ lakhs	46.01	136.36	7.51	2.02

Notes to the Standalone Financial Statements

for the year ended March 31, 2021

(All amounts in ₹ lakhs, unless otherwise stated)

		US\$	EURO	GBP	SGD
As at 31 March 2020					
Financial assets					
- Trade receivables	in foreign currency lakhs	3.10	0.73	-	-
	in equivalent ₹ lakhs	231.64	60.07	-	-
- Loans receivables	in foreign currency lakhs	4.09	-	-	-
	in equivalent ₹ lakhs	305.50	-	-	-
Derivatives (in respect of underlying financial assets)					
- Foreign exchange forward contracts sell foreign currency	in foreign currency lakhs	4.06	-	-	-
	in equivalent ₹ lakhs	303.40	-	-	-
Net exposure to foreign currency risk (assets)	in foreign currency lakhs	3.13	0.73	-	-
	in equivalent ₹ lakhs	233.74	60.07	-	-
Financial liabilities					
- Trade payables	in foreign currency lakhs	3.59	0.40	0.65	-
	in equivalent ₹ lakhs	273.30	33.92	61.44	-
- Borrowings (including interest)	in foreign currency lakhs	-	-	-	-
	in equivalent ₹ lakhs	-	-	-	-
Derivatives (in respect of underlying financial liabilities)					
- Foreign exchange forward contracts buy foreign currency	in foreign currency lakhs	2.92	-	-	-
	in equivalent ₹ lakhs	222.20	-	-	-
Net exposure to foreign currency risk (liabilities)	in foreign currency lakhs	0.67	0.40	0.65	-
	in equivalent ₹ lakhs	51.10	33.92	61.44	-

The Company's foreign currency derivatives outstanding (including for firm commitments) at the end of the reporting period are as follows:

		US\$	EURO	GBP	SGD
As at 31 March 2021					
Foreign exchange forward contracts to sell foreign currency	in foreign currency lakhs	4.06	12.71	-	-
	in equivalent ₹ lakhs	295.49	1074.42	-	-
Foreign exchange forward contracts to buy foreign currency	in foreign currency lakhs	-	-	-	-
	in equivalent ₹ lakhs	-	-	-	-
As at 31 March 2020					
Foreign exchange forward contracts to sell foreign currency	in foreign currency lakhs	5.69	-	-	-
	in equivalent ₹ lakhs	425.24	-	-	-
Foreign exchange forward contracts to buy foreign currency	in foreign currency lakhs	2.92	2.58	-	-
	in equivalent ₹ lakhs	222.20	218.47	-	-

All the above contracts are maturing within one year from the reporting date.

Notes to the Standalone Financial Statements

for the year ended March 31, 2021

(All amounts in ₹ lakhs, unless otherwise stated)

Sensitivity

The following table demonstrate the sensitivity of net unhedged foreign currency exposures relating to financial instruments to reasonably possible changes in foreign currency exchange rates, with all other variables held constant.

	Change in FC exchange rate by	Impact on profit or loss and equity (in ₹ lakhs)			
		Increase in FC exchange rates		Decrease in FC exchange rates	
		31-Mar-21	31-Mar-20	31-Mar-21	31-Mar-20
US\$ sensitivity	5%	100.36	9.13	(100.36)	(9.13)
EURO sensitivity	5%	1.80	1.31	(1.80)	(1.31)
GBP sensitivity	5%	4.72	(3.07)	(4.72)	3.07
SGD sensitivity	5%	(0.10)	-	0.10	-

Further, the impact of change in foreign currency rates (assuming forward premium to remain unchanged) on the fair valuation of derivatives (excluding derivatives which have hedged the foreign currency denominated receivables and payables) as at the end of the year, is demonstrated in the table below. However, apart from the impact on the profit or loss due to fair value changes of the derivatives, the derivatives will help the Company in capturing the hedged rates including forward premium and the budgeted profitability will remain unaffected.

	Change in FC exchange rate by	Impact on profit or loss and equity (in ₹ lakhs)			
		Increase in FC exchange rates		Decrease in FC exchange rates	
		31-Mar-21	31-Mar-20	31-Mar-21	31-Mar-20
US\$ sensitivity	5%	(14.77)	(6.09)	14.77	6.09
EURO sensitivity	5%	(28.19)	10.92	28.19	(10.92)
GBP sensitivity	5%	-	-	-	-
SGD sensitivity	5%	-	-	-	-

There is no impact on other components of equity since the Company has not elected to apply hedge accounting.

Notes to the Standalone Financial Statements

for the year ended March 31, 2021

(All amounts in ₹ lakhs, unless otherwise stated)

NOTE 42: FAIR VALUE MEASUREMENTS

(i) Financial instruments by category

	As at 31-Mar-21		As at 31-Mar-20	
	FVTPL *	Amortised cost	FVTPL *	Amortised cost
Financial assets				
Investments				
- Equity instruments	492.13	-	322.77	-
- Bonds	-	165.27	10.67	-
- National Saving Certificates	-	0.03	-	0.03
Trade receivables	-	22062.90	-	29531.52
Loans	-	3846.23	-	1849.78
Cash and bank balances	-	1791.01	-	3413.25
Security deposits	-	697.48	-	685.57
Earnest money deposits	-	49.98	-	53.58
Derivative financial assets	35.92	-	-	-
Other receivables	-	184.82	-	112.75
Total financial assets	528.05	28797.72	333.44	35646.48
Financial liabilities				
Borrowings	-	92685.91	-	153010.23
Trade payables	-	62412.98	-	75640.03
Capital creditors	-	1149.77	-	1894.29
Security deposits	-	446.86	-	391.14
Derivative financial liabilities	-	-	2.19	-
Lease liabilities	-	1325.53	-	1766.50
Other payables	-	3130.54	-	2939.99
Total financial liabilities	-	161151.59	2.19	235642.18

*Mandatorily required to be measured at FVTPL. There is no financial instrument which is designated as FVTPL.

(ii) Fair value hierarchy

This section explains the judgements and estimates made in determining the fair values of the financial instruments that are recognised and measured at fair value. To provide an indication about the reliability of the inputs used in determining fair value, the Company has classified its financial instruments into the three levels prescribed under the accounting standard. An explanation of each level follows underneath the table.

Financial assets and liabilities measured at fair value - recurring fair value measurements

	Note No.	Level 1	Level 2	Level 3	Total
As at 31 March 2021					
Financial assets					
- Investments in equity instruments at FVTPL (Quoted)	6	492.13	-	-	492.13
- Foreign exchange forward contract at FVTPL	9	-	35.92	-	35.92
		492.13	35.92	-	528.05

Notes to the Standalone Financial Statements

for the year ended March 31, 2021

(All amounts in ₹ lakhs, unless otherwise stated)

	Note No.	Level 1	Level 2	Level 3	Total
As at 31 March 2020					
Financial assets					
- Investments in equity instruments at FVTPL (Quoted)	6	322.77	-	-	322.77
- Investments in bonds at FVTPL	6	-	10.67	-	10.67
		322.77	10.67	-	333.44
Financial liabilities					
- Foreign exchange forward contract at FVTPL	17	-	2.19	-	2.19
		-	2.19	-	2.19

Level 1: Level 1 hierarchy includes financial instruments measured using quoted unadjusted market prices in active markets for identical assets or liabilities. This includes listed equity instruments that have quoted price. The fair value of all equity instruments which are traded in the stock exchanges is valued using the closing price as at the reporting date.

Level 2: The fair value of financial instruments that are not traded in an active market is determined using valuation techniques which maximise the use of observable market data and rely as little as possible on entity-specific estimates. If all significant inputs required to fair value an instrument are observable, the instrument is included in level 2.

Level 3: If one or more of the significant inputs is not based on observable market data, the instrument is included in level 3.

There are no transfers between levels 1 and 2 during the year.

(iii) Valuation technique used to determine fair value

Specific valuation techniques used to value financial instruments include:

- the fair value of derivatives (viz. foreign exchange forward contracts) is determined using market observable inputs, including prevalent forward rates for the maturities of the respective contracts and interest rate curves as indicated by banks and third parties.
- the fair value of bonds is determined using observable market data of yield to maturity and coupon rates of securities.

All of the resulting fair value estimates are included in level 2.

(iv) Valuation processes

The Corporate finance team has requisite knowledge and skills in valuation of financial instruments. The team headed by Group CFO directly reports to the audit committee on the fair value of financial instruments.

Notes to the Standalone Financial Statements

for the year ended March 31, 2021

(All amounts in ₹ lakhs, unless otherwise stated)

(v) Fair value of financial assets and liabilities that are not measured at fair value (but fair value disclosures are required)

Except as detailed in the following table, the management considers that the carrying amounts of financial assets and financial liabilities recognised in the financial statements approximate their fair values

	As at 31-Mar-21		As at 31-Mar-20	
	Carrying amount	Fair value	Carrying amount	Fair value
Financial assets				
Trade receivables	22062.90	22046.97	29531.52	29528.18
	22062.90	22046.97	29531.52	29528.18
Financial liabilities				
Trade payables	62412.98	62331.28	75640.03	75548.50
	62412.98	62331.28	75640.03	75548.50

Fair value hierarchy

	Level 1	Level 2	Level 3	Total
As at 31 March 2021				
Financial assets				
Trade receivables	-	-	22046.97	22046.97
	-	-	22046.97	22046.97
Financial liabilities				
Trade payables	-	-	62331.28	62331.28
	-	-	62331.28	62331.28
As at 31 March 2020				
Financial assets				
Trade receivables	-	-	29528.18	29528.18
	-	-	29528.18	29528.18
Financial liabilities				
Trade payables	-	-	75548.50	75548.50
	-	-	75548.50	75548.50

- (a) The fair values for trade receivables and trade payables which are expected to be settled after twelve months (including those which are within the operating cycle) are computed based on discounted cash flows. They are classified as level 3 fair values in the fair value hierarchy due to the inclusion of unobservable inputs including counterparty credit risk. The carrying amounts of the remaining trade receivables and trade payables are considered to be the same as their fair values, due to their short-term nature.

Notes to the Standalone Financial Statements

for the year ended March 31, 2021

(All amounts in ₹ lakhs, unless otherwise stated)

NOTE 43: GOVERNMENT GRANTS

(i) Government grants recognised in the financial statements

	Grants recognised in profit or loss			Grant recoverable	
	Year ended 31-Mar-21	Year ended 31-Mar-20	Treatment in financial statements	As at 31-Mar-21	As at 31-Mar-20
A Deferred government grants related to income					
a) Loans at below market interest rate aggregating to ₹ 36400 lakhs availed during financial year 2018-19 under the "Scheme for Extending Financial Assistance to Sugar Undertakings 2018" notified by the State Government of Uttar Pradesh.	1125.25	1350.33	Reduced from finance cost (note 30)	-	-
Total deferred government grants	1125.25	1350.33		-	-
B Other revenue government grants					
a) Financial assistance by Government of India under the Scheme for providing assistance to sugar mills for expenses on marketing costs including handling, upgrading and other processing costs and costs of international and internal transport and freight charges on export of sugar during the sugar season 2020-21.	545.00	-	Presented under "Other operating revenue" (note 24)	545.00	-
b) Financial assistance by Government of India under the Scheme for providing assistance to sugar mills for expenses on marketing costs including handling, upgrading and other processing costs and costs of international and internal transport and freight charges on export of sugar during the sugar season 2019-20.	17979.14	12967.82	Presented under "Other operating revenue" (note 24)	371.67	12967.82
c) Financial assistance of ₹ 13.88 per quintal of cane crushed during season 2018-19 by the Government of India under the "Scheme for Assistance to Sugar Mills".	-	8344.11	Presented under "Other operating revenue" (note 24)	-	4162.11
	-	2427.02	Reduced from Raw material consumed (note 26)	-	4162.11

Notes to the Standalone Financial Statements

for the year ended March 31, 2021

(All amounts in ₹ lakhs, unless otherwise stated)

	Grants recognised in profit or loss			Grant recoverable	
	Year ended 31-Mar-21	Year ended 31-Mar-20	Treatment in financial statements	As at 31-Mar-21	As at 31-Mar-20
d) Financial assistance by Government of India under the Scheme for defraying expenditure towards internal transport, freight, handling and other charges on export of sugar during the sugar season 2018-19.	-	2072.41	Presented under "Other operating revenue" (note 24)	-	1459.07
	-	1653.17	Reduced from outward freight and forwarding costs under "Other expenses" (note 33)	-	-
e) Financial assistance by Government of India under the Scheme for Creation and Maintenance of Buffer Stock of sugar.	200.64	1224.58	Depicted under "Other income" (note 25)	1897.71	2885.88
	1049.85	2848.01	Reduced from finance cost (note 30)		
f) Interest subvention @ 7% for one year by Government of India on soft loans of ₹ 31000 lakhs availed from banks under the scheme for soft loans to sugar mills	131.37	2044.58	Reduced from finance cost (note 30)	1025.26	1367.97
g) Interest subvention @ 50% of rate charged by lenders (subject to maximum of 6%) by Government of India on loans of ₹ 17693 lakhs availed from banks for distilleries under the "Scheme for extending financial assistance to sugar mills for enhancement and augmentation of ethanol production capacity"	749.33	671.00	Reduced from finance cost (note 30)	696.32	671.00
h) Export incentives under Duty Draw back Scheme, Incremental Export Incentive Scheme and Merchandise Export Incentive Scheme.	54.89	87.77	Presented under "Other operating revenue" (note 24)	35.22	28.73
Total other revenue government grants	20710.22	34340.47		4571.18	23542.58
Total government grants related to income	21835.47	35690.80		4571.18	23542.58

Notes to the Standalone Financial Statements

for the year ended March 31, 2021

(All amounts in ₹ lakhs, unless otherwise stated)

	Grants received		Treatment in financial statements	Grant recoverable	
	Year ended 31-Mar-21	Year ended 31-Mar-20		As at 31-Mar-21	As at 31-Mar-21
C Government grants related to assets					
a) Grant in respect of Moist Hot Air Treatment Plants (MHAT) and Soil treatment plant received from the State Government of Uttar Pradesh under Rashtriya Krishi Vikas Yojna.	-	7.00	Reduced from gross value of PPE upon receipt. Recognised in profit or loss by way of reduced depreciation (refer note 3 and 31)	-	-
b) Grant in respect of Effluent Treatment Plant from the State Government of Karnataka under Karnataka 2009-14 Industrial Policy.	11.59	-	Reduced from gross value of PPE upon receipt. Recognised in profit or loss by way of reduced depreciation (refer note 3 and 31)	-	-
c) Grant of ₹ 141.45 lakhs in the form of duties saved upon import of machinery during financial year 2017-18 under Export Promotion Capital Goods (EPCG) scheme.	-	-	Reduced from gross value of PPE upon fulfilment of export obligation(s). Recognised in profit or loss by way of reduced depreciation (refer note 3 and 31)	-	-
Total government grants related to assets	11.59	7.00		-	-

Notes to the Standalone Financial Statements

for the year ended March 31, 2021

(All amounts in ₹ lakhs, unless otherwise stated)

(ii) Movement of deferred government grants is provided here below:

	Year ended 31-Mar-21	Year ended 31-Mar-20
As at the beginning of the year	2946.77	4297.10
Recognised during the year	-	-
Released to the statement of profit and loss	(1125.25)	(1350.33)
As at the end of the year	1821.52	2946.77
Current (refer note 19)	858.92	1125.25
Non-current (refer note 19)	962.60	1821.52
Total	1821.52	2946.77

NOTE 44: LEASES
As Lessee

The Company had acquired a land with original lease term of ninety years and had paid one-time payment of lease charges (i.e. the market value of the land) in respect of this lease at the inception of lease. There are no further future lease maintenance payments, no contingent rent or restriction imposed under the lease agreement and the Company has transfer rights in respect of such land. In terms of criteria specified in Ind AS 116 Leases, such lease has been recognised as Right-of-use assets (refer note 3).

Apart from above mentioned lease, assets taken under lease mainly includes various residential, office, godown premises and plots of land. These are generally not non-cancellable leases (except for few premises) having unexpired period upto ten years. The leases are renewable by mutual consent and on mutually agreeable terms. The Company has given refundable interest free security deposits under certain lease agreements. There is no contingent rent, sublease payments or restriction imposed in the lease agreement. In terms of criteria specified in AS 116 Leases, for some of these leases (i.e. leases other than with short term period or low value assets), present value of all future lease payments has been recognised as Right-of-use assets and lease liabilities with the charge for depreciation on Right-of-use assets and interest on lease liabilities in the statement of profit and loss (refer note 3 & 30) and for other leases, yearly lease payments has been expensed off on straight line basis over lease term as rent expenses (refer note 33).

Amounts recognised as expense

	Year ended 31-Mar-21	Year ended 31-Mar-20
Depreciation expense - Right-of-use assets (Land) (refer note 3)	5.69	5.40
Depreciation expense - Right-of-use assets (Building) (refer note 3)	552.39	626.64
Interest on lease liabilities (refer note 30)	147.12	185.93
Rent expense - short term leases (refer note 33)	195.68	164.72
Total	900.88	982.69

Total cash outflow for leases during the year ended 31 March 2021 is ₹ 911.31 lakhs (31 March 2020: ₹ 809.87 lakhs).

Commitments for short term leases as at 31 March 2021 is ₹ 57.41 lakhs (31 March 2020: ₹ 26.39 lakhs).

Notes to the Standalone Financial Statements

for the year ended March 31, 2021

(All amounts in ₹ lakhs, unless otherwise stated)

As Lessor

The Company has given certain portion of its office / factory premises under operating leases [including lease of investment property (refer note 4)]. These leases are not non-cancellable and are extendable by mutual consent and at mutually agreeable terms. The gross carrying amount, accumulated depreciation and depreciation recognised in the statement of profit and loss in respect of such portion of the leased premises are not separately identifiable. There is no impairment loss in respect of such premises. No contingent rent has been recognised in the statement of profit and loss. There are no minimum future lease payments as there are no non-cancellable leases. Lease income is recognised in the statement of profit and loss under "Other income" (refer note 25). Lease income earned by the Company from its investment properties and direct operating expenses arising on the investment properties for the year is set out in note 4.

NOTE 45: COMMITMENTS

	As at 31-Mar-21	As at 31-Mar-20
Estimated amount of contracts remaining to be executed on capital account and not provided for (after adjusting advances aggregating to ₹ 1671.66 lakhs (31 March 2020: ₹ 238.25 lakhs))	9530.44	733.11

NOTE 46: CONTINGENT LIABILITIES AND CONTINGENT ASSETS

Contingent liabilities

	As at 31-Mar-21	As at 31-Mar-20
--	--------------------	--------------------

Claims against the Company not acknowledged as debts:

i) Claims which are being contested by the Company and in respect of which the Company has paid amounts aggregating to ₹ 439.01 lakhs (31 March 2020: ₹ 407.89 lakhs), excluding interest, under protest pending final adjudication of the cases:	7852.59	7625.34
---	---------	---------

Sl. No.	Particulars	Amount of contingent liability		Amount paid	
		31-Mar-21	31-Mar-20	31-Mar-21	31-Mar-20
1	Sales tax	531.51	328.98	95.91	65.35
2	Excise duty	312.73	287.73	275.74	273.86
3	GST	-	0.59	-	0.59
4	Others*	7008.35	7008.04	67.36	68.09

*Amount of contingent liability includes ₹ 5973.50 lakhs as at 31 March 2021 (31 March 2020 : ₹ 5973.50 lakhs) in respect of interest on delayed payment of cane price for the sugar seasons 2012-13, 2013-14 and 2014-15 in respect of which the Hon'ble Allahabad High Court had passed an order directing the Cane Commissioner of the State to decide the matter afresh, taking into consideration certain additional factors. The Cane Commissioner is understood to have filed an affidavit in a contempt proceeding, specifying interest rates on delayed cane price payments but no such order of the Cane Commissioner has been served on the Company or industry association and such order, which if served may be legally challenged.

Notes to the Standalone Financial Statements

for the year ended March 31, 2021

(All amounts in ₹ lakhs, unless otherwise stated)

	As at 31-Mar-21	As at 31-Mar-20
(ii) The Company is contingently liable in respect of short provision against disputed income tax liabilities (excluding determination of final interest payable thereon) of ₹ 3060.70 lakhs (31 March 2020: ₹ 3182.47 lakhs) against which ₹ 1666.79 lakhs (31 March 2020: ₹ 1718.94 lakhs) stands paid. The disputed income tax liability mainly arises on the issue of taxability of unrealised incentives, majority of which have been held to be non-taxable in the first appeal filed by the Company against which the Department has filed appeals before the Tribunal.	3060.70	3182.47
(iii) Liability arising from claims / counter claims/ interest in arbitration/ court cases, claims of certain employees/ex-employees and in respect of service tax, if any, on certain activities of the Company which are being contested by the Company.	Indeterminate	Indeterminate

The amount shown above represent the best possible estimates arrived at on the basis of available information. The uncertainties, possible payments and reimbursements are dependent on the outcome of the different legal processes which have been invoked by the Company or the claimants, as the case may be, and therefore cannot be predicted accurately. The Company engages reputed professional advisors to protect its interests and has been advised that it has strong legal position against such disputes.

Contingent assets

Based on management analysis, there are no material contingent assets as at 31 March 2021 and as at 31 March 2020.

NOTE 47: DISCLOSURES OF MICRO ENTERPRISES AND SMALL ENTERPRISES

Based on the intimation received by the Company from its suppliers regarding their status under the Micro, Small and Medium Enterprises Development Act, 2006, the relevant information is provided here below:

	31-Mar-21	31-Mar-20
The principal amount and the interest due thereon remaining unpaid to any supplier at the end of each accounting year; as at the end of the year		
(i) Principal amount (refer note 17 & 21)	563.31	6.73
(ii) Interest due on above	-	-
The amount of interest paid by the buyer in terms of section 16 of Micro, Small and Medium Enterprises Development Act, 2006 (27 of 2006), along with the amount of the payment made to the supplier beyond the appointed day during each accounting year.	-	-
The amount of interest due and payable for the period of delay in making payment (which has been paid but beyond the appointed day during the year) but without adding the interest specified under the Micro, Small and Medium Enterprises Development Act, 2006	-	-
The amount of interest accrued and remaining unpaid at the end of each accounting year; and	-	-
The amount of further interest remaining due and payable even in the succeeding years, until such date when the interest dues above are actually paid to the small enterprise, for the purpose of disallowance of a deductible expenditure under section 23 of the Micro, Small and Medium Enterprises Development Act, 2006	-	-

Notes to the Standalone Financial Statements

for the year ended March 31, 2021

(All amounts in ₹ lakhs, unless otherwise stated)

NOTE 48: DISCLOSURE AS PER REGULATION 34(3) OF THE SEBI (LODR) REGULATIONS, 2015 (AS AMENDED)

	Financial year	Outstanding balance	Maximum amount due during the year
Loans & advances to subsidiaries			
- Mathura Wastewater Management Private Limited	31-Mar-21	2000.00	3530.00
	31-Mar-20	1510.00	1510.00
- United Shippers and Dredgers Limited*	31-Mar-21	44.53	44.53
	31-Mar-20	N.A.	N.A.
Loans & advances to associates			
- Aqwise Wise Water Technologies Limited	31-Mar-21	1831.47	2133.48
	31-Mar-20	291.53	291.53
Loans & advances to firms/companies in which directors are interested	31-Mar-21	-	-
	31-Mar-20	-	-
Investment by the loanee in the shares of Triveni Engineering & Industries Ltd. and its subsidiaries	31-Mar-21	-	-
	31-Mar-20	-	-

* Became subsidiary of the Company during the year

NOTE 49: COMPARATIVES

The Company has reclassified certain items of financials of comparative year to conform to this year's classification, however, impact of these reclassification are not material.

NOTE 50: APPROVAL OF STANDALONE FINANCIAL STATEMENTS

The standalone financial statements were approved for issue by the Board of Directors on 29 June 2021 subject to approval of shareholders.

As per our report of even date attached

For S S Kothari Mehta & Company
Chartered Accountants

Firm's registration number : 000756N

Yogesh K. Gupta

Partner

Membership No. 093214

Date : June 29, 2021

For and on behalf of the Board of Directors of Triveni Engineering & Industries Limited

Dhruv M. Sawhney

Chairman & Managing Director

Suresh Taneja

Group CFO

Homai A. Daruwalla

Director & Chairperson Audit Committee

Geeta Bhalla

Group Vice President & Company Secretary



Consolidated Financial Statements

Independent Auditor's Report

To
**The Members of
Triveni Engineering & Industries Limited**

REPORT ON THE AUDIT OF THE CONSOLIDATED FINANCIAL STATEMENTS

Opinion

We have audited the accompanying consolidated financial statements of **TRIVENI ENGINEERING & INDUSTRIES LIMITED** (hereinafter referred to as "the Holding Company") and its subsidiaries (the Holding Company and its subsidiaries together referred to as "the Group") and its associates, which comprise of the Consolidated Balance Sheet as at 31 March 2021, the Consolidated Statement of Profit and Loss (including Other Comprehensive Income), the Consolidated Statement of Cash Flows and Consolidated Statement of Changes in Equity for the year then ended and notes to the consolidated financial statements including a summary of the significant accounting policies and other explanatory information (hereinafter referred to as "the consolidated financial statements").

In our opinion and to the best of our information and according to the explanations given to us and based on the consideration of reports of other auditors on separate financial statements of the subsidiaries and associates as referred to in the Other Matters paragraph below, the aforesaid consolidated financial statements give the information required by the Companies Act, 2013 ("the Act") in the manner so required and give a true and fair view in conformity with the accounting principles

generally accepted in India, of the consolidated state of affairs of the Group and its associates as at 31 March 2021 and of consolidated profit including other comprehensive loss, consolidated changes in equity and its consolidated cash flows for the year ended on that date.

Basis for Opinion

We conducted our audit in accordance with the Standards on Auditing (SAs) specified under section 143(10) of the Act. Our responsibilities under those Standards are further described in the Auditor's Responsibilities for the Audit of the Consolidated Financial Statements section of our report. We are independent of the Group in accordance with the Code of Ethics issued by the Institute of Chartered Accountants of India and we have fulfilled our other ethical responsibilities in accordance with the provision of the Act. We believe that the audit evidence obtained by us and the audit evidence obtained by the other auditors in terms of their reports referred to in the Other Matters paragraph below is sufficient and appropriate to provide a basis for our audit opinion on the consolidated financial statements.

Key Audit Matters

Key audit matters are those matters that, in our professional judgment, were of most significance in our audit of the consolidated financial statements of the current period. These matters were addressed in the context of our audit of the consolidated financial statements as a whole, and in forming our opinion thereon, and we do not provide a separate opinion on these matters.

Sr. Key Audit Matters No.	Auditor's Response
<p>1. Recognition of Subsidies:</p> <p>We identified recognition of subsidies as a key audit matter as it involves significant management judgement. The area of management judgement includes management risk assessment with respect to recognition of subsidies based on substantive compliance of the conditions and reasonable certainty of receipt of subsidy. (Refer Note no. 2(a)(iii) & Note 43 of the consolidated financial statements)</p>	<p>Our audit procedures included the following:</p> <ul style="list-style-type: none"> • Obtaining policy from the Holding Company defining the management perspective and basis for recognition of Government subsidies in the books of accounts; • Obtaining an understanding of internal controls over recognition and recoverability of subsidy claims and testing, on a sample basis, their design, and implementation and operating effectiveness • Considered the relevant circulars/notifications issued by various authorities; and • Evaluated the management's assessment regarding the reasonable certainty for complying with the relevant conditions as specified in circulars/notifications issued by various authorities.

Sr. Key Audit Matters No.	Auditor's Response
<p>2. Appropriateness of cost to complete the project:</p> <p>The Group recognizes revenue from construction contracts on percentage of completion method as specified in Indian Accounting Standards (Ind AS) 115- Revenue from Contract with Customers. (Refer Accounting policy Note no. 1(b)(iii))</p> <p>We identified this matter as a key audit matter as it involves significant judgement by the management in estimation of cost to complete the project and any variation may have consequential impact on revenue.</p>	<p>Our audit procedures included the following:</p> <ul style="list-style-type: none"> • Obtaining an understanding of internal controls over estimation of cost of completion of projects and testing, on a sample basis, their design, implementation and operating effectiveness; • Agreed the total project revenue estimates to contracts with customers; • Obtained computation of estimated costs to complete and the percentage of project completion and verified the same against the contracts on sample basis and also checked arithmetic accuracy of the same; • Performed the walkthrough procedure and verified the invoices, purchase orders etc. for actual cost incurred till the year end; and • Compared the management estimates revised during the year with the estimate made in earlier years and obtained reasons/approval for such revision.

Information other than the Consolidated Financial Statements and Auditor's Report thereon

The Holding Company's Board of Directors is responsible for the other information. The other information comprises the information included in the annual report but does not include the consolidated financial statements and our auditor's report thereon.

Our opinion on the consolidated financial statements does not cover the other information and we do not express any form of assurance conclusion thereon.

In connection with our audit of the consolidated financial statements, our responsibility is to read the other information and, in doing so, consider whether the other information is materially inconsistent with the consolidated financial statements, or our knowledge obtained during the course of our audit or otherwise appears to be materially misstated.

If, based on the work we have performed and based on the audit report of other auditors, we conclude that there is a material misstatement of this other information, we are required to report that fact. We have nothing to report in this regard.

Responsibility of Management and Those Charged with Governance for the Consolidated Financial Statements

The Holding Company's Board of Directors is responsible for the preparation and presentation of these consolidated financial statements in terms of the requirements of the Act

that give a true and fair view of the consolidated financial position, consolidated financial performance including other comprehensive income, consolidated cash flows and consolidated statement of changes in equity of the Group including its associates in accordance with the accounting principles generally accepted in India, including the Indian Accounting Standards prescribed under Section 133 of the Act, read with relevant rules issued thereunder. The respective Board of Directors of the companies included in the Group and of its associates are responsible for maintenance of adequate accounting records in accordance with the provisions of the Act for safeguarding the assets of the Group and its associates and for preventing and detecting frauds and other irregularities; the selection and application of appropriate accounting policies; making judgments and estimates that are reasonable and prudent; and the design, implementation and maintenance of adequate internal financial controls, that were operating effectively for ensuring the accuracy and completeness of the accounting records, relevant to the preparation and presentation of the consolidated financial statements that give a true and fair view and are free from material misstatement, whether due to fraud or error, which have been used for the purpose of preparation of the consolidated financial statements by the Directors of the Holding Company, as aforesaid.

In preparing the consolidated financial statements, the respective Board of Directors of the companies included in the Group and of its associates are responsible for assessing

the ability of the Group and of its associates to continue as a going concern, disclosing, as applicable, matters related to going concern and using the going concern basis of accounting unless management either intends to liquidate the Group or to cease operations, or has no realistic alternative but to do so.

The respective Board of Directors of the companies included in the Group and of its associates are responsible for overseeing the financial reporting process of the Group and of its associates.

Auditor's Responsibilities for the Audit of the Consolidated Financial Statements

Our objectives are to obtain reasonable assurance about whether the consolidated financial statements as a whole are free from material misstatement, whether due to fraud or error, and to issue an auditor's report that includes our opinion. Reasonable assurance is a high level of assurance, but is not a guarantee that an audit conducted in accordance with SAs will always detect a material misstatement when it exists. Misstatements can arise from fraud or error and are considered material if, individually or in the aggregate, they could reasonably be expected to influence the economic decisions of users taken on the basis of these consolidated financial statements.

As part of an audit in accordance with SAs, we exercise professional judgment and maintain professional skepticism throughout the audit. We also:

- Identify and assess the risks of material misstatement of the consolidated financial statements, whether due to fraud or error, design and perform audit procedures responsive to those risks, and obtain audit evidence that is sufficient and appropriate to provide a basis for our opinion. The risk of not detecting a material misstatement resulting from fraud is higher than for one resulting from error, as fraud may involve collusion, forgery, intentional omissions, misrepresentations, or the override of internal control.
- Obtain an understanding of internal control relevant to the audit in order to design audit procedures that are appropriate in the circumstances. Under section 143(3) (i) of the Act, we are also responsible for expressing our opinion on whether the company has adequate internal financial controls system in place and the operating effectiveness of such controls.
- Evaluate the appropriateness of accounting policies used and the reasonableness of accounting estimates and related disclosures made by management.

- Conclude on the appropriateness of management's use of the going concern basis of accounting and, based on the audit evidence obtained, whether a material uncertainty exists related to events or conditions that may cast significant doubt on the ability of the Group and its associates to continue as a going concern. If we conclude that a material uncertainty exists, we are required to draw attention in our auditor's report to the related disclosures in the consolidated financial statements or, if such disclosures are inadequate, to modify our opinion. Our conclusions are based on the audit evidence obtained up to the date of our auditor's report. However, future events or conditions may cause the Group and its associates to cease to continue as a going concern.
- Evaluate the overall presentation, structure and content of the consolidated financial statements, including the disclosures, and whether the consolidated financial statements represent the underlying transactions and events in a manner that achieves fair presentation.
- Obtain sufficient appropriate audit evidence regarding the financial information of the entities or business activities within the Group and its associates to express an opinion on the consolidated financial statements. We are responsible for the direction, supervision and performance of the audit of the financial statements of such entities included in the consolidated financial statements of which we are the independent auditors. For the other entities included in the consolidated financial statements, which have been audited by other auditors, such other auditors remain responsible for the direction, supervision and performance of the audits carried out by them. We remain solely responsible for our audit opinion.

Materiality is the magnitude of misstatements in the consolidated financial statements that, individually or in aggregate, makes it probable that the economic decisions of a reasonably knowledgeable user of the consolidated financial statements may be influenced. We consider quantitative materiality and qualitative factors in (i) planning the scope of our audit work and in evaluating the results of our work; and (ii) to evaluate the effect of any identified misstatements in the consolidated financial statements.

We communicate with those charged with governance of Holding Company and such other entities included in the consolidated financial statements of which we are the independent auditors regarding, among other matters, the planned scope and timing of the audit and significant audit

findings, including any significant deficiencies in internal control that we identify during our audit.

We also provide those charged with governance with a statement that we have complied with relevant ethical requirements regarding independence, and to communicate with them all relationships and other matters that may reasonably be thought to bear on our independence, and where applicable, related safeguards.

From the matters communicated with those charged with governance, we determine those matters that were of most significance in the audit of the consolidated financial statements of the current period and are therefore the key audit matters. We describe these matters in our auditor's report unless law or regulation precludes public disclosure about the matter or when, in extremely rare circumstances, we determine that a matter should not be communicated in our report because the adverse consequences of doing so would reasonably be expected to outweigh the public interest benefits of such communication.

Other Matters

- a) We did not audit the financial statements of eight subsidiaries, whose financial statements reflect total assets of ₹ 2,228.72 lacs as at 31 March 2021 and total revenue (including other income) of ₹ 0.98 lacs, total comprehensive income (comprising of profit and other comprehensive income) of ₹ (-) 14.57 lacs and net cash outflow of ₹ 72.57 lacs for the year ended on that date, as considered in the consolidated financial statements. The consolidated financial statements also include the Group's share of net profit (before other comprehensive income) of ₹ 2,228.85 lacs and other comprehensive income of ₹ 107.84 lacs for the year ended 31 March 2021, in respect of one associate. These financial statements have been audited by the other auditors whose reports have been furnished to us by the management and our opinion on the consolidated financial statements, in so far as it relates to the amounts and disclosures included in respect of aforesaid eight subsidiaries and one associate and our report in terms of sub-sections (3) and (11) of section 143 of the Act, in so far as it relates to the aforesaid eight subsidiaries and one associate, is based solely on the report of other auditors.
- b) The consolidated financial statements include the Group's share of net profit (before other comprehensive income) of ₹ (-) 2,107.81 lacs and other comprehensive income of ₹ (-) 139.72 lacs for the twelve months period ended 31 December 2020, in respect of one associate - Aqwise Wise Water Technologies Ltd, as the financial statements for the quarter ended March 31, 2021 were not available.

The Holding Company has entered into a share purchase agreement (SPA) on March 25, 2021 to divest its stake in this associate company and has classified investment in the associate as "Assets held for sale" (Refer note 13 to the Consolidated Financial Statements). This associate is located outside India whose financial statements and other financial information have been prepared in accordance with accounting principles generally accepted in its country and which have been audited by the other auditor under generally accepted auditing standards accepted in its country. The Holding Company's management has converted these financial statements of such associate located outside India from accounting principles generally accepted in its country to accounting principles generally accepted in India. Our opinion, in so far as it relates to the amounts and disclosures included in respect of this associate, is based solely on the reports of other auditor and certified converted financial statements by management.

Our opinion on the consolidated financial statements, and our report on Other Legal and Regulatory Requirements below, is not modified in respect of the above matters with respect to our reliance on the work done and the reports of the other auditors and the financial statements/ financial information certified by the management.

Report on Other Legal and Regulatory Requirements

As required by Section 143(3) of the Act, based on our audit and on consideration of the report of the other auditors on financial statements and the other financial information of subsidiaries and associates referred to in Other Matters paragraph, we report, to the extent applicable, that:

- a) We have sought and obtained all the information and explanations which to the best of our knowledge and belief were necessary for the purposes of our audit of the aforesaid consolidated financial statements.
- b) In our opinion, proper books of account as required by law, relating to preparation of the aforesaid consolidated financial statements, have been kept so far as it appears from our examination of those books and reports of the other auditors.
- c) The Consolidated Balance Sheet, the Consolidated Statement of Profit and Loss (including Other Comprehensive Income), the Consolidated Statement of Changes in Equity and the Consolidated Statement of Cash Flows dealt with by this Report are in agreement with the relevant books of account maintained for the purpose of preparation of the consolidated financial statements.

- d) In our opinion, the aforesaid consolidated financial statements comply with the Accounting Standards specified under Section 133 of the Act.
- e) On the basis of the written representations received from the directors of the Holding Company as on 31 March 2021 taken on record by the Board of Directors of the Holding Company and the reports of the statutory auditors of its subsidiary companies and associate company, incorporated in India, none of the directors of the Group companies and its associate company, incorporated in India, is disqualified as on 31 March 2021 from being appointed as a director in terms of Section 164 (2) of the Act.
- f) With respect to the adequacy of the internal financial controls with reference to financial statements of the Group and its associate company, incorporated in India, and the operating effectiveness of such controls, refer to our separate report in Annexure 'A'.
- g) With respect to the other matters to be included in the Auditor's Report in accordance with the requirements of section 197(16) of the Act, as amended:

In our opinion and to the best of our information and according to the explanations given to us, the remuneration paid by the Group and its associates, where applicable, to its directors during the year is in accordance with the provisions of section 197 of the Act.

- h) With respect to the other matters to be included in the Auditor's Report in accordance with Rule 11 of the Companies (Audit and Auditor's) Rules, 2014, in our

opinion and to the best of our information and according to the explanations given to us and based on consideration of the report of the other auditors on financial statements and also the other financial information of subsidiaries and its associate referred to in Other Matters paragraph:

- i. The consolidated financial statements disclose impact of pending litigations as at 31 March 2021 on the consolidated financial position of the Group and its associates – Refer Note no. 48 to the consolidated financial statements.
- ii. The Group and its associates have made provision, as required under the applicable law or accounting standards, for material foreseeable losses, if any on long-term contracts including long term derivative contracts.
- iii. There were no amounts which were required to be transferred, to the Investor Education and Protection Fund by the Group. In respect of associate company incorporated in India, there has been no delay in transferring amounts, required to be transferred, to the Investor Education and Protection Fund during the year ended 31 March 2021.

For **S S Kothari Mehta & Company**

Chartered Accountants
Firm Registration No. 000756N

Yogesh K. Gupta

Partner

Place: Faridabad (Haryana)

Date: June 29, 2021

Membership No.: 093214

UDIN: 21093214AAAAFC9764

“Annexure A” to the Independent Auditor’s Report of even date on the Consolidated Financial Statements of TRIVENI ENGINEERING & INDUSTRIES LIMITED

REPORT ON THE INTERNAL FINANCIAL CONTROLS UNDER CLAUSE (I) OF SUB-SECTION 3 OF SECTION 143 OF THE COMPANIES ACT, 2013 (“THE ACT”) AS REFERRED TO IN PARAGRAPH (F) OF ‘REPORT ON OTHER LEGAL AND REGULATORY REQUIREMENTS’

In conjunction with our audit of the consolidated financial statements of the Company as of and for the year ended 31 March 2021, we have audited the internal financial controls over financial reporting of TRIVENI ENGINEERING & INDUSTRIES LIMITED (hereinafter referred to as “the Holding Company”) and its subsidiary companies and its associate company, which are companies incorporated in India, as of that date.

MANAGEMENT’S RESPONSIBILITY FOR INTERNAL FINANCIAL CONTROLS

The respective Board of Directors of the Holding Company, its subsidiary companies and its associate company, which are companies incorporated in India, are responsible for establishing and maintaining internal financial controls based on the internal control with reference to financial statements criteria established by the Company considering the essential components of internal control stated in the Guidance Note on Audit of Internal Financial Controls Over Financial Reporting issued by the Institute of Chartered Accountants of India (ICAI). These responsibilities include the design, implementation and maintenance of adequate internal financial controls that were operating effectively for ensuring the orderly and efficient conduct of its business, including adherence to the respective company’s policies, the safeguarding of its assets, the prevention and detection of frauds and errors, the accuracy and completeness of the accounting records, and the timely preparation of reliable financial information, as required under the Act.

AUDITORS’ RESPONSIBILITY

Our responsibility is to express an opinion on the Company’s internal financial controls with reference to financial statements based on our audit. We conducted our audit in accordance with the Guidance Note on Audit of Internal Financial Controls Over Financial Reporting (the “Guidance Note”) issued by the ICAI and the Standards on Auditing prescribed under section 143(10) of the Act, to the extent applicable to an audit of internal financial controls. Those Standards and the Guidance Note require that we comply with ethical requirements and plan and perform the audit to obtain reasonable assurance about whether adequate internal financial controls with reference to

financial statements was established and maintained and if such controls operated effectively in all material respects.

Our audit involves performing procedures to obtain audit evidence about the adequacy of the internal financial controls system with reference to financial statements and their operating effectiveness. Our audit of internal financial controls with reference to financial statements included obtaining an understanding of internal financial controls with reference to financial statements, assessing the risk that a material weakness exists, and testing and evaluating the design and operating effectiveness of internal control based on the assessed risk. The procedures selected depend on the auditor’s judgment, including the assessment of the risks of material misstatement of the financial statements, whether due to fraud or error.

We believe that the audit evidence we have obtained and the audit evidence obtained by the other auditors in terms of their reports referred to in the Other Matters paragraph below, is sufficient and appropriate to provide a basis for our audit opinion on the Company’s internal financial controls system with reference to financial statements of the Company.

MEANING OF INTERNAL FINANCIAL CONTROLS WITH REFERENCE TO FINANCIAL STATEMENTS

A company’s internal financial control with reference to financial statements is a process designed to provide reasonable assurance regarding the reliability of financial reporting and the preparation of consolidated financial statements for external purposes in accordance with generally accepted accounting principles. A company’s internal financial control with reference to financial statements includes those policies and procedures that (1) pertain to the maintenance of records that, in reasonable detail, accurately and fairly reflect the transactions and dispositions of the assets of the company; (2) provide reasonable assurance that transactions are recorded as necessary to permit preparation of consolidated financial statements in accordance with generally accepted accounting principles, and that receipts and expenditures of the company are being made only in accordance with authorisations of management and directors of the company; and (3) provide reasonable assurance regarding prevention or timely detection of unauthorised acquisition, use, or disposition of the company’s assets that could have a material effect on the consolidated financial statements.

INHERENT LIMITATIONS OF INTERNAL FINANCIAL CONTROLS WITH REFERENCE TO FINANCIAL STATEMENTS

Because of the inherent limitations of internal financial controls with reference to financial statements, including the possibility of collusion or improper management override of controls, material misstatements due to error or fraud may occur and not be detected. Also, projections of any evaluation of the internal financial controls with reference to financial statements to future periods are subject to the risk that the internal financial control with reference to financial statements may become inadequate because of changes in conditions, or that the degree of compliance with the policies or may deteriorate.

OPINION

In our opinion, to the best of our information and according to the explanations given to us and based on the consideration of reports of other auditors, as referred to in Other Matters paragraph, the Holding Company, its subsidiary companies and its associate company which are companies incorporated in India, have, in all material respects, an adequate internal financial controls system with respect to financial statements and such internal financial controls with respect to financial

statements were operating effectively as at 31 March 2021, based on the internal control over financial reporting criteria established by the Company considering the essential components of internal control stated in the Guidance Note on Audit of Internal Financial Controls Over Financial Reporting issued by the Institute of Chartered Accountants of India.

OTHER MATTERS

Our aforesaid reports under Section 143(3) (i) of the Act on the adequacy and operating effectiveness of the internal financial controls over financial reporting in so far as it relates to the eight subsidiary companies and one associate company, which are companies incorporated in India, is based on the corresponding reports of the auditors of such companies incorporated in India. Our opinion is not modified in respect of this matter.

For **S S Kothari Mehta & Company**
Chartered Accountants
Firm Registration No. 000756N

Yogesh K. Gupta
Partner

Place: Faridabad (Haryana)
Date: June 29, 2021

Membership No.: 093214
UDIN: 21093214AAAAFC9764

Consolidated Balance Sheet

as at March 31, 2021

(All amounts in ₹ lakhs, unless otherwise stated)

	Note No.	As at 31-Mar-21	As at 31-Mar-20
ASSETS			
Non-current assets			
Property, plant and equipment	3	105898.21	107393.34
Capital work-in-progress	3	2223.43	2615.84
Investment property	4	1210.14	1167.07
Goodwill	5	68.23	-
Other intangible assets	5	123.68	93.12
Investments accounted for using the equity method	6 (a)	13907.92	13832.30
Financial assets			
i. Investments	6 (b)	658.43	333.47
ii. Trade receivables	7	11981.97	8106.13
iii. Loans	8	2.46	1.82
iv. Other financial assets	9	1396.68	917.92
Deferred tax assets (net)	23	27.31	18.15
Income tax assets (net)	22	1119.58	4391.23
Other non-current assets	10	2113.46	701.99
Total non-current assets		140731.50	139572.38
Current assets			
Inventories	11	173374.92	191212.69
Financial assets			
i. Trade receivables	7	20839.23	26796.04
ii. Cash and cash equivalents	12 (a)	1127.70	3203.61
iii. Bank balances other than cash and cash equivalents	12 (b)	131.88	84.47
iv. Loans	8	1843.77	337.96
v. Other financial assets	9	258.53	189.79
Other current assets	10	23027.45	43201.17
Assets held for sale	13	220603.48	265025.73
		660.21	3.05
Total current assets		221263.69	265028.78
Total assets		361995.19	404601.16
EQUITY AND LIABILITIES			
Equity			
Equity share capital	14	2417.57	2479.47
Other equity	15	153149.83	131387.37
Total equity		155567.40	133866.84
LIABILITIES			
Non-current liabilities			
Financial liabilities			
i. Borrowings	16	30890.94	44359.64
ii. Other financial liabilities	17	972.68	1221.63
Provisions	18	5175.34	4793.34
Deferred tax liabilities (net)	23	13409.15	7823.64
Other non-current liabilities	19	1071.11	1893.63
Total non-current liabilities		51519.22	60091.88
Current liabilities			
Financial liabilities			
i. Borrowings	20	56158.52	94343.87
ii. Trade payables	21		
(a) total outstanding dues of micro enterprises and small enterprises		538.57	6.73
(b) total outstanding dues of creditors other than micro enterprises and small enterprises		61891.35	75635.18
iii. Other financial liabilities	17	15760.72	20079.20
Other current liabilities	19	14919.61	16507.65
Provisions	18	3727.66	3182.95
Income tax liabilities (net)	22	1912.14	886.86
Total current liabilities		154908.57	210642.44
Total liabilities		206427.79	270734.32
Total equity and liabilities		361995.19	404601.16

The accompanying notes 1 to 51 form an integral part of these consolidated financial statements

As per our report of even date attached

For S S Kothari Mehta & Company
Chartered Accountants

Firm's registration number : 000756N

Yogesh K. Gupta

Partner

Membership No. 093214

For and on behalf of the Board of Directors of Triveni Engineering & Industries Limited
Dhruv M. Sawhney

Chairman & Managing Director

Suresh Taneja

Group CFO

Homai A. Daruwalla

Director & Chairperson Audit Committee

Geeta Bhalla

Group Vice President & Company Secretary

Date : June 29, 2021

Consolidated Statement of Profit and Loss

for the year ended March 31, 2021

(All amounts in ₹ lakhs, unless otherwise stated)

	Note No.	Year ended 31-Mar-21	Year ended 31-Mar-20
Revenue from operations	24	470335.14	443663.22
Other income	25	3039.84	3626.42
Total income		473374.98	447289.64
Expenses			
Cost of materials consumed	26	321491.82	301067.82
Purchases of stock-in-trade	27	2200.73	2229.42
Changes in inventories of finished goods, stock-in-trade and work-in-progress	28	19914.26	21882.64
Excise duty on sale of goods		2917.60	-
Employee benefits expense	29	27076.59	25576.42
Finance costs	30	5163.17	7933.13
Depreciation and amortisation expense	31	7908.76	7489.12
Impairment loss on financial assets (including reversals of impairment losses)	32	340.18	861.47
Other expenses	33	40573.35	37727.16
Total expenses		427586.46	404767.18
Profit before share of net profits of investments accounted for using equity method and tax		45788.52	42522.46
Share of net profit of associates accounted for using the equity method	45	121.04	2038.61
Profit before exceptional items and tax		45909.56	44561.07
Exceptional items	34	66.95	-
Profit before tax		45976.51	44561.07
Tax expense:			
- Current tax	35	10924.39	7910.46
- Deferred tax	35	5591.85	3138.79
Total tax expense		16516.24	11049.25
Profit for the year		29460.27	33511.82
Other comprehensive income			
A (i) Items that will not be reclassified to profit or loss			
- Remeasurements of the defined benefit plan	38	(44.36)	(147.86)
- Share of other comprehensive income of associates accounted for using the equity method	45	24.18	(11.57)
		(20.18)	(159.43)
A (ii) Income tax relating to items that will not be reclassified to profit or loss	35	(15.50)	(51.67)
		(4.68)	(107.76)
B (i) Items that may be reclassified to profit or loss			
- Share of other comprehensive income of associates accounted for using the equity method (pertaining to exchange differences arising on translating the foreign operations)	45	(141.36)	(24.11)
- Share of other comprehensive income of associates accounted for using the equity method (pertaining to effective portion of profit/(loss) on designated portion of hedging instruments in a cash flow hedge)	45	85.30	(150.48)
		(56.06)	(174.59)
B (ii) Income tax relating to items that may be reclassified to profit or loss	35	-	-
		(56.06)	(174.59)
Other comprehensive income for the year, net of tax		(60.74)	(282.35)
Total comprehensive income for the year		29399.53	33229.47
Earnings per equity share (face value ₹ 1 each)			
Basic	36	12.01	13.32
Diluted	36	12.01	13.32

The accompanying notes 1 to 51 form an integral part of these consolidated financial statements

As per our report of even date attached

For S S Kothari Mehta & Company
Chartered Accountants

Firm's registration number : 000756N

Yogesh K. Gupta

Partner

Membership No. 093214

For and on behalf of the Board of Directors of Triveni Engineering & Industries Limited

Dhruv M. Sawhney

Chairman & Managing Director

Suresh Taneja

Group CFO

Homai A. Daruwalla

Director & Chairperson Audit Committee

Geeta Bhalla

Group Vice President & Company Secretary

Date : June 29, 2021

Consolidated Statement of Changes in Equity

for the year ended March 31, 2021

(All amounts in ₹ lakhs, unless otherwise stated)

	Reserves and surplus				Items of other comprehensive income			Total other equity		
	Capital redemption reserve	Capital reserve	Securities premium	Amalgamation reserve	General reserve	Molasses storage fund reserve	Retained earnings		Foreign currency translation reserve	Cash flow hedging reserve
A. EQUITY SHARE CAPITAL										
Equity shares of ₹ 1 each issued, subscribed and fully paid up (including paid up value of ₹ 0.02 lakhs pertaining to forfeited shares)										
As at 31 March 2019									2579.47	
Extinguishment of shares upon buy-back [refer note 14 (iv)]									(100.00)	
As at 31 March 2020									2479.47	
Extinguishment of shares upon buy-back [refer note 14 (iv)]									(61.90)	
As at 31 March 2021									2417.57	
B. OTHER EQUITY										
Balance as at 31 March 2019	473.14	2706.77	26585.22	926.34	49919.43	216.36	30599.11	(30.72)	77.36	111473.01
Profit/(loss) for the year	-	-	-	-	-	-	33511.82	-	-	33511.82
Other comprehensive income, net of income tax	-	-	-	-	-	-	(96.19)	-	-	(96.19)
Share of other comprehensive income of associates	-	-	-	-	-	-	(11.57)	(24.11)	(150.48)	(186.16)
Total comprehensive income for the year	-	-	0.67	-	-	-	33404.06	(24.11)	(150.48)	33229.47
Share of associates	-	-	-	-	-	21.60	(21.60)	-	-	0.67
Transferred from retained earnings to molasses storage fund reserve	-	-	-	-	-	(97.25)	97.25	-	-	-
Withdrawal from molasses storage fund reserve	-	-	-	-	-	-	-	-	-	-
Transactions with owners in their capacity as owners :										
- Amount utilised for buy-back of equity shares [refer note 14(iv)]	100.00	-	(9900.00)	-	-	-	-	-	-	(9900.00)
- Transferred from securities premium to capital redemption reserve on buy-back of equity shares [refer note 14(iv)]	-	-	(100.00)	-	-	-	-	-	-	-
- Transaction costs related to buy-back of equity shares [refer note 14(iv)]	-	-	(127.76)	-	-	-	-	-	-	(127.76)
- Dividends paid	-	-	-	-	-	-	(2727.40)	-	-	(2727.40)
- Dividend distribution tax	-	-	-	-	-	-	(660.62)	-	-	(660.62)
Balance as at 31 March 2020	573.14	2706.77	16458.13	926.34	49919.43	140.71	60790.80	(54.83)	(73.12)	131387.37
Profit/(loss) for the year	-	-	-	-	-	-	29460.27	-	-	29460.27
Other comprehensive income, net of income tax	-	-	-	-	-	-	(28.86)	-	-	(28.86)
Share of other comprehensive income of associates	-	-	-	-	-	-	24.18	(141.36)	85.30	(31.88)
Total comprehensive income for the year	-	-	0.01	-	-	-	29455.59	(141.36)	85.30	29399.53
Share of associates - additions	-	-	(38.97)	-	-	-	-	-	221.55	0.01
Share of associates - adjustments consequent to divestment [refer note 13]	-	-	-	-	-	40.49	(40.49)	-	-	-
Transferred to molasses storage fund reserve	-	-	-	-	-	-	-	-	-	-
Transactions with owners in their capacity as owners :										
- Amount utilised for buy-back of equity shares [refer note 14(iv)]	61.90	-	(6437.60)	-	-	-	-	-	-	(6437.60)
- Transferred from securities premium to capital redemption reserve on buy-back of equity shares [refer note 14(iv)]	-	-	(61.90)	-	-	-	-	-	-	-
- Transaction costs related to buy-back of equity shares [refer note 14(iv)]	-	-	(87.68)	-	-	-	-	-	-	(87.68)
- Tax paid on buy-back of equity shares [refer note 14(iv)]	-	-	(1456.44)	-	-	-	-	-	-	(1456.44)
Balance as at 31 March 2021	635.04	2868.83	8375.55	926.34	49919.43	181.20	90205.90	25.36	12.18	153149.83

The accompanying notes 1 to 51 form an integral part of these consolidated financial statements

As per our report of even date attached

For S S Kothari Mehta & Company
Chartered Accountants

Firm's registration number : 000756N

Yogesh K. Gupta
 Partner

Membership No. 093214

Date : June 29, 2021

For and on behalf of the Board of Directors of Triveni Engineering & Industries Limited
Homai A. Daruwalla
 Director & Chairperson Audit Committee

Geeta Bhalla
 Group Vice President & Company Secretary

Dhruv M. Sawhney
 Chairman & Managing Director

Suresh Taneja
 Group CFO

Consolidated Statement of Cash Flows

for the year ended March 31, 2021

(All amounts in ₹ lakhs, unless otherwise stated)

	Year ended 31-Mar-21	Year ended 31-Mar-20
Cash flows from operating activities		
Profit before tax	45976.51	44561.07
Adjustments for :		
Share of net profit/(loss) of associate accounted for using the equity method	(121.04)	(2038.61)
Depreciation and amortisation expense	7908.76	7489.12
Bad debts written off - trade receivables carried at amortised cost	75.06	315.06
Impairment loss allowance on trade receivables and other financial assets (net of reversals)	265.12	546.41
Bad debts written off - non financial assets	10.00	17.36
Impairment loss allowance on non financial assets (net of reversals)	59.24	(8.65)
Provision for non moving/obsolete inventory (net of reversals)	(6.00)	(74.29)
Loss on sale/write off of inventory	15.77	200.44
Net fair value (gains)/losses on investments	(169.36)	61.77
Mark-to-market losses/(gains) on derivatives	(35.92)	2.19
Credit balances written back	(131.63)	(208.16)
Exceptional items - profit on disposal of investments of property	(66.95)	-
Unrealised losses/(gains) from changes in foreign exchange rates	25.38	(19.69)
Loss on sale/write off/impairment of property, plant and equipment	423.49	19.86
Net (profit)/loss on sale/redemption of investments	(0.02)	(0.10)
Interest income	(571.29)	(229.76)
Dividend income	(2.84)	(2.86)
Finance costs	5163.17	7933.13
Working capital adjustments :		
Change in inventories	17828.01	20527.06
Change in trade receivables	1713.75	(11967.85)
Change in other financial assets	3.22	(1.29)
Change in other assets	20126.42	(23643.88)
Change in trade payables	(13111.37)	12065.96
Change in other financial liabilities	356.36	105.30
Change in other liabilities	(1254.07)	2365.94
Change in provisions	882.34	277.59
Cash generated from operations	85362.11	58293.12
Income tax paid (net)	(6282.84)	(7258.10)
Net cash inflow from operating activities	79079.27	51035.02
Cash flows from investing activities		
Purchase of property, plant and equipment and intangible assets	(8924.48)	(11691.61)
Proceeds from sale of property, plant and equipment	237.47	87.73
Advance given against purchase of investments	-	(160.00)
Advance received against assets held for sale	-	10.00
Investments in subsidiaries	(24.00)	-
Investments (other than subsidiaries and associates)	(5.27)	-
Proceeds from sale of investment property	60.00	-
Proceeds from disposal/redemption of investments (other than subsidiaries and associates)	10.69	20.72
Purchase of investment property	(42.44)	-
Loan to associates	(1733.60)	-
Decrease/(increase) in deposits with banks	(489.72)	450.86
Interest received	122.26	201.89
Dividend received from associate	-	353.14
Other dividends received	2.84	2.86
Net cash outflow from investing activities	(10786.25)	(10724.41)

Consolidated Statement of Cash Flows (Contd.)

for the year ended March 31, 2021

(All amounts in ₹ lakhs, unless otherwise stated)

	Year ended 31-Mar-21	Year ended 31-Mar-20
Cash flows from financing activities		
Proceeds from long term borrowings	5693.09	21354.87
Repayment of long term borrowings	(23921.13)	(8932.63)
Increase/(decrease) in short term borrowings	(38230.97)	(29197.08)
Interest paid (other than on lease liabilities)	(5152.55)	(7729.61)
Payment of lease liabilities (interest portion)	(146.14)	(180.75)
Payment of lease liabilities (principal portion)	(567.62)	(467.59)
Buy-back of equity shares	(6499.50)	(10000.00)
Buy-back costs	(87.68)	(127.76)
Tax paid on buy-back of equity shares	(1456.44)	-
Dividend paid to Company's shareholders	-	(2727.40)
Dividend distribution tax	-	(560.62)
Net cash outflow from financing activities	(70368.94)	(38568.57)
Net increase/(decrease) in cash and cash equivalents	(2075.92)	1742.04
Cash and cash equivalents at the beginning of the year [refer note 12 (a)]	3203.61	1461.57
Addition on acquisition of a subsidiary	0.01	-
Cash and cash equivalents at the end of the year [refer note 12 (a)]	1127.70	3203.61

Reconciliation of liabilities arising from financing activities:

	Non-current borrowings (including current maturities and deferred grant related to borrowings)	Current borrowings	Interest payable (other than on lease liabilities)	Lease liabilities	Buy-back of equity shares (including tax thereon and buy- back costs)	Unpaid dividends
Balance as at 31 March 2019	49049.44	123540.95	169.69	-	-	-
Cash flows	12422.24	(29197.08)	(7729.61)	(648.34)	(10127.76)	(3288.02)
Finance costs accruals (including interest capitalised)	-	-	7797.40	185.93	-	-
Lease liabilities accruals	-	-	-	2228.91	-	-
Buy-back of equity shares (including tax thereon and buy-back costs) accruals	-	-	-	-	10127.76	-
Dividend distributions (including DDT) accruals	-	-	-	-	-	3288.02
Balance as at 31 March 2020	61471.68	94343.87	237.48	1766.50	-	-
Cash flows	(18228.04)	(38230.97)	(5152.55)	(713.76)	(8043.62)	-
Finance costs accruals (including interest capitalised)	-	-	5016.55	147.12	-	-
Lease liabilities accruals	-	-	-	125.67	-	-
Buy-back of equity shares (including tax thereon and buy-back costs) accruals	-	-	-	-	8043.62	-
Balance as at 31 March 2021	43243.64	56112.90	101.48	1325.53	-	-

The accompanying notes 1 to 51 form an integral part of these consolidated financial statements

As per our report of even date attached

For S S Kothari Mehta & Company
Chartered Accountants

Firm's registration number : 000756N

Yogesh K. Gupta

Partner

Membership No. 093214

For and on behalf of the Board of Directors of Triveni Engineering & Industries Limited
Dhruv M. Sawhney

Chairman & Managing Director

Suresh Taneja

Group CFO

Homai A. Daruwalla

Director & Chairperson Audit Committee

Geeta Bhalla

Group Vice President & Company Secretary

Date : June 29, 2021

Notes to the Consolidated Financial Statements

for the year ended March 31, 2021

(All amounts in ₹ lakhs, unless otherwise stated)

CORPORATE INFORMATION

The financial statements comprises of financial statements of Triveni Engineering & Industries Limited and its subsidiaries (collectively the “Group”) and the Group’s interest in associates. Triveni Engineering & Industries Limited (the “Company” or the “Parent”) is a company limited by shares, incorporated and domiciled in India. The Company’s equity shares are listed at two recognised stock exchanges in India (BSE and NSE). The registered office of the Company is located at Deoband, Distt. Saharanpur, Uttar Pradesh – 247554. The Group is engaged in diversified businesses, mainly categorised into two segments – Sugar & allied businesses and Engineering business. Sugar & allied businesses primarily comprises manufacture of sugar and distillation of alcohol. Engineering business primarily comprises manufacture of high speed gears, gearboxes and providing water/waste-water treatment solutions.

NOTE 1: SIGNIFICANT ACCOUNTING POLICIES

This note provides a list of the significant accounting policies adopted in the preparation of these financial statements. These policies have been consistently applied to all the years presented, unless otherwise stated.

(a) Basis of preparation and presentation

(i) Compliance with Ind AS

The financial statements comply in all material aspects with Indian Accounting Standards (Ind AS) notified under Section 133 of the Companies Act, 2013 (the Act) [Companies (Indian Accounting Standards) Rules, 2015 (as amended)] and other relevant provisions of the Act.

(ii) Historical cost convention

The financial statements have been prepared on an accrual basis under historical cost convention except for certain assets and liabilities that are measured at fair values at the end of each reporting period, as explained in the respective accounting policies described in subsequent paragraphs.

Historical cost is generally based on the fair value of the consideration given in exchange for goods and services.

Fair value is the price that would be received to sell an asset or paid to transfer a liability in an orderly transaction between market participants at the measurement date, regardless of whether that price

is directly observable or estimated using another valuation technique. In estimating the fair value of an asset or a liability, the Group takes into account the characteristics of the asset or liability if market participants would take those characteristics into account when pricing the asset or liability at the measurement date. Fair value for measurement and/or disclosure purposes in these financial statements is determined on such a basis, except for leasing transactions that are within the scope of Ind AS 116 Leases (see note 1(d)), and measurements that have some similarities to fair value but are not fair value, such as net realisable value in Ind AS 2 Inventories (see note 1(l)) or value in use in Ind AS 36 Impairment of Assets (see note 1(f)).

(iii) Classification of assets and liabilities into current/non-current

All assets and liabilities have been classified as current or non-current as per the Group’s normal operating cycle and other criteria set out in Schedule III to the Act. The operating cycle of the Group is the time between the acquisition of assets for processing and their realisation in cash or cash equivalents.

(iv) Principles of consolidation and equity accounting

Subsidiaries

Subsidiaries are all entities over which the Group has control. The Group controls an entity when the Group is exposed to, or has rights to, variable returns from its involvement with the entity and has the ability to affect those returns through its power to direct the relevant activities of the entity. Subsidiaries are fully consolidated from the date on which control is transferred to the Group. They are deconsolidated from the date that control ceases.

The financial statements of subsidiary company namely Triveni Foundation, incorporated under Section 8 of the Act are not considered for consolidation since the Group is not exposed to or has any right to variable returns from its involvement with this company.

The Group combines the financial statements of the Parent and its subsidiaries line by line adding

Notes to the Consolidated Financial Statements

for the year ended March 31, 2021

(All amounts in ₹ lakhs, unless otherwise stated)

together like items of assets, liabilities, equity, income and expenses. Inter-company transactions, balances and unrealised gains on transactions between group companies are eliminated. Unrealised losses are also eliminated unless the transaction provides evidence of an impairment of the transferred asset. Accounting policies of subsidiaries have been changed where necessary to ensure consistency with the policies adopted by the Group.

Associates

Associates are all entities over which the Group has significant influence but not control or joint control. This is generally the case where the Group holds between 20% and 50% of the voting rights.

Interests in associates are accounted for using the equity method, after being initially recognised at cost in the balance sheet.

Under the equity method of accounting, the investments are initially recognised at cost and adjusted thereafter to recognise the Group's share of the post-acquisition profits or losses of the investee in profit or loss, the Group's share of other comprehensive income of the investee in other comprehensive income and the Group's share of other changes in other equity of the investee directly in other equity. Dividends received or receivable from associates are recognised as a reduction in the carrying amount of the investment.

When the Group's share of losses in an equity-accounted investment equals or exceeds its interest in the entity, including any other unsecured long-term receivables, the Group does not recognise further losses, unless it has incurred obligations or made payments on behalf of the other entity.

Unrealised gains on transactions between the Group and its associates are eliminated to the extent of the Group's interest in these entities. Unrealised losses are also eliminated unless the transaction provides evidence of an impairment of the asset transferred.

Changes in ownership interests

The group treats transactions with non-controlling interests that do not result in a loss of control as transactions with equity owners of the Group. A change in ownership interest results in an adjustment between the carrying amounts of the controlling and non-controlling interests to reflect their relative interests in the subsidiary. Any difference between the amount of the adjustment to non-controlling interests and any consideration paid or received is recognised within equity.

When the Group ceases to consolidate or equity account for an investment because of a loss of control or significant influence, any retained interest in the entity is remeasured to its fair value with the change in carrying amount recognised in profit or loss. This fair value becomes the initial carrying amount for the purposes of subsequently accounting for the retained interest as an associate or financial asset. In addition, any amounts previously recognised in other comprehensive income in respect of that entity are accounted for as if the Group had directly disposed of the related assets or liabilities. This may mean that amounts previously recognised in other comprehensive income are reclassified to profit or loss.

If the ownership interest in an associate is reduced but significant influence is retained, only a proportionate share of the amounts previously recognised in other comprehensive income are reclassified to profit or loss where appropriate.

(b) Revenue recognition

Revenue from contracts with customers is recognised when control of the goods or services are transferred to the customer at an amount that reflects the consideration to which the Group expects to be entitled in exchange for those goods or services. Transaction price at which revenue is recognised is net of goods & services tax and amounts collected on behalf of third parties, if any and includes effect of variable consideration (viz. returns, rebates, trade allowances, credits, penalties etc.). Variable consideration is estimated using the expected value method or most likely amount as appropriate in a given circumstance and is included in the transaction price only to the extent it is highly probable

Notes to the Consolidated Financial Statements

for the year ended March 31, 2021

(All amounts in ₹ lakhs, unless otherwise stated)

that a significant revenue reversal in the amount of cumulative revenue recognised will not occur when the associated uncertainty with the variable consideration is subsequently resolved.

Recognising revenue from major business activities

(i) Sale of goods

Revenue from the sale of goods is recognised at the point in time when control of the goods are transferred to the customer (i.e. satisfaction of performance obligation), generally on dispatch of the goods. The Group, in its engineering business, generally provides warranties to its customers in the nature of assurance, which is considered as an obligation and provided for under Ind AS 37 Provisions, Contingent Liabilities and Contingent Assets (refer note 1(n)).

(ii) Rendering of services

The Group provides engineering services that are either sold separately or bundled together with the sale of goods to a customer.

Contracts for bundled sales of goods and engineering services are comprised of two performance obligations because the promises to transfer goods and provide engineering services are distinct and capable of being separately identifiable. Accordingly, the Group allocates the transaction price based on relative stand-alone selling prices of such goods and engineering services.

The Group recognises revenue from engineering services over time, using an input method to measure progress towards complete satisfaction of the service, because the customer simultaneously receives and consumes the benefits provided by the Group. The progress towards complete satisfaction of the service is determined as follows:

- erection & commissioning / servicing revenue - based on technical estimate of completion of physical proportion of the contract work;
- operation & maintenance revenue - as the proportion of the total period of services contract that has elapsed at the end of the reporting period

(iii) Construction contracts

Construction contracts are analysed to determine combination of contracts and identification of performance obligations and accordingly transaction price is allocated amongst performance obligations based on stand-alone selling prices. Performance obligations, in construction contracts, generally includes construction/ turnkey related activities and operation & maintenance related activities which are satisfied over time with the customer receiving benefits from the activities being performed by the Group.

When the progress towards complete satisfaction of performance obligations of a construction contract can be estimated reliably, revenue is recognised by reference to the stage of completion of the contract activity at the end of the reporting period, measured based on the proportion of contract costs incurred for work performed to date relative to the estimated total contract costs, because the customer simultaneously receives and consumes the benefits provided by the Group. Contract costs excludes costs that do not depict the Company's progress in satisfying the performance obligation.

When the outcome of performance obligations of a construction contract cannot be estimated reliably, but the Group expects to recover the costs incurred in satisfying the performance obligation, contract revenue is recognised only to the extent of the contract costs incurred until such time that it can reasonably measure the outcome of the performance obligation. Contract costs are recognised as expenses in the period in which they are incurred.

(iv) Dividend income

Dividend income from investments is recognised when the Group's right to receive payment has been established.

(v) Interest income

Interest income is accrued on a time basis, by reference to the principal outstanding and at the effective interest rate applicable, which is the rate that exactly discounts estimated future cash receipts through the expected life of the financial

Notes to the Consolidated Financial Statements

for the year ended March 31, 2021

(All amounts in ₹ lakhs, unless otherwise stated)

asset to that asset's net carrying amount on initial recognition.

(c) Government grants

Grants from the government are recognised where there is a reasonable assurance that the Group will comply with all attached conditions and the grant will be received.

Government grants relating to income are deferred and recognised in the profit or loss over the period necessary to match them with the costs that they are intended to compensate and presented either within other operating income/other income or net of related costs.

Government grants relating to the purchase of property, plant and equipment are deducted from its gross value and are recognised in profit or loss on a systematic and rational basis over the expected useful lives of the related assets by way of reduced depreciation.

Government grants that are receivable as compensation for expenses or losses already incurred or for the purpose of giving immediate financial support to the Group with no future related costs are recognised in profit or loss in the period in which they become receivable.

The Government grants by way of a benefit of a Government loan at a below market rate of interest is measured as the difference between the proceeds received and the fair value of the loan based on prevailing market interest rates.

See note 43 for disclosures and treatment of government grants in financial statements.

(d) Leases

(i) As a lessee

The Group's lease assets classes primarily consist of leases for land and buildings. The Group assesses whether a contract contains a lease, at inception of a contract. A contract is, or contains, a lease if the contract conveys the right to control the use of an identified asset for a period of time in exchange for consideration. To assess whether a contract conveys the right to control the use of an identified asset, the Group assesses whether: (i) the contract involves the use of an identified asset; (ii) the Group has substantially all of the economic

benefits from use of the asset through the period of the lease; and (iii) the Group has the right to direct the use of the asset.

At the date of commencement of the lease, the Group recognises a right-of-use ("ROU") assets and a corresponding lease liability for all lease arrangements in which it is a lessee, except for leases with a term of twelve months or less (short-term leases) and low value leases. The ROU assets are initially recognised at cost, which comprises the initial amount of the lease liability adjusted for any lease payments made at or prior to the commencement date of the lease plus any initial direct costs less any lease incentives. They are subsequently measured at cost less accumulated depreciation and impairment losses. ROU assets are depreciated from the commencement date on a straight-line basis over the shorter of the lease term and useful life of the underlying asset (see note 1(i) below) and is also evaluated for impairment (see note 1(f) below). The lease liability is measured at amortised cost at the present value of the future lease payments. The lease term includes (a) the non-cancellable period of the lease; (b) the period covered by an option to extend the lease, if it is reasonably certain that such option shall be exercised; and (c) the period covered by an option to terminate the lease, if it is reasonably certain that such option shall not be exercised. Lease liabilities are remeasured with a corresponding adjustment to the related ROU assets if the Group changes its assessment concerning the right to exercise its option of extending or terminating the lease provided to it under the relevant arrangement.

For short-term and low value leases as mentioned above, the Group recognises the lease payments as an operating expense on a straight-line basis over the term of the lease.

(ii) As a lessor

Leases are classified as finance leases whenever the terms of the lease transfer substantially all the risks and rewards of ownership to the lessee. All other leases are classified as operating leases. The Group has given certain portion of its office/factory premises under operating leases (refer note 46).

Notes to the Consolidated Financial Statements

for the year ended March 31, 2021

(All amounts in ₹ lakhs, unless otherwise stated)

Lease income from operating leases is recognised as income on a straight-line basis over the lease term. Initial direct costs incurred in negotiating and arranging an operating lease are added to the carrying amount of the leased asset and recognised on a straight-line basis over the lease term. Respective leased assets are included in the balance sheet based on their nature.

(e) Foreign currency translation

(i) Functional and presentation currency

Items included in the financial statements of each of the Group's entities are measured using the currency of the primary economic environment in which the entity operates ('the functional currency'). The financial statements are presented in Indian rupee (₹), which is the Group's functional and presentation currency unless stated otherwise.

(ii) Transactions and balances

Foreign currency transactions are translated into the functional currency using the exchange rates that approximates the actual rate at the date of respective transactions. Foreign exchange gains or losses resulting from the settlement of such transactions and from the translation of monetary assets and liabilities denominated in foreign currencies at year end exchange rates are recognised in profit or loss in the period in which they arise except for foreign exchange gains or losses on settlement or translation of foreign currency borrowings that are directly attributable to acquisition, construction or production of a qualifying asset, which are included in cost of those assets when they are regarded as an adjustment to interest costs on those foreign currency borrowings.

Foreign exchange gains or losses which are regarded as an adjustment to borrowing costs are presented in the statement of profit and loss within finance costs. All other foreign exchange gains and losses are presented in the statement of profit and loss on a net basis within other income or other expenses, as the case may be.

(iii) Group companies

The results and financial position of foreign operations (none of which has the currency of a

hyperinflationary economy) that have a functional currency different from the presentation currency are translated into the presentation currency as follows:

- assets and liabilities are translated at the closing rate at the date of that balance sheet
- income and expenses are translated at average exchange rates (unless this is not a reasonable approximation of the cumulative effect of the rates prevailing on the transaction dates, in which case income and expenses are translated at the dates of the transactions), and
- all resulting exchange differences are recognised in other comprehensive income.

On consolidation, exchange differences arising from the translation of any net investment in foreign entities, and of borrowings and other financial instruments designated as hedges of such investments, are recognised in other comprehensive income. When a foreign operation is sold, the associated exchange differences are reclassified to profit or loss, as part of the gain or loss on sale.

(f) Impairment of non-financial assets

Non-financial assets are tested for impairment whenever events or changes in circumstances indicate that the carrying amount may not be recoverable. An impairment loss is recognised for the amount by which the asset's carrying amount exceeds its recoverable amount. The recoverable amount is the higher of an asset's fair value less costs of disposal and value in use. In assessing value in use, the estimated future cash flows are discounted to their present value using a discount rate that reflects current market assessments of the time value of money and the risks specific to the asset. In determining fair value less costs of disposal, recent market transactions are taken into account. If no such transactions can be identified, an appropriate valuation model is used.

For the purposes of assessing impairment, assets are grouped at the lowest levels for which there are separately identifiable cash inflows which are largely independent of the cash inflows from other assets or

Notes to the Consolidated Financial Statements

for the year ended March 31, 2021

(All amounts in ₹ lakhs, unless otherwise stated)

groups of assets (cash-generating units). Non-financial assets that suffered an impairment are reviewed for possible reversal of the impairment at the end of each reporting period. When an impairment loss subsequently reverses, the carrying amount of the asset is increased to the revised estimate of its recoverable amount, so however that the increased carrying amount does not exceed the carrying amount that would have been determined had no impairment loss been recognised for the asset in prior years. A reversal of an impairment loss is recognised immediately in profit or loss.

(g) Borrowing costs

Borrowing costs directly attributable to the acquisition, construction or production of a qualifying asset are capitalised during the period of time that is required to complete and prepare the asset for its intended use or sale. Borrowing costs are not capitalised during extended periods in which active development of qualifying assets is suspended. Qualifying assets are assets that necessarily take a substantial period of time to get ready for their intended use or sale.

Other borrowing costs are expensed in the period in which they are incurred.

(h) Income tax

Income tax expense represents the sum of the tax currently payable and deferred tax.

(i) Current tax

The tax currently payable is based on taxable profit for the year. Taxable profit differs from 'profit before tax' as reported in the statement of profit and loss because of items of income or expense that are taxable or deductible in other years and items that are never taxable or deductible. The Group's current tax is calculated using tax rates that have been enacted or substantively enacted by the end of the reporting period.

(ii) Deferred tax

Deferred tax is recognised on temporary differences between the carrying amounts of assets and liabilities in the financial statements and the corresponding tax bases used in the computation of taxable profit. Deferred tax liabilities are generally recognised for all taxable temporary differences.

Deferred tax assets are generally recognised for all deductible temporary differences, the carry forward of unused tax credits and unused tax losses to the extent that it is probable that taxable profits will be available against which those deductible temporary differences, the carry forward of unused tax credits and unused tax losses can be utilised. Such deferred tax assets and liabilities are not recognised if the temporary difference arises from the initial recognition (other than in a business combination) of assets and liabilities in a transaction that affects neither the taxable profit nor the accounting profit. In addition, deferred tax liabilities are not recognised if the temporary difference arises from the initial recognition of goodwill.

Deferred tax liabilities are recognised for taxable temporary differences associated with investments in subsidiaries and interests in associates, except where the Group is able to control the reversal of the temporary difference and it is probable that the temporary difference will not reverse in the foreseeable future. Deferred tax assets arising from deductible temporary differences associated with such investments and interests are only recognised to the extent that it is probable that there will be sufficient taxable profits to utilise the benefits of the temporary differences and they are expected to reverse in the foreseeable future.

The carrying amount of deferred tax assets is reviewed at the end of each reporting period and reduced to the extent that it is no longer probable that sufficient taxable profits will be available to allow all or part of the asset to be recovered.

Deferred tax liabilities and assets are measured at the tax rates that are expected to apply in the period in which the liability is settled or the asset realised, based on tax rates (and tax laws) that have been enacted or substantively enacted by the end of the reporting period.

The measurement of deferred tax liabilities and assets reflects the tax consequences that would follow from the manner in which the Group expects, at the end of the reporting period, to recover or settle the carrying amount of its assets and liabilities.

Notes to the Consolidated Financial Statements

for the year ended March 31, 2021

(All amounts in ₹ lakhs, unless otherwise stated)

(iii) Current and deferred tax for the year

Current and deferred tax are recognised in profit or loss, except when they relate to items that are recognised in other comprehensive income or directly in equity, in which case, the current and deferred tax are also recognised in other comprehensive income or directly in equity respectively. Where current tax or deferred tax arises from the initial accounting for a business combination, the tax effect is included in the accounting for the business combination.

(i) Property, plant and equipment

Property, plant and equipment are tangible items that are held for use in the production or supply of goods and services, rental to others or for administrative purposes and are expected to be used during more than one period. The cost of an item of property, plant and equipment is recognised as an asset if and only if it is probable that future economic benefits associated with the item will flow to the Group and the cost of the item can be measured reliably. Freehold land is carried at cost. All other items of property, plant and equipment are stated at cost less accumulated depreciation and accumulated impairment losses, if any. Cost comprises purchase price after deducting trade discounts/rebates, government grants related to assets and including import duties and non-refundable purchase taxes, borrowing costs, any costs that is directly attributable to the bringing the asset to the location and condition necessary for it to be capable of operating in the manner intended by the management and costs of dismantling/removing the item and restoring the site on which it was located under an obligation. Subsequent costs are included in the asset's carrying amount or recognised as a separate asset, as appropriate, only when it is probable that future economic benefits associated with the item will flow to the Group and the cost of the item can be measured reliably.

Each part of item of property, plant and equipment, if significant in relation to the total cost of the item, is depreciated separately. Further, parts of plant and equipment that are technically advised to be replaced at prescribed intervals/period of operation, insurance spares and cost of inspection/overhauling are depreciated separately based on their specific useful life provided these are of significant amounts

commensurate with the size of the Group and scale of its operations. The carrying amount of any equipment / inspection / overhauling accounted for as separate asset is derecognised when replaced. All other repairs and maintenance costs are charged to profit or loss during the reporting period in which they are incurred.

An item of property, plant and equipment is derecognised upon disposal or when no future economic benefits are expected to arise from the continued use of the asset. Any gain or loss arising on the disposal or retirement of an item of property, plant and equipment is determined as the difference between the sales proceeds and the carrying amount of the asset and is recognised in profit or loss.

Transition to Ind AS

On transition to Ind AS, the Group has elected to continue with the carrying value of all of its property, plant and equipment recognised as at 1 April 2015 (transition date) measured as per the previous GAAP and use that carrying value as the deemed cost of the property, plant and equipment.

Depreciation methods, estimated useful lives and residual value

Depreciation commences when the assets are available for their intended use. Depreciation is calculated using the straight-line method to allocate their cost, net of their residual values, over their estimated useful lives.

The management has estimated the useful lives and residual values of all property, plant and equipment and adopted useful lives as stated in Schedule II along with residual values of 5% except for the following:

- On the basis of technical assessment and past experience:
 - the useful lives of mill rollers, instrumentation and control devices installed at sugar plants is considered at ten years as against prescribed life of twenty five years in respect of continuous process plant.
 - mobile phones costing ₹ 5,000/- or more are depreciated over two years.

Notes to the Consolidated Financial Statements

for the year ended March 31, 2021

(All amounts in ₹ lakhs, unless otherwise stated)

- patterns, tools, Jigs etc. are depreciated over three years.
- machinery spares are depreciated over a life ranging from five to ten years.
- Assets costing less than ₹ 5,000/- are fully depreciated in the year of purchase.

Estimated useful lives considered are as follows:

Assets	Estimated useful life
Buildings	3 - 60 years
Roads	3 - 10 years
Plant & equipment	3 - 25 years
Furniture & fixtures	10 years
Vehicles	8 - 10 years
Office equipment	2 - 5 years
Computers	3 - 6 years
Laboratory equipment	10 years
Electrical installations and equipment	10 years

Fixture and fittings and improvements to leasehold buildings not owned by the Group are amortised over the unexpired lease period or estimated useful life of such fixture, fittings and improvements, whichever is lower.

The estimated useful lives, residual values and depreciation method are reviewed at the end of each reporting period, with the effect of any changes in estimate accounted for on a prospective basis.

(j) Investment property

Property that is held for long-term rental yields or for capital appreciation or both, is classified as investment property. Investment property is stated at cost less accumulated depreciation and accumulated impairment losses, if any. Investment property is measured initially at its cost, including related transaction costs and, where applicable, borrowing costs. Cost comprises purchase price after deducting trade discounts/rebates, government grants related to assets and including duties and taxes, borrowing costs, any costs that is directly attributable to the bringing the asset to the location and condition necessary for it to be capable of operating in the manner intended by management and costs of dismantling/removing the item and restoring the site on

which it was located under an obligation. Subsequent expenditure is capitalised to the asset's carrying amount only when it is probable that future economic benefits associated with the expenditure will flow to the Group and the cost of the item can be measured reliably. All other repairs and maintenance costs are expensed when incurred.

An investment property is derecognised upon disposal or when the investment property is permanently withdrawn from use and no future economic benefits are expected from the disposal. Any gain or loss arising on derecognition of the property (calculated as the difference between the net disposal proceeds and the carrying amount of the asset) is included in profit or loss in the period in which the property is derecognised.

Investment property being building is depreciated using the straight-line method over their estimated useful lives as stated in Schedule II at 30 years along with residual values of 5%.

Transition to Ind AS

On transition to Ind AS, the Group has elected to continue with the carrying value of all of its investment properties recognised as at 1 April 2015 (transition date) measured as per the previous GAAP and use that carrying value as the deemed cost of investment properties.

(k) Intangible assets

Intangible assets are carried at cost less accumulated amortisation and accumulated impairment losses, if any. Costs comprises purchase price after deducting trade discounts/rebates, government grants related to assets and including import duties and non-refundable purchase taxes, borrowing costs and any directly attributable cost of preparing the asset for its intended use. Subsequent costs are included in the asset's carrying amount or recognised as a separate asset, as appropriate, only when it is probable that future economic benefits associated with the item will flow to the Company and the cost of the item can be measured reliably. Intangible assets being computer software is amortised using straight-line method over estimated useful life of 3 years. The estimated useful life and amortisation method are reviewed at the end of each reporting period, with the effect of any changes in estimate being accounted for on a prospective basis.

Notes to the Consolidated Financial Statements

for the year ended March 31, 2021

(All amounts in ₹ lakhs, unless otherwise stated)

An intangible asset is derecognised on disposal, or when no future economic benefits are expected from use or disposal. Gains or losses arising from derecognition of an intangible asset, measured as the difference between the net disposal proceeds and the carrying amount of the asset, is recognised in profit or loss when the asset is derecognised.

Transition to Ind AS

On transition to Ind AS, the Group has elected to continue with the carrying value of all of intangible assets recognised as at 1 April 2015 measured as per the previous GAAP and use that carrying value as the deemed cost of intangible assets.

(l) Inventories

- (i) Finished goods and work-in-progress are valued at lower of cost and net realisable value. The cost of finished goods and work-in-progress is computed on weighted average basis and includes raw material costs, direct cost of conversion and proportionate allocation of indirect costs incurred in bringing the inventories to their present location and condition. Finished goods and work-in-progress are written down if their net realisable value declines below the carrying amount of the inventories and such write downs of inventories are recognised in profit or loss. When reasons for such write downs ceases to exist, the write downs are reversed through profit or loss.
- (ii) Inventories of raw materials & components, stores & spares and stock-in-trade are valued at lower of cost and net realisable value. Raw materials and other items held for use in the production of inventories are not written down below cost if the finished goods in which they will be incorporated are expected to be sold at or above cost. Write down of such inventories are recognised in profit or loss and when reasons for such write downs ceases to exist, such write downs are reversed through profit or loss. Cost of such inventories comprises of purchase price and other directly attributable costs that have been incurred in bringing the inventories to their present location and condition. By-products used as raw material are valued at transfer price linked with net realisable value. Cost for the purpose

of valuation of raw materials & components, stores & spares and stock-in-trade is considered on the following basis :

Raw materials & Components

Business Units	Basis
Sugar	First in first out
Co-generation & Distillery	Weighted average
Water Business Group	Specific cost
Power Transmission Business	Weighted average and Specific cost

Raw materials & Components

Business Units	Basis
Water Business Group	Specific cost
Other units	Weighted average

Stock-in-trade

Business Units	Basis
Branded goods trading business	Weighted average
Diesel/petrol retailing business	First in first out

- (iii) By-products (excluding those used as raw materials) and scrap are valued at estimated net realisable value.

(m) Non-current assets held for sale

Non-current assets are classified as held for sale if their carrying amount will be recovered principally through a sale transaction rather than through continuing use. This condition is regarded as met only when the asset is available for immediate sale in its present condition subject only to terms that are usual and customary for sales of such asset and its sale is highly probable. They are measured at the lower of their carrying amount and fair value less costs to sell. Non-current assets once classified as held for sale are neither depreciated nor amortised.

(n) Provisions, contingent liabilities and contingent assets

- (i) Provisions are recognised when the Group has a present obligation (legal or constructive) as a result

Notes to the Consolidated Financial Statements

for the year ended March 31, 2021

(All amounts in ₹ lakhs, unless otherwise stated)

of a past event, it is probable that the Group will be required to settle the obligation, and a reliable estimate can be made of the amount of the obligation. The amount recognised as a provision is the best estimate of the consideration required to settle the present obligation at the end of the reporting period, taking into account the risks and uncertainties surrounding the obligation. When the effect of the time value of money is material, provision is measured at the present value of cash flows estimated to settle the present obligation. When some or all of the economic benefits required to settle a provision are expected to be recovered from a third party, a receivable is recognised as an asset if it is virtually certain that reimbursement will be received and the amount of the receivable can be measured reliably.

- (ii) A contingent liability is not recognised in the financial statements, however, is disclosed, unless the possibility of an outflow of resources embodying economic benefits is remote. If it becomes probable that an outflow of future economic benefits will be required for an item dealt with as a contingent liability, a provision is recognised in the financial statements of the period (except in the extremely rare circumstances where no reliable estimate can be made).
- (iii) A contingent asset is not recognised in the financial statements, however, is disclosed, where an inflow of economic benefits is probable. When the realisation of income is virtually certain, then the asset is no longer a contingent asset, and is recognised as an asset.
- (iv) Provisions, contingent liabilities and contingent assets are reviewed at each balance sheet date.

(o) Employee benefits

(i) Short-term obligations

Liabilities for wages and salaries, including non-monetary benefits that are expected to be settled wholly within twelve months after the end of the period in which the employees render the related service are recognised in respect of employees' services up to the end of the reporting period and are measured at the undiscounted amounts

expected to be paid when the liabilities are settled. The liabilities are presented as current benefit obligations in the balance sheet.

(ii) Other long-term employee benefit obligations

Other long-term employee benefits include earned leaves and sick leaves. The liabilities for earned leaves and sick leaves are not expected to be settled wholly within twelve months after the end of the period in which the employees render the related service. They are therefore measured at the present value of expected future payments to be made in respect of services provided by employees up to the end of the reporting period using the projected unit credit method, with actuarial valuations being carried out at the end of each annual reporting period. The benefits are discounted using the market yield on government bonds at the end of the reporting period that have maturity term approximating to the estimated term of the related obligation. Remeasurements as a result of experience adjustments and changes in actuarial assumptions are recognised in profit or loss. The obligations are presented as provisions in the balance sheet.

(iii) Post-employment obligations

The Group operates the following post-employment schemes:

- defined benefit plans towards payment of gratuity; and
- defined contribution plans towards employees' provident fund & employee pension scheme, employees' state insurance, superannuation scheme and national pension scheme.

Defined benefit plan

The Group provides for gratuity obligations through a defined benefit retirement plan (the 'Gratuity Plan') covering all employees. The Gratuity Plan provides a lump sum payment to vested employees at retirement/termination of employment or death of an employee, based on the respective employees' salary and years of employment with the Group.

The liability or asset recognised in the balance sheet in respect of the defined benefit plan is the

Notes to the Consolidated Financial Statements

for the year ended March 31, 2021

(All amounts in ₹ lakhs, unless otherwise stated)

present value of the defined benefit obligation at the end of the reporting period less the fair value of plan assets. The present value of the defined benefit obligation is determined using projected unit credit method by discounting the estimated future cash outflows with reference to market yield at the end of the reporting period on government bonds that have maturity term approximating the estimated term of the related obligation, through actuarial valuations carried out at the end of each annual reporting period.

The net interest cost is calculated by applying the discount rate to the net balance of the defined benefit obligation and the fair value of plan assets. Such net interest cost along with the current service cost and, if applicable, the past service cost and settlement gain/loss, is included in employee benefit expense in the statement of profit and loss. Remeasurement gains and losses arising from experience adjustments and changes in actuarial assumptions, comprising actuarial gains/losses and return on plan assets (excluding the amount recognised in net interest on the net defined liability), are recognised in the period in which they occur, directly in other comprehensive income. They are included in retained earnings in the statement of changes in equity and in the balance sheet.

Defined contribution plans

Defined contribution plans are retirement benefit plans under which the Group pays fixed contributions to separate entities (funds) or financial institutions or state managed benefit schemes. The Group has no further payment obligations once the contributions have been paid. The defined contributions plans are recognised as employee benefit expense when they are due. Prepaid contributions are recognised as an asset to the extent that a cash refund or a reduction in the future payments is available.

■ **Provident Fund Plan & Employee Pension Scheme**

The Group makes monthly contributions at prescribed rates towards Employees' Provident Fund/ Employees' Pension Scheme to a Fund administered and managed by the Government of India.

■ **Employee State Insurance**

The Group makes prescribed monthly contributions towards Employees' State Insurance Scheme.

■ **Superannuation Scheme**

The Group contributes towards a fund established to provide superannuation benefit to certain employees in terms of Group Superannuation Policy entered into by such fund with the Life Insurance Corporation of India.

■ **National Pension Scheme**

The Group makes contributions to the National Pension Scheme fund in respect of certain employees of the Group.

(p) **Dividends**

Provision is made for the amount of any dividend declared, being appropriately authorised and no longer at the discretion of the Group, on or before the end of the reporting period but not distributed by the end of the reporting period.

(q) **Financial assets**

(i) **Classification**

The Group classifies its financial assets in the following measurement categories:

- those to be measured subsequently at fair value (either through other comprehensive income, or through profit or loss), and
- those measured at amortised cost.

The classification depends on the Group's business model for managing the financial assets and the contractual terms of the cash flows.

For assets measured at fair value, gains and losses will either be recorded in profit or loss or other comprehensive income. For assets in the nature of debt instruments, this will depend on the business model. For assets in the nature of equity instruments, this will depend on whether the Group has made an irrevocable election at the time of initial recognition to account for the equity instrument at fair value through other comprehensive income.

Notes to the Consolidated Financial Statements

for the year ended March 31, 2021

(All amounts in ₹ lakhs, unless otherwise stated)

The Group reclassifies debt instruments when and only when its business model for managing those assets changes.

(ii) Measurement

At initial recognition, the Group measures a financial asset at its fair value plus, in the case of a financial asset not at fair value through profit or loss, transaction costs that are directly attributable to the acquisition of the financial asset. Transaction costs of financial assets carried at fair value through profit or loss are expensed in profit or loss.

Debt instruments

Subsequent measurement of debt instruments depends on the Group's business model for managing the asset and the cash flow characteristics of the asset. There are three measurement categories into which the Group classifies its debt instruments:

- Amortised cost: Assets that are held for collection of contractual cash flows where those cash flows represent solely payments of principal and interest are measured at amortised cost. A gain or loss on a debt investment that is subsequently measured at amortised cost is recognised in profit or loss when the asset is derecognised or impaired. Interest income from these financial assets is recognised using the effective interest rate method.
- Fair value through other comprehensive income (FVTOCI): Assets that are held for collection of contractual cash flows and for selling the financial assets, where the assets' cash flows represent solely payments of principal and interest, are measured at FVTOCI. Movements in the carrying amount are taken through OCI, except for the recognition of impairment gains or losses, interest income and foreign exchange gains and losses which are recognised in profit or loss. When the financial asset is derecognised, the cumulative gain or loss previously recognised in OCI is reclassified from equity to profit or loss and recognised in other gains/(losses). Interest

income from these financial assets is included in other income using the effective interest rate method.

- Fair value through profit or loss (FVTPL): Assets that do not meet the criteria for amortised cost or FVTOCI are measured at fair value through profit or loss. A gain or loss on a debt investment that is subsequently measured at fair value through profit or loss is recognised in profit or loss and presented net in the statement of profit and loss within other gains/(losses) in the period in which it arises. Interest income from these financial assets is included in other income.

Equity instruments

The Group subsequently measures all equity investments at fair value, except for equity investments in associates where equity accounting is followed (note 1(a)(iv)). Where the Group's management has elected to present fair value gains and losses on equity investments in other comprehensive income, there is no subsequent reclassification of fair value gains and losses to profit or loss. Dividends from such investments are recognised in profit or loss as other income when the Group's right to receive payments is established.

(iii) Impairment of financial assets

In accordance with Ind AS 109 Financial Instruments, the Group applies expected credit loss (ECL) model for measurement and recognition of impairment loss associated with its financial assets carried at amortised cost and FVTOCI debt instruments.

For trade receivables or any contractual right to receive cash or another financial asset that result from transactions that are within the scope of Ind AS 115 Revenue from Contracts with Customers, the Group applies simplified approach permitted by Ind AS 109 Financial Instruments, which requires expected life time losses to be recognised after initial recognition of receivables. For recognition of impairment loss on other financial assets and risk

Notes to the Consolidated Financial Statements

for the year ended March 31, 2021

(All amounts in ₹ lakhs, unless otherwise stated)

exposure, the Group determines whether there has been a significant increase in the credit risk since initial recognition. If credit risk has not increased significantly, twelve months ECL is used to provide for impairment loss. However, if credit risk has increased significantly, lifetime ECL is used. If, in a subsequent period, credit quality of the instrument improves such that there is no longer a significant increase in credit risk since initial recognition, then the entity reverts to recognising impairment loss allowance based on twelve-months ECL.

ECL represents expected credit loss resulting from all possible defaults and is the difference between all contractual cash flows that are due to the Group in accordance with the contract and all the cash flows that the entity expects to receive, discounted at the original effective interest rate. While determining cash flows, cash flows from the sale of collateral held or other credit enhancements that are integral to the contractual terms are also considered.

ECL is determined with reference to historically observed default rates over the expected life of the trade receivables and is adjusted for forward looking estimates. Note 41(i) details how the Group determines expected credit loss.

(iv) Derecognition of financial assets

A financial asset is derecognised only when the Group

- has transferred the rights to receive cash flows from the financial asset; or
- retains the contractual rights to receive the cash flows of the financial asset, but assumes a contractual obligation to pay the cash flows to one or more recipients.

Where the Group has transferred an asset, it evaluates whether it has transferred substantially all risks and rewards of ownership of the financial asset. In such cases, the financial asset is derecognised. Where the Group has not transferred substantially all risks and rewards of ownership of the financial asset, the financial asset is not derecognised.

Where the Group has neither transferred a financial asset nor retained substantially all risks and rewards of ownership of the financial asset, the financial asset is derecognised if the Group has not retained control of the financial asset. Where the Group retains control of the financial asset, the asset is continued to be recognised to the extent of continuing involvement in the financial asset.

On derecognition of a financial asset in its entirety, the difference between the asset's carrying amount and the sum of the consideration received and receivable and the cumulative gain or loss that had been recognised in other comprehensive income and accumulated in equity is recognised in profit or loss if such gain or loss would have otherwise been recognised in profit or loss on disposal of that financial asset.

On derecognition of a financial asset other than in its entirety, the Group allocates the previous carrying amount of the financial asset between the part it continues to recognise under continuing involvement, and the part it no longer recognises on the basis of the relative fair values of those parts on the date of the transfer. The difference between the carrying amount allocated to the part that is no longer recognised and the sum of the consideration received for the part no longer recognised and any cumulative gain or loss allocated to it that had been recognised in other comprehensive income is recognised in profit or loss if such gain or loss would have otherwise been recognised in profit or loss on disposal of that financial asset. A cumulative gain or loss that had been recognised in other comprehensive income is allocated between the part that continues to be recognised and the part that is no longer recognised on the basis of the relative fair values of those parts.

(v) Effective interest method

The effective interest method is a method of calculating the amortised cost of a debt instrument and of allocating interest income over the relevant period. The effective interest rate is the rate that exactly discounts estimated future cash receipts through the expected life of the financial asset to the gross carrying amount of a financial asset. When

Notes to the Consolidated Financial Statements

for the year ended March 31, 2021

(All amounts in ₹ lakhs, unless otherwise stated)

calculating the effective interest rate, the Group estimates the expected cash flows by considering all the contractual terms of the financial instrument but does not consider the expected credit losses. Income is recognised on an effective interest basis for debt instruments other than those financial assets classified as at FVTPL.

(r) Financial liabilities and equity instruments

(i) Classification

Debt and equity instruments issued by the Group are classified as either financial liabilities or as equity in accordance with the substance of the contractual arrangements and the definitions of a financial liability and an equity instrument.

Equity instruments

An equity instrument is any contract that evidences a residual interest in the assets of the Group after deducting all of its liabilities.

Financial liabilities

The Group classifies its financial liabilities in the following measurement categories:

- those to be measured subsequently at fair value through profit or loss, and
- those measured at amortised cost.

Financial liabilities are classified as at FVTPL when the financial liability is held for trading or it is designated as at FVTPL, other financial liabilities are measured at amortised cost at the end of subsequent accounting periods.

(ii) Measurement

Equity instruments

Equity instruments issued by the Group are recognised at the proceeds received. Transaction cost of equity transactions shall be accounted for as a deduction from equity.

Financial liabilities

At initial recognition, the Group measures a financial liability at its fair value net of, in the case of a financial liability not measured at fair value through profit or loss, transaction costs that are directly attributable to the issue of the financial liability. Transaction

costs of financial liability carried at fair value through profit or loss are expensed in profit or loss.

Subsequent measurement of financial liabilities depends on the classification of financial liabilities. There are two measurement categories into which the Group classifies its financial liabilities:

- Fair value through profit or loss (FVTPL): Financial liabilities are classified as at FVTPL when the financial liability is held for trading or it is designated as at FVTPL. Financial liabilities at FVTPL are stated at fair value, with any gains or losses arising on remeasurement recognised in profit or loss.
- Amortised cost: Financial liabilities that are not held-for-trading and are not designated as at FVTPL are measured at amortised cost at the end of subsequent accounting periods. The carrying amounts of financial liabilities that are subsequently measured at amortised cost are determined based on the effective interest method. Interest expense that is not capitalised as part of costs of an asset is included in the 'Finance costs' line item.

(iii) Derecognition

Equity instruments

Repurchase of the Group's own equity instruments is recognised and deducted directly in equity. No gain or loss is recognised in profit or loss on the purchase, sale, issue or cancellation of the Group's own equity instruments.

Financial liabilities

The Group derecognises financial liabilities when, and only when, the Group's obligations are discharged, cancelled or have expired. An exchange with a lender of debt instruments with substantially different terms is accounted for as an extinguishment of the original financial liability and the recognition of a new financial liability. Similarly, a substantial modification of the terms of an existing financial liability (whether or not attributable to the financial difficulty of the debtor) is accounted for as an extinguishment of the original financial liability and the recognition of a new financial liability. The

Notes to the Consolidated Financial Statements

for the year ended March 31, 2021

(All amounts in ₹ lakhs, unless otherwise stated)

difference between the carrying amount of the financial liability derecognised and the consideration paid and payable is recognised in profit or loss.

(iv) Effective interest method

The effective interest method is a method of calculating the amortised cost of a financial liability and of allocating interest expense over the relevant period. The effective interest rate is the rate that exactly discounts estimated future cash payments through the expected life of the financial liability to the gross carrying amount of a financial liability.

(v) Foreign exchange gains and losses

For financial liabilities that are denominated in a foreign currency and are measured at amortised cost at the end of each reporting period, the foreign exchange gains and losses are determined based on the amortised cost of the instruments and are recognised in 'Other income'. The fair value of financial liabilities denominated in a foreign currency is determined in that foreign currency and translated at the spot rate at the end of the reporting period.

(s) Derivatives

Derivatives are initially recognised at fair value on the date a derivative contract is entered into and are subsequently re-measured to their fair value at the end of each reporting period. The resulting gain or loss is recognised in profit or loss immediately.

(t) Offsetting financial instruments

Financial assets and liabilities are offset and the net amount is reported in the balance sheet where there is a legally enforceable right to offset the recognised amounts and there is an intention to settle on a net basis or realise the asset and settle the liability simultaneously. The legally enforceable right must not be contingent on future events and must be enforceable in the normal course of business and in the event of default, insolvency or bankruptcy of the Group or the counterparty.

(u) Fair value of financial instruments

Fair value measurements are categorised into Level 1, 2 or 3 based on the degree to which the inputs to the fair value measurements are observable and the significance of the inputs to the fair value measurement in its entirety, which are described as follows:

- Level 1 inputs are quoted prices (unadjusted) in active markets for identical assets or liabilities that the Group can access at the measurement date;
- Level 2 inputs are inputs, other than quoted prices included within Level 1, that are observable for the asset or liability, either directly or indirectly; and
- Level 3 inputs are unobservable inputs for the asset or liability.

(v) Statement of cash flows

Cash flows are reported using the indirect method, whereby profit/loss before tax is adjusted for the effects of transactions of a non-cash nature, any deferrals or accruals of past or future operating cash receipts or payments and item of income or expenses associated with investing or financing flows. The cash flows from operating, investing and financing activities of the Group are segregated.

(w) Cash and cash equivalents

Cash and cash equivalents in the balance sheet comprise of cash on hand, cheques on hand, balance with banks on current accounts and short term, highly liquid investments with an original maturity of three months or less and which carry insignificant risk of change in value.

For the purpose of statement of cash flows, cash and cash equivalents consist of cash and cash equivalents as defined above.

(x) Earnings per share

Basic earnings per share is calculated by dividing the profit attributable to owners of the Company by the weighted average number of equity shares outstanding during the financial year, adjusted for bonus elements in equity shares issued during the year and excluding treasury shares.

Diluted earnings per share adjusts the figures used in the determination of basic earnings per share to take into account the after income tax effect of interest and financing costs associated with dilutive potential equity shares and the weighted average number of additional equity shares that would have been outstanding assuming the conversion of all dilutive potential equity shares.

Notes to the Consolidated Financial Statements

for the year ended March 31, 2021

(All amounts in ₹ lakhs, unless otherwise stated)

(y) Segment reporting

Operating segments are reported in a manner consistent with the internal reporting provided to the chief operating decision maker. Refer note 37 for segment information presented.

NOTE 2: CRITICAL ACCOUNTING JUDGEMENTS AND KEY SOURCES OF ESTIMATION UNCERTAINTY

The preparation of financial statements requires the use of accounting estimates which, by definition, will seldom equal the actual results. Management also needs to exercise judgement in applying the Group's accounting policies.

This note provides an overview of the areas that involved a higher degree of judgement or complexity and of items which are more likely to be materially adjusted due to estimates and assumptions turning out to be different than those originally assessed.

Estimates and judgements are continually evaluated. They are based on historical experience and other factors, including expectations of future events that may have a financial impact on the Group and that are believed to be reasonable under the circumstances.

(a) Critical accounting judgements

Following are the areas which involved complex and subjective judgements:

(i) Incentives under the U.P. Sugar Industry Promotion Policy, 2004

In a writ petition filed by the Company against the illegal withdrawal of U.P. Sugar Industry Promotion Policy, 2004 ("the Policy") by the State Government of Uttar Pradesh, the Hon'ble Allahabad High Court had decided the matter in favour of the Company and directed the State Government to quantify and pay all the incentives that were promised under the said Policy. The State Government however filed a Special Leave Petition before the Hon'ble Supreme Court challenging the decision of the Hon'ble High Court against it.

While the case was sub-judice, the Company continued to avail the remissions of statutory levies and duties aggregating to ₹ 4158.38 lakhs, which it was entitled to under the Policy, in accordance with the interim directions of the High Court. Based

on the aforesaid decision of Hon'ble Allahabad High Court in its favour, the Company is pursuing for its claim of ₹ 11375 lakhs filed towards one time capital subsidy and shall pursue its claims towards other incentives by way of reimbursements against specified expenses aggregating to ₹ 13015.88 lakhs, by filing necessary documents for the verification of the State Government authorities. The aforesaid amounts do not include any interest towards delayed settlement.

In view of uncertainties involved on account of the fact that the State Government has challenged the decision rendered against it and since the process of verification and quantification of claims by the State Government for the incentive period of 10 years is yet to be taken up, the Company has not recognised the above benefits/incentives receivable under the Policy.

(ii) Society commission

In the cane price package offered by the State Government of Uttar Pradesh ("State Government") to sugar mills, the State Government had reduced the rate of commission payable to cane societies for sugar season 2012-13 and 2014-15 by way of notification dated 12 June 2015 and for 2015-16 vide notification dated 5 February 2016, to provide relief to the Sugar Industry in view of disparity in the cane price and the market outlook of the sugar prices. In the writ petitions filed by certain cane societies against such reduction in commission rates, the Hon'ble Allahabad High Court has held that these notifications cannot have retrospective applicability. The reduction in the rate of commission payable being part of the relief package announced by the State Government, the Group believes that the State Government is not likely to pass the cost burden upon the sugar industry and instead, may explore other ways to meet the outcome of the order of the Court. Accordingly, no provision to this effect has been considered necessary.

(iii) Central Government subsidies

As a measure of relief to the sugar industry, to facilitate export and for speedy cane payments, the Central Government has announced incentives to the sugar industry for the sugar season 2020-21

Notes to the Consolidated Financial Statements

for the year ended March 31, 2021

(All amounts in ₹ lakhs, unless otherwise stated)

whereby sugar mills shall be entitled to assistance towards marketing and transportation costs related to export of sugar upto the Maximum Admissible Export Quantity (MAEQ) as determined by the Central Government and allocated to respective sugar mills. The incentives announced shall be made available to the sugar mills upon fulfilment of prescribed conditions and stipulations which mainly includes export of atleast 50% of its MAEQ of sugar. In addition, the Central Government has the power to withdraw/amend the scheme at any time, based upon its monitoring of prevailing sugar prices and review of availability position of sugar.

Upon assessment of the conditions prescribed, the Company has recognized such subsidy in respect of quantities of sugar for which substantive condition of the abovesaid scheme has been fulfilled (i.e. to the extent of sugar quantities of which export completed till the year end subject to the condition that such exports are atleast 50% of MAEQ allocated to specific sugar mill). The Company will recognise subsidy in subsequent period in respect of quantities of sugar for which export is under process as at the year end, on consideration of prudence. The estimated amount of subsidy in respect of such sugar in the process of export as at 31 March 2021 is ₹ 5700.08 lakhs.

(b) Key sources of estimation uncertainty

Following are the key assumptions concerning the future, and other key sources of estimation uncertainty at the end of the reporting period that may have a significant risk of causing a material adjustment to the carrying amounts of assets and liabilities within the next financial year:

(i) Global health pandemic from COVID-19

The outbreak of COVID-19 pandemic in India during last year has caused significant disturbance and slowdown of economic activity. During the period of lockdown in the first quarter of the financial year, the main business of the Company i.e. Sugar business, comprising manufacture of sugar and allied activities of cogeneration of power and distillation of ethanol, being essential goods, continued to operate uninterrupted. However, the engineering businesses were closed for about 3-5 weeks during that lockdown period subsequent to

which these have resumed normal operation by the second week of May'2020. The second wave of outbreak of COVID-19, which started towards the end of the financial year and continued subsequent to the closure of the financial year, has impacted the operations of engineering businesses to some extent due to precautionary steps taken to safeguard our employees, disturbance in supply chain due to impact of pandemic at vendor's end, reduced availability of labour and non-supply of oxygen for industrial purposes in the first quarter of the financial year 2021-22. The Company has evaluated the impact of this pandemic on its business operations and financial position using internal and external sources of information, including economic forecasts and estimates from market sources, and based on its review of current indicators of future economic conditions, there is no significant impact on carrying amount of the assets due to impairment and on its financial results for the year ended 31 March 2021. However, the impact assessment of COVID-19 is a continuing process given the uncertainties associated with its nature and duration and accordingly the impact may be different in future from that estimated as at the date of approval of these financial statements. The Company will continue to monitor any material changes to future economic conditions.

(ii) Fair value measurements and valuation processes

Some of the Group's assets and liabilities are measured at fair value for financial reporting purposes. When the fair values of these assets and liabilities cannot be measured based on quoted prices in active markets, their fair value is measured using valuation techniques by engaging third party qualified external valuers or internal valuation team to perform the valuation. The inputs to these models are taken from observable markets where possible, but where this is not feasible, a degree of judgement is required in establishing fair values. Judgements include considerations of inputs such as liquidity risk, credit risk and volatility. Changes in assumptions about these factors could affect the reported fair value of financial instruments. See note 4, 6, 9, 17 and 42 for further disclosures.

Notes to the Consolidated Financial Statements

for the year ended March 31, 2021

(All amounts in ₹ lakhs, unless otherwise stated)

(iii) Employee benefit plans

The cost of employee benefits under the defined benefit plan and other long term employee benefits as well as the present value of the obligation there against are determined using actuarial valuations. An actuarial valuation involves making various assumptions that may differ from actual developments in the future. These include the determination of the discount rate, future salary increases, attrition and mortality rates. Due to the complexities involved in the valuation and its long-term nature, obligation amount is highly sensitive to changes in these assumptions.

The parameter most subject to change is the discount rate. In determining the appropriate discount rate for plans, the management considers the market yields on government bonds with a maturity term that is consistent with the term of the concerned defined benefit obligation. Future salary increases are based on expected future inflation rates and expected salary trends in the industry. Attrition rates are considered based on past observable data of employees leaving the services of the Group. The mortality rate is based on publicly available mortality tables. Those mortality tables tend to change only at intervals in response to demographic changes. See note 38 for further disclosures.

(iv) Impairment of trade receivables

The Group has a stringent policy of ascertaining impairment, if any, as result of detailed scrutiny of major cases and through determining expected credit losses. Despite best estimates and periodic credit appraisals of customers, the Group's receivables are exposed to delinquency risks due to material adverse changes in business, financial or economic conditions that are expected to cause a significant change to the party's ability to meet its obligations. All such parameters relating to impairment or potential impairment are reviewed at each reporting date. See note 41(i) for further disclosures.

(v) Revenue and cost estimation for construction contracts

The revenue recognition pertaining to construction contracts are determined on proportionate completion method based on actual construction contract costs incurred till balance sheet date and total budgeted construction contract costs. An estimation of total budgeted construction contract cost involves making various assumptions that may differ from the actual developments in the future. These include delays in execution due to unforeseen reasons, inflation rate, future material rates, future labour rates etc. The estimates/assumptions are made considering past experience, market/inflation trends and technological developments etc. All such estimates/ assumptions are reviewed at each reporting date.

(vi) Provision for warranty claims

The Group, in the usual course of sale of its products, provides warranties on certain products and services, undertaking to repair or replace the items that fail to perform satisfactorily during the specified warranty period. Provisions made represent the amount of expected cost of meeting such obligations of rectifications / replacements based on best estimate considering the historical warranty claim information and any recent trends that may suggest future claims could differ from historical amounts. The assumptions made in relation to the current period are consistent with those in the prior years.

(vii) Provision for litigations and contingencies

The provision for litigations and contingencies are determined based on evaluation made by the management of the present obligation arising from past events the settlement of which is expected to result in outflow of resources embodying economic benefits, which involves judgements around estimating the ultimate outcome of such past events and measurement of the obligation amount.

(viii) Useful life and residual value of plant, property equipment and intangible assets

The useful life and residual value of plant, property equipment and intangible assets are

Notes to the Consolidated Financial Statements

for the year ended March 31, 2021

(All amounts in ₹ lakhs, unless otherwise stated)

determined based on technical evaluation made by the management of the expected usage of the asset, the physical wear and tear and technical or commercial obsolescence of the asset. Due to the judgements involved in such estimations, the useful life and residual value are sensitive to the actual usage in future period.

(ix) Current taxes and deferred taxes

Significant judgement is required in determination of taxability of certain incomes and deductibility of certain expenses during the estimation of the provision for income taxes.

Deferred tax assets are recognised for deductible temporary differences and carry forward of unused tax losses and tax credits to the extent that it is probable that taxable profit would be available against which such deferred tax assets could be utilised. Significant management judgement is required to determine the amount of deferred tax assets that can be recognised, based upon the likely timing and the level of future taxable profits together with future tax optimisation strategies.

Notes to the Consolidated Financial Statements

for the year ended March 31, 2021

(All amounts in ₹ lakhs, unless otherwise stated)

NOTE 3: PROPERTY, PLANT AND EQUIPMENT AND CAPITAL WORK-IN-PROGRESS

	Freehold Land		Leasehold Land use assets (Land)		Buildings & Roads		Right-of-use assets (Building)		Property, plant and equipment			Capital work-in-progress	
									Plant and Furniture	Vehicles	Office Equipment		Computers
Year ended 31 March 2020													
Gross carrying amount													
Opening gross carrying amount	3567.74	783.24	20682.72	77881.61	300.18	1239.08	381.68	561.53	105397.78	20533.58			
Opening reclassifications/recognitions	-	(349.66)	353.14	2232.26	-	-	-	-	2235.74	-	-	-	-
Additions	-	1553.17	1796.77	25.81	111.27	236.15	243.18	249.56	29731.96	5546.87			
Disposals	-	-	(10.09)	(68.28)	(156.91)	(1.81)	(97.96)	(11.25)	(359.08)	(83.21)			
Transfers *	-	-	-	-	-	-	-	-	-	(23408.30)			
Other adjustments	-	-	-	-	-	-	(0.48)	0.48	-	-			
Closing gross carrying amount	3567.74	1986.75	22469.40	2189.79	409.64	1377.27	611.60	800.32	137006.40	2638.94			
Accumulated depreciation and impairment													
Opening accumulated depreciation and impairment	-	18.56	2826.57	18573.56	167.65	372.32	153.49	293.63	22405.78	56.31			
Opening reclassifications/recognitions	-	(18.56)	-	-	-	-	-	-	-	-			
Depreciation charge during the year	-	5.40	984.32	5463.49	31.07	154.66	58.71	134.49	7458.78				
Disposals	-	-	(1.76)	(68.28)	(96.37)	(67.99)	(9.83)	(5.96)	(251.50)	(83.21)			
Other adjustments	-	-	-	-	-	-	(0.62)	0.62	-	-			
Closing accumulated depreciation and impairment	-	23.96	3809.13	558.36	197.35	459.05	201.75	422.78	29613.06	23.10			
Net carrying amount	3567.74	1986.75	18660.27	1631.43	79300.07	212.29	918.22	409.85	107393.34	2615.84			
Year ended 31 March 2021													
Gross carrying amount													
Opening gross carrying amount	3567.74	1986.75	22469.40	2189.79	103240.75	409.64	1377.27	611.60	137006.40	2638.94			
Additions	307.07	-	6.68	1285.33	132.81	4793.69	28.20	162.29	110.26	3867.93			
Disposals	-	-	(735.36)	(282.33)	(181.67)	(1.83)	(29.95)	(13.46)	(12.29)	(23.10)			
Transfers *	-	-	-	-	-	-	-	-	-	(4260.34)			
Closing gross carrying amount	3874.81	1986.75	25019.37	2040.27	107852.77	436.01	1509.61	708.40	142789.71	2223.43			
Accumulated depreciation and impairment													
Opening accumulated depreciation and impairment	-	-	23.96	3809.13	558.36	2394.68	197.35	459.05	201.75	422.78	29613.06	23.10	
Depreciation charge during the year	-	5.69	1084.54	552.39	5778.28	36.79	162.53	89.39	150.96	7860.57			
Disposals	-	-	(156.14)	(268.52)	(116.15)	(1.09)	(20.85)	(10.14)	(582.13)	(23.10)			
Closing accumulated depreciation and impairment	-	29.65	4737.53	842.23	29602.81	233.05	600.73	281.00	36891.50	-			
Net carrying amount	3874.81	1986.75	18281.84	1198.04	78249.96	202.96	908.88	427.40	105898.21	2223.43			

* Represents amount capitalised during the year under property, plant and equipment out of capital work-in-progress.

Notes:

- (i) **Leasehold land**
This comprises certain land acquired under agreements on perpetual lease terms from the Government and accordingly, classified and accounted for under Ind AS 16 Property, Plant and Equipment. Under the terms of the perpetual lease agreements, the Group has the right to sublet/ sub-lease/ assign/ transfer such land except in case of one perpetual lease relating to a small parcel of land where prior approval of the specified authority is required in case sub-lease/ assignment/ transfer relates to a part of such land demised under the lease.
- (ii) **Restrictions on Property, plant and equipment**
Refer note 16(i) & 20(i) for information on charges created on property, plant and equipment. Further, freehold land includes land having carrying amount of ₹ 13.13 lakhs for which transfer of titles in the name of the Company is pending.
- (iii) **Contractual commitments**
Refer note 47 for disclosure of contractual commitments for the acquisition of property, plant and equipment.
- (iv) **Capital work-in-progress**
Capital work-in-progress mainly comprises of a new distillery plant being constructed at Milak Narayanpur, building under construction (viz. sugar godown etc.) and plant & equipment (viz. Pollution control equipment etc.) under the process of installation pertaining to Sugar & Distillery business of the Group.

Notes to the Consolidated Financial Statements

for the year ended March 31, 2021

(All amounts in ₹ lakhs, unless otherwise stated)

NOTE 4: INVESTMENT PROPERTY

	As at 31-Mar-21	As at 31-Mar-20
Gross carrying amount		
Opening gross carrying amount	1167.07	1170.12
Additions	43.08	-
Classified as held for sale (refer note 13)	-	(3.05)
Closing gross carrying amount	1210.14	1167.07
Accumulated depreciation and impairment		
Opening accumulated depreciation	-	-
Depreciation charge/impairment losses	-	-
Closing accumulated depreciation and impairment	-	-
Net carrying amount	1210.14	1167.07

(i) Description about investment properties

Investment properties consist of :

- (a) various parcels of freehold land located in the states of Uttar Pradesh.
- (b) an office flat owned by the Group having carrying amount of ₹ 0.12 lakhs, constructed by a Society on a leasehold land at Mumbai.

(ii) Amount recognised in statement of profit and loss

	As at 31-Mar-21	As at 31-Mar-20
Rental income from office flat at Mumbai	13.56	15.24
Direct operating expenses on property that generated rental income	-	-
Direct operating expenses on property that did not generate rental income	(10.46)	(10.11)
Profit from investment properties before depreciation	3.10	5.13
Depreciation	-	-
Profit from investment properties	3.10	5.13

(iii) Restrictions on realisability and contractual obligations

Though the transfer of titles in the name of the Group is pending in respect of freehold land having carrying amount of ₹ 12.90 lakhs, the Group has no restrictions on the realisability of any of its investment properties and it is under no contractual obligations to either purchase, construct or develop investment properties or for repairs, maintenance and enhancements.

(iv) Fair value

	As at 31-Mar-21	As at 31-Mar-20
Investment properties		
- Various parcels of freehold land located in the states of Uttar Pradesh.	*	*
- Office flat at Mumbai	502.98	503.88

*The parcels of land owned by the Group are situated in the sugar belts of Uttar Pradesh. In view of slowdown in real estate and industrial activities, the circle rates may not be fully reflective of the fair value in the absence of transactions of similar properties (including size) in the vicinity of the subject properties.

Estimation of fair value of office flat at Mumbai

The valuation of the office flat situated at Mumbai has been carried by a registered approved valuer, conversant with and having knowledge of real estate activities in the concerned area, based on prevalent rates and other observable market inputs (Level 2 fair value).

Notes to the Consolidated Financial Statements

for the year ended March 31, 2021

(All amounts in ₹ lakhs, unless otherwise stated)

NOTE 5: INTANGIBLE ASSETS

	Goodwill	Computer software
Year ended 31 March 2020		
Gross carrying amount		
Opening gross carrying amount	-	287.18
Additions	-	77.24
Disposals	-	-
Closing gross carrying amount	-	364.42
Accumulated amortisation		
Opening accumulated amortisation	-	239.47
Amortisation charge for the year	-	31.83
Disposals	-	-
Closing accumulated amortisation	-	271.30
Closing net carrying amount	-	93.12
Year ended 31 March 2021		
Gross carrying amount		
Opening gross carrying amount	-	364.42
Additions	-	80.84
Acquisition of Subsidiary (see (i) below)	68.23	-
Disposals	-	(0.23)
Closing gross carrying amount	68.23	445.03
Accumulated amortisation		
Opening accumulated amortisation	-	271.30
Amortisation charge for the year	-	50.28
Disposals	-	(0.23)
Closing accumulated amortisation	-	321.35
Closing net carrying amount	68.23	123.68

- (i) Goodwill represents the excess of consideration paid over the net assets value of United Shippers & Dredgers Limited upon acquisition of its entire shareholding on March 25, 2021.

Notes to the Consolidated Financial Statements

for the year ended March 31, 2021

(All amounts in ₹ lakhs, unless otherwise stated)

NOTE 6: INVESTMENTS

(a) Investments accounted for using the equity method

	As at 31-Mar-21	As at 31-Mar-20
Quoted Investments (fully paid-up)		
Investments in Equity Instruments		
- of Associate		
70,627,980 (31 March 2020: 70,627,980) Equity shares of ₹ 1/- each of Triveni Turbine Limited [refer note 44(ii)]	13907.92	11571.24
Total aggregate quoted investments	13907.92	11571.24
Unquoted Investments (fully paid-up)		
Investments in Equity Instruments		
- of Associate		
Nil (31 March 2020: 13,008) Equity shares of New Israeli Shekel 0.10 each of Aqwise Wise Water Technologies Limited (Israel) [refer note 13 and 44(ii)]	-	2261.06
Total aggregate unquoted investments	-	2261.06
Total investments accounted for using the equity method	13907.92	13832.30
Total investments accounted for using the equity method	13907.92	13832.30
Aggregate amount of quoted investments	13907.92	11571.24
Aggregate amount of market value of quoted investment	71899.28	41317.37
Aggregate amount of unquoted investments	-	2261.06
Aggregate amount of impairment in the value of investments	-	-

(b) Other non-current investments

	As at 31-Mar-21	As at 31-Mar-20
At Cost		
Unquoted Investments (fully paid-up)		
Investments in Equity Instruments		
- of Subsidiaries		
100,000 (31 March 2020: Nil) Equity shares of ₹ 1/- each of Triveni Foundation (incorporated u/s 8 of the Companies Act, 2013)	1.00	-
Total other non-current investments carried at cost [A]	1.00	-
At Amortised cost		
Unquoted Investments (fully paid-up)		
Investments in Government or trust securities		
National Saving Certificates (kept as security)	0.03	0.03
Investments in Bonds		
2,000 (31 March 2020 : Nil) 9.25% bonds of ₹ 1,000/- of Dewan Housing Finance Corporation Ltd SR-V B	6.00	-
24,600 (31 March 2020 : Nil) 9.25% bonds of ₹ 1,000/- of Dewan Housing Finance Corporation Ltd SR-III	73.80	-

Notes to the Consolidated Financial Statements

for the year ended March 31, 2021

(All amounts in ₹ lakhs, unless otherwise stated)

	As at 31-Mar-21	As at 31-Mar-20
12,200 (31 March 2020 : Nil) 9.10% bonds of ₹ 1,000/- of Dewan Housing Finance Corporation Ltd. SR-VI A	36.60	-
500 (31 March 2020 : Nil) 9.30% bonds of ₹ 1,000/- of Dewan Housing Finance Corporation Ltd SR-VI B	1.50	-
2,000 (31 March 2020 : Nil) 9.55% of ₹ 1,000/- bonds of IL&FS Financial Services Ltd. SR-V	0.20	-
3,000 (31 March 2020 : Nil) 8.85% of ₹ 1,000/- bonds of IL&FS Financial Services Ltd. SR-VI	6.00	-
4,000 (31 March 2020 : Nil) 8.75% of ₹ 1,000/- bonds of IL&FS Financial Services Ltd. SR-III	8.00	-
9,700 (31 March 2020 : Nil) 8.65% of ₹ 1,000/- bonds of IL&FS Financial Services Ltd. SR-XVI	0.97	-
5,100 (31 March 2020 : Nil) 8.23% of ₹ 1,000/- bonds of IL&FS Financial Services Ltd. SR-I	10.20	-
2,000 (31 March 2020 : Nil) 8.70% of ₹ 1,000/- bonds of IL&FS Financial Services Ltd. SR-I	4.00	-
3,000 (31 March 2020 : Nil) 9.50% of ₹ 1,000/- bonds of Infrastructure Leasing & Financial Services Ltd. SR-II C	6.00	-
6,000 (31 March 2020 : Nil) 9.00% of ₹ 1,000/- bonds of Infrastructure Leasing & Financial Services Ltd. SR-I-H (O-1)	12.00	-
Total other non-current investments carried at amortised cost [B]	165.30	0.03
At Fair value through Profit or Loss (FVTPL) (refer note 42)		
Quoted Investments (fully paid-up)		
Investments in Equity Instruments		
13,500 (31 March 2020: 13,500) Equity shares of ₹ 2/- each of Housing Development Finance Corporation Limited	337.25	220.47
5,000 (31 March 2020: 5,000) Equity shares of ₹ 1/- each of HDFC Bank Limited	74.68	43.09
24,175 (31 March 2020: 24,175) Equity shares of ₹ 2/- each of Punjab National Bank	8.86	7.82
76 (31 March 2020 : 76) Equity shares of ₹ 10/- each of Central Bank of India	0.01	0.01
3,642 (31 March 2020: 3,642) Equity shares of ₹ 5/- each of NBI Industrial Finance Co. Limited	71.33	51.38
Total aggregate quoted investments	492.13	322.77
Unquoted Investments (fully paid-up)		
Investments in Bonds		
Nil (31 March 2020: 1) 8.57% bonds of ₹ 10 lakhs each of Central Bank of India	-	10.67
Total aggregate unquoted investments	-	10.67
Total other non-current investments carried at FVTPL [C]	492.13	333.44
Total other non-current investments ([A]+[B]+[C])	658.43	333.47
Total other non-current investments	658.43	333.47
Aggregate amount of quoted investments	492.13	322.77
Aggregate amount of market value of quoted investment	492.13	322.77
Aggregate amount of unquoted investments	166.30	10.70
Aggregate amount of impairment in the value of investments	-	-

Notes to the Consolidated Financial Statements

for the year ended March 31, 2021

(All amounts in ₹ lakhs, unless otherwise stated)

NOTE 7: TRADE RECEIVABLES

	As at 31-Mar-21		As at 31-Mar-20	
	Current	Non- current	Current	Non- current
Trade receivables (at amortised cost)				
- Considered good - Unsecured	20976.22	11981.97	26943.69	8106.13
- Trade receivables which have significant increase in credit risk	-	1004.59	-	614.57
- Trade receivables - Credit impaired	-	969.40	-	1039.11
Less: Allowance for bad and doubtful debts	(136.99)	(1973.99)	(147.65)	(1653.68)
Total trade receivables	20839.23	11981.97	26796.04	8106.13

- (i) Refer note 41(i) for credit risk, impairment of trade receivables under expected credit loss model and other related disclosures.
- (ii) Mathura Wastewater Management Private Limited (MWMPL), a subsidiary of the Company, was incorporated as a special purpose vehicle for implementation of a project/order awarded to the MWMPL under a contract entered into with U.P. Jal Nigam, Agra and National Mission for Clean Ganga under the Namami Gange Programme. The project is on hybrid annuity PPP basis, according to which 40% of EPC value will be paid by customer during the construction period and balance 60% will be paid during O&M period of 15 years alongwith interest.

NOTE 8: LOANS

	As at 31-Mar-21		As at 31-Mar-20	
	Current	Non- current	Current	Non- current
At amortised cost				
Loan to related parties (refer note 39)				
- Loans receivables considered good - Unsecured	1831.47	-	291.53	-
Loan to employees				
- Loans receivables considered good - Unsecured	11.74	2.46	45.86	1.82
Loan to others				
- Loans receivables considered good - Unsecured	0.56	-	0.57	-
- Loans receivables - Credit impaired	-	-	-	44.53
Less: Allowance for bad and doubtful loans	-	-	-	(44.53)
	0.56	-	0.57	-
Total loans	1843.77	2.46	337.96	1.82

- (i) Loan to related parties refers to loan provided to an Israeli based associate company, Aqwise Wise Water Technologies Limited, for meeting its working capital requirements (refer note 13).

Notes to the Consolidated Financial Statements

for the year ended March 31, 2021

(All amounts in ₹ lakhs, unless otherwise stated)

NOTE 9: OTHER FINANCIAL ASSETS

	As at 31-Mar-21		As at 31-Mar-20	
	Current	Non- current	Current	Non- current
At amortised cost				
Security deposits (see (i) below)	26.38	671.10	45.65	639.92
Earnest money deposits	48.13	2.00	51.73	2.00
Less: Allowance for bad and doubtful deposits	(0.15)	-	(0.15)	-
	47.98	2.00	51.58	2.00
Bank balances:				
Earmarked balances with banks:				
- Deposit against molasses storage fund (refer note 15(vi))	-	244.27	-	195.89
Balances under lien/margin/kept as security:				
- Post office savings account	-	0.19	-	0.19
- Fixed / margin deposits	-	474.24	-	73.82
Other balances:				
- Fixed deposits	-	4.20	-	4.20
	-	722.90	-	274.10
Accrued interest	17.72	0.68	34.65	1.90
Insurance claim recoverable	122.38	-	54.79	-
Miscellaneous other financial assets	8.15	14.90	3.12	14.90
Less: Allowance for bad and doubtful assets	-	(14.90)	-	(14.90)
	8.15	-	3.12	-
Total other financial assets at amortised cost [A]	222.61	1396.68	189.79	917.92
At fair value through Profit or Loss (FVTPL) (refer note 42)				
Derivatives financial instruments carried at fair value				
- Foreign exchange forward contracts	35.92	-	-	-
Total other financial assets at FVTPL [B]	35.92	-	-	-
Total other financial assets ([A]+[B])	258.53	1396.68	189.79	917.92

- (i) Investment of ₹ 82.95 lakhs (31 March 2020: ₹ 79.72 lakhs) in equity shares of Atria Wind Power (Bijapur1) Private Limited, under group captive arrangement to source power, has been considered as security deposit in accordance with applicable accounting standards.

Notes to the Consolidated Financial Statements

for the year ended March 31, 2021

(All amounts in ₹ lakhs, unless otherwise stated)

NOTE 10: OTHER ASSETS

	As at 31-Mar-21		As at 31-Mar-20	
	Current	Non- current	Current	Non- current
Capital advances	-	1671.66	-	238.25
Advances to suppliers	1105.33	18.06	1084.97	18.06
Less: Allowance for bad and doubtful advances	(54.89)	(18.06)	(54.89)	(18.06)
	1050.44	-	1030.08	-
Advances to related parties (refer note 39)	1.16	-	1.16	-
Indirect tax and duties recoverable	3505.69	314.69	2459.92	309.76
Less: Allowance for bad and doubtful amounts	(13.82)	(1.46)	(13.82)	(1.46)
	3491.87	313.23	2446.10	308.30
Deposit with sales tax authorities	166.95	6.55	142.73	6.55
Bank guarantee encashment recoverable	-	200.00	-	200.00
Less: Allowance for bad and doubtful claims	-	(200.00)	-	(200.00)
	-	-	-	-
Export incentives receivable	35.22	-	28.73	-
Less: Allowance for bad and doubtful claims	(7.46)	-	(7.46)	-
	27.76	-	21.27	-
Government grant receivables (refer note 43)	4535.96	-	23513.85	-
Advances to employees	41.37	1.45	30.55	1.45
Prepaid expenses	796.82	29.04	817.67	46.36
Due from customers under construction contracts [see (ii) below]	5611.67	-	7251.03	-
Unbilled revenue [see (ii) below]	23.17	-	144.30	-
Customer retentions [see (i) and (ii) below]	7251.59	-	7790.90	-
Less: Allowance for bad and doubtful debts	(121.02)	-	(61.66)	-
	7130.57	-	7729.24	-
Miscellaneous other assets	149.71	112.31	73.19	121.98
Less: Allowance for bad and doubtful assets	-	(20.78)	-	(20.90)
	149.71	91.53	73.19	101.08
Total other assets	23027.45	2113.46	43201.17	701.99

- (i) Customer retentions include ₹ 2139.68 lakhs (31 March 2020 : ₹ 5023.76 lakhs) expected to be received after twelve months within the operating cycle.

Notes to the Consolidated Financial Statements

for the year ended March 31, 2021

(All amounts in ₹ lakhs, unless otherwise stated)

(ii) Contract balances

	As at 31-Mar-21	As at 31-Mar-20
Contract assets		
- Amounts due from customers under construction contracts	5611.67	7251.03
- Unbilled revenue	23.17	144.30
- Customer retentions	7130.57	7729.24
Contract liabilities		
- Amounts due to customers under construction contracts	6064.42	6620.83
- Advance from customers	5151.28	5653.69

- (a) Contract assets are initially recognised for revenue earned but not billed pending successful achievement of milestones. Upon achievement of milestones contract assets are reclassified to trade receivables. A trade receivable represents the Group's right to an amount of consideration that is billed on the customer and which become due unconditionally (i.e. only the passage of time is required before payment of the consideration is due). Different businesses of the Group have their different credit terms [refer note 41 (i)].

Contract costs incurred to date plus recognised profits or less recognised losses are compared with progress billings raised on the customer - any surplus is considered as contract assets and shown as amounts due from customers under construction contracts, whereas any shortfall is considered as contract liabilities and shown as the amounts due to customers under construction contracts. Amounts of revenue earned for service work performed pending billing on customers is also considered as contract assets and shown as unbilled revenue. Amounts billed for work performed which will become due upon fulfillment of specified conditions is considered as contract assets and shown as customer retentions. Amounts received before the related work is performed is considered as contract liabilities and is shown as advances from customers.

- (b) Significant changes in contract assets and liabilities:

Decrease in contract assets (Due from customers under construction contracts) has resulted due to billing in the current year of substantial work carried out in the previous year upon achieving contractual milestones, mainly in respect of sewage treatment projects in the municipal segment.

Decrease in contract assets (Customer retentions) is mainly due to the release of retentions by the customer upon fulfillment of specified conditions in respect of Power generation and evacuation system project.

Decrease in contract liabilities (Amount due to customers under construction contracts) is mainly attributable to wastewater/sewage treatment projects in the industrial/municipal segment, where, out of opening contract liabilities significant revenue has been recognised during the year in accordance with Ind AS 115 Revenue from Contracts with Customers.

Decrease in contract liabilities (Advances from Customers) is due to adjustment of mobilisation advances as a result of progressive/final billings and due to lower advances received against fresh orders.

Notes to the Consolidated Financial Statements

for the year ended March 31, 2021

(All amounts in ₹ lakhs, unless otherwise stated)

- (c) Revenue recognised in relation to contract liabilities:

The following table shows how much of the revenue recognised in the current reporting period relates to carried-forward contract liabilities and how much relates to performance obligations that were satisfied in a prior year.

	Year ended 31-Mar-21	Year ended 31-Mar-20
Revenue recognised that was included in the contract liability balance at the beginning of the period	13313.96	6108.29
Revenue recognised from performance obligations satisfied in previous periods	-	-

NOTE 11: INVENTORIES

	As at 31-Mar-21	As at 31-Mar-20
Raw materials and components	3883.10	2988.14
Less: Provision for obsolescence/slow moving raw materials and components	(114.32)	(129.71)
Work-in-progress	2609.73	3406.72
Finished goods [including stock in transit ₹ 2184.92 lakhs as at 31 March 2021 (31 March 2020: ₹ 686.69 lakhs)]	161840.87	180701.02
Stock in trade	44.89	28.41
Stores and spares [including stock in transit ₹ 0.92 lakhs as at 31 March 2021 (31 March 2020: ₹ 1.49 lakhs)]	5335.85	4389.51
Less: Provision for obsolescence/slow moving stores and spares	(287.53)	(278.14)
Others - Scrap & low value patterns	62.33	106.74
Total inventories	173374.92	191212.69

- (i) The cost of inventories recognised as an expense during the year was ₹ 397845.24 lakhs (31 March 2020: ₹ 373529.45 lakhs)
- (ii) Refer note 20(i) for information on charges created on inventories.
- (iii) The mode of valuation of inventories has been stated in note 1(l).
- (iv) All inventories are expected to be utilised/sold within twelve months except certain items of stores and spares, which are utilised on need basis. Quantum of such stores and spares, which may be utilised beyond one year, is not determinable and is not expected to be material with reference to the total value of inventories.
- (v) For impairment losses recognised during the year refer note 25 & 33.
- (vi) In addition to the cost of inventories recognised as expense as mentioned in (i) above, there are write-downs of inventories to net realisable value amounting to ₹ 31.52 lakhs [31 March 2020: reversal of write-downs of ₹ 143.12 lakhs (net of write-downs of ₹ 226.42 lakhs)] which are also recognised as an expense/income during the year and included in 'Changes in inventories of finished goods, stock-in-trade and work-in-progress' in statement of profit and loss.

Notes to the Consolidated Financial Statements

for the year ended March 31, 2021

(All amounts in ₹ lakhs, unless otherwise stated)

NOTE 12: CASH AND BANK BALANCES

(a) Cash and cash equivalents

	As at 31-Mar-21	As at 31-Mar-20
At amortised cost		
Balances with banks	1063.77	3114.83
Cheques / drafts on hand	40.11	60.93
Cash on hand	23.82	27.85
Total cash and cash equivalents	1127.70	3203.61

(b) Bank balances other than cash and cash equivalents

	As at 31-Mar-21	As at 31-Mar-20
At amortised cost		
Earmarked balances with banks:		
- unpaid dividend and preference share redemption accounts	11.75	5.27
Balances under lien/margin/kept as security:		
- in fixed/margin deposits	58.66	70.58
Other balances:		
- in fixed deposits	61.47	8.62
Total bank balances other than cash and cash equivalents	131.88	84.47

NOTE 13: ASSETS HELD FOR SALE

	As at 31-Mar-21	As at 31-Mar-20
Investments in equity shares (including loan agreed to be converted into equity) of Aqwise Wise Water Technologies Limited (Israel)	660.21	-
Freehold land	-	3.05
Total assets held for sale	660.21	3.05

The activities of Aqwise Wise Water Technologies Ltd. ("Aqwise"), an associate of the Company, based in Israel, has been severely impacted due to the Covid-19 pandemic. The existing shareholders of Aqwise, including the Company, have accordingly agreed to divest their entire equity stake in favour of G.E.S. Global Environmental Solutions Ltd. ("GES") under an agreement dated 25 March 2021. Under the terms of the agreement with GES and understanding arrived at between the existing shareholders of Aqwise:

- (a) loan of USD 2.50 million advanced by the existing shareholders to Aqwise (including USD 2.35 million advanced by the Company), shall be repaid in full along with due interest. Other loans aggregating USD 2.46 million advanced by existing shareholders (including USD 0.4 million advanced by the Company) shall be converted into equity;
- (b) the existing shareholders shall divest their entire shareholding (including those arising from conversion of loan as stated above) in favour of GES. The shares shall be transferred on the Closing Date (as defined in the agreement) upon receipt of necessary approvals and completion of certain other formalities. The consideration for transfer of shares shall be approximately USD 2.4 million (net, after deduction of certain agreed expenses) to be held in an escrow account and which shall be released after the expiry of 18 months ("escrow period"). GES shall, during the escrow period, be entitled to set-off against the escrow amount, any indemnification claim which it may have under the agreement as well as to the extent that it is required to fund Aqwise beyond the amount as specified under the agreement. In case no such set-off adjustments occur, the Company expects to receive approximately USD 1.35 million as its share out of the escrow amount USD 2.4 million.

Notes to the Consolidated Financial Statements

for the year ended March 31, 2021

(All amounts in ₹ lakhs, unless otherwise stated)

- (c) The existing shareholders shall also be entitled to receive certain graded earn-outs, in the nature of contingent receipts, which are subject to Aqwise and/or one of its subsidiary company achieving certain specified financial targets in future periods. The earn-outs receivable, if any, shall not however exceed in the aggregate USD 17.50 million.

Consequent to the aforesaid, the Company shall cease to consolidate the results of the associate company in any subsequent period. The Company has classified its equity investment held in Aqwise (along with the loan which has been agreed to be converted into equity) as "Assets held for sale". No impairment loss was recognised on classification of the investment (including loan) as "Assets held for sale", since the expected consideration of such investment and loan is higher than their carrying amount. Such investment does not form part of any segment assets.

Freehold land above represents carrying value of land situated in Gujarat intended to be disposed of by the Group. The Group had entered into an agreement to sell such land in the previous year and had also received advance of ₹ 10 lakhs (refer note 19) in terms of such agreement to sell. The Group has transferred the title of such land during the current year. The asset does not form part of any segment assets. No impairment loss was recognised on reclassification of the land as held for sale (refer note 4) as the contractual sale price of such land was higher than the carrying amount.

NOTE 14: SHARE CAPITAL

	As at 31-Mar-21		As at 31-Mar-20	
	Number of shares	Amount	Number of shares	Amount
Authorised				
Equity shares of ₹ 1 each	50,00,00,000	5000.00	50,00,00,000	5000.00
Preference shares of ₹ 10 each	2,00,00,000	2000.00	2,00,00,000	2000.00
		7000.00		7000.00
Issued				
Equity shares of ₹ 1 each	24,79,53,110	2479.53	25,79,53,110	2579.53
Subscribed and Paid Up				
Equity shares of ₹ 1 each, fully paid up	24,17,55,110	2417.55	24,79,45,110	2479.45
Add: Paid up value of equity shares of ₹ 1 each forfeited	8,000	0.02	8,000	0.02
		2417.57		2479.47

(i) Movements in equity share capital

	Number of shares	Amount
As at 31 March 2019	25,79,45,110	2579.45
Extinguishment of shares upon buy-back (see (iv) below)	(1,00,00,000)	(100.00)
As at 31 March 2020	24,79,45,110	2479.45
Extinguishment of shares upon buy-back (see (iv) below)	(61,90,000)	(61.90)
As at 31 March 2021	24,17,55,110	2417.55

(ii) Terms and rights attached to equity shares

The Company has only one class of equity shares with a par value of ₹ 1/- per share. The holder of equity shares is entitled to one vote per share. The Company declares and pays dividends in Indian rupees. The dividend proposed by the Board of Directors is subject to the approval of the shareholders in the ensuing Annual General Meeting.

In the event of liquidation of the Company, the holders of equity shares are entitled to receive the remaining assets of the Company, after meeting all liabilities and distribution of all preferential amounts, in proportion to their shareholding.

Notes to the Consolidated Financial Statements

for the year ended March 31, 2021

(All amounts in ₹ lakhs, unless otherwise stated)

(iii) Details of shareholders holding more than 5% shares in the Company

	As at 31-Mar-21		As at 31-Mar-20	
	Number of shares	% holding	Number of shares	% holding
Dhruv M. Sawhney	3,77,33,691	15.61	3,86,50,774	15.59
Rati Sawhney	1,75,10,356	7.24	1,79,35,928	7.23
STFL Trading and Finance Private Limited	7,77,39,178	32.16	7,96,31,128	32.12
Nikhil Sawhney	1,43,67,837	5.94	1,47,17,033	5.94
Tarun Sawhney	1,38,20,236	5.72	1,41,56,123	5.71

(iv) Buy-back of equity shares

During the year, the Company has completed buy-back of 6,190,000 (31 March 2020: 10,000,000) equity shares of ₹ 1/- each [representing 2.5% (31 March 2020: 3.88%) of total pre buy-back paid up equity share capital of the Company] from the shareholders of the Company on a proportionate basis, through the tender offer route under the Securities and Exchange Board of India (Buy-back of Securities), Regulations 2018, at a price of ₹ 105 (31 March 2020: ₹ 100) per equity share for an aggregate amount of ₹ 6499.50 lakhs (31 March 2020: ₹ 10000 lakhs). Accordingly, the Company has extinguished 6,190,000 (31 March 2020: 10,000,000) fully paid up equity shares of ₹ 1 each (in dematerialized form) and the fully paid up equity share capital of the Company (post extinguishment) is 241,755,110 (31 March 2020: 247,945,110) shares of ₹ 1/- each. The Company has funded the buy-back (including transaction costs incurred in relation thereto) from its securities premium. In accordance with section 69 of the Companies Act, 2013, the Company has transferred an amount of ₹ 61.90 lakhs (31 March 2020: ₹ 100 lakhs) to capital redemption reserve which is equal to the nominal value of the shares bought back, as an appropriation from securities premium.

NOTE 15: OTHER EQUITY

	As at 31-Mar-21	As at 31-Mar-20
Capital redemption reserve	635.04	573.14
Capital reserve	2868.83	2706.77
Securities premium	8375.55	16458.13
Amalgamation reserve	926.34	926.34
General reserve	49919.43	49919.43
Molasses storage fund reserve	181.20	140.71
Retained earnings	90205.90	60790.80
Foreign currency translation reserve	25.36	(54.83)
Cash flow hedging reserve	12.18	(73.12)
Total other equity	153149.83	131387.37

(i) Capital redemption reserve

	Year ended 31-Mar-21	Year ended 31-Mar-20
Opening balance	573.14	473.14
Transferred from securities premium on buy-back of equity shares [refer note 14(iv)]	61.90	100.00
Closing balance	635.04	573.14

Notes to the Consolidated Financial Statements

for the year ended March 31, 2021

(All amounts in ₹ lakhs, unless otherwise stated)

Capital redemption reserve upto 31 March 2019 was created consequent to redemption of preference share capital, as required under the provisions of the Companies Act, 1956. Consequent to the buy-back of equity shares, the Group has recognised capital redemption reserve from its securities premium at an amount equal to the nominal amount of equity shares bought back. This reserve shall be utilised in accordance with the provisions of Companies Act, 2013.

(ii) Capital reserve

	Year ended 31-Mar-21	Year ended 31-Mar-20
Opening balance	2706.77	2706.77
Share of associates - adjustments consequent to divestment (refer note 13)	162.06	-
Closing balance	2868.83	2706.77

Capital reserve majorly comprises reserve created consequent to business combination in earlier years, in accordance with the accounting standards then prevailing.

(iii) Securities premium

	Year ended 31-Mar-21	Year ended 31-Mar-20
Opening balance	16458.13	26585.22
Amount utilised for buy-back of equity shares [refer note 14(iv)]	(6437.60)	(9900.00)
Transferred to capital redemption reserve on buy-back of equity shares [refer note 14(iv)]	(61.90)	(100.00)
Transaction costs related to buy-back of equity shares [refer note 14(iv)]	(87.68)	(127.76)
Tax paid on buy-back of equity shares [refer note 14(iv)]	(1456.44)	-
Share of associates - addition	0.01	0.67
Share of associates - adjustments consequent to divestment (refer note 13)	(38.97)	-
Closing balance	8375.55	16458.13

Securities premium is used to record the premium received on issue of shares and is utilised in accordance with the provisions of the Companies Act, 2013. The Group has utilised securities premium for buy-back of its equity shares [refer note 14(iv)].

(iv) Amalgamation reserve

	Year ended 31-Mar-21	Year ended 31-Mar-20
Opening balance	926.34	926.34
Movement during the year	-	-
Closing balance	926.34	926.34

Amalgamation reserve was created consequent to business combinations in past in accordance with the accounting standards then prevailing.

Notes to the Consolidated Financial Statements

for the year ended March 31, 2021

(All amounts in ₹ lakhs, unless otherwise stated)

(v) General reserve

	Year ended 31-Mar-21	Year ended 31-Mar-20
Opening balance	49919.43	49919.43
Movement during the year	-	-
Closing balance	49919.43	49919.43

General reserve represents amount kept by the Group out of its profits for future purposes. It is not earmarked for any specific purpose.

(vi) Molasses storage fund reserve

	Year ended 31-Mar-21	Year ended 31-Mar-20
Opening balance	140.71	216.36
Amount transferred from retained earnings	40.49	21.60
Amount transferred to retained earnings	-	(97.25)
Closing balance	181.20	140.71

Molasses storage fund reserve is created and maintained under the provisions of the Uttar Pradesh Sheera Niyam, 1964 (U.P. Act No. XXIV of 1964) and is to be utilised for the provision and maintenance of adequate storage facilities for molasses. Fixed deposit of ₹ 244.27 lakhs (31 March 2020: ₹ 195.89 lakhs) is earmarked against molasses storage fund (refer note 9).

(vii) Retained earnings

	Year ended 31-Mar-21	Year ended 31-Mar-20
Opening balance	60790.80	30599.11
Net profit for the year	29460.27	33511.82
Other comprehensive income arising from the remeasurement of defined benefit obligation net of income tax	(28.86)	(96.19)
Share of other comprehensive income of associates arising from the remeasurement of defined benefit obligation	24.18	(11.57)
Withdrawn from molasses storage fund reserve	-	97.25
Transfer to molasses storage fund reserve	(40.49)	(21.60)
Dividends paid	-	(2727.40)
Dividend distribution tax	-	(560.62)
Closing balance	90205.90	60790.80

(a) Retained earnings represents undistributed profits of the Group which can be distributed to its equity shareholders in accordance with the provisions of the Companies Act, 2013.

Notes to the Consolidated Financial Statements

for the year ended March 31, 2021

(All amounts in ₹ lakhs, unless otherwise stated)

(b) Details of dividend distributions made and proposed:

	Year ended 31-Mar-21	Year ended 31-Mar-20
Cash dividends on equity shares declared and paid:		
Interim dividend for the year ended 31 March 2021: Nil [31 March 2020: 110% (₹ 1.10 per equity share of ₹ 1/- each)]	-	2727.40
Dividend distribution tax on interim dividend	-	560.62
Total cash dividends on equity shares declared and paid	-	3288.02
Cash dividends on equity shares proposed:		
Final dividend for the year ended 31 March 2021: 175% (₹ 1.75 per equity share of ₹ 1/- each) [31 March 2020: Nil]	4230.71	-

Proposed dividends on equity shares are subject to approval at the annual general meeting and are not recognised as a liability as at 31 March.

(viii) Foreign currency translation reserve

	Year ended 31-Mar-21	Year ended 31-Mar-20
Opening balance	(54.83)	(30.72)
Share of other comprehensive income of associates arising from the exchange differences on translation of foreign operations	(141.36)	(24.11)
Share of associates - adjustments consequent to divestment (refer note 13)	221.55	-
Closing balance	25.36	(54.83)

Exchange differences relating to the translation of the foreign operations are recognised in other comprehensive income and accumulated in the foreign currency translation reserve. The cumulative amount is reclassified to profit or loss when the net investment is disposed of.

(ix) Cash flow hedging reserve

	Year ended 31-Mar-21	Year ended 31-Mar-20
Opening balance	(73.12)	77.36
Share of other comprehensive income of associates arising from effective portion of profit/(loss) on designated portion of hedging instruments in a cash flow hedge	85.30	(150.48)
Closing balance	12.18	(73.12)

The Group uses hedging instruments as a part of its management of foreign currency risk associated with its highly probable forecast sale. For hedging foreign currency risk, the Group uses foreign currency forward contracts which are designated as cash flow hedge. To the extent, these hedge are effective, the changes in fair value of hedging instruments is recognised in the cash flow hedging reserve. Amount recognised in the cash flow hedging reserve is reclassified to profit or loss when hedged item affects profit or loss i.e. sales.

Notes to the Consolidated Financial Statements

for the year ended March 31, 2021
 (All amounts in ₹ lakhs, unless otherwise stated)

NOTE 16: NON-CURRENT BORROWINGS

	As at 31-Mar-21		As at 31-Mar-20	
	Current maturities	Non-current	Current maturities	Non-current
Secured- at amortised cost				
Term loans				
- from banks	4762.59	15332.08	8127.90	22284.07
- from other parties	5910.05	15558.86	6178.82	22075.57
	10672.64	30890.94	14306.72	44359.64
Less: Amount disclosed under the head "Other financial liabilities- current" (refer note 17)	(10672.64)	-	(14306.72)	-
Total non-current borrowings	-	30890.94	-	44359.64

Notes to the Consolidated Financial Statements

for the year ended March 31, 2021

(All amounts in ₹ lakhs, unless otherwise stated)

NOTE 16: NON-CURRENT BORROWINGS (CONTD.) (i) Details of long term borrowings of the Group

	Amount outstanding as at		Interest rate	Number of instalments		Terms of Repayment	Nature of Security
	31-Mar-21	31-Mar-20		31-Mar-21	31-Mar-20		
Secured- at amortised cost							
Term loans from banks (₹ loans)							
1 RBL Bank Limited *	6238.59	7673.59		13	16	Equal quarterly instalments from September 2020 to June 2024	Secured by first pari-passu charge created / to be created by equitable mortgage on immovable assets and hypothecation of all moveable assets, both present and future of the Company and second pari-passu charge on current assets of the Company.
2 Central Bank of India*	4041.13	4978.97		13	16	Equal quarterly instalments from September 2020 to June 2024	Secured by first pari-passu charge created / to be created by equitable mortgage on immovable assets and hypothecation of all moveable assets, both present and future of the Company and second pari-passu charge on current assets of the Company.
3 Punjab National Bank *	4060.59	4996.91	At MCLR plus applicable spread. The interest rate as on 31.03.2021 range between 7.40% to 8.55% per annum.	13	16	Equal quarterly instalments from September 2020 to June 2024	Secured by first pari-passu charge created / to be created by equitable mortgage on immovable assets and hypothecation of all moveable assets, both present and future of the Company and second pari-passu charge on current assets of the Company.
4 Punjab National Bank (Soft Loan)*	-	12485.48		Nil	24	-	Secured by first pari-passu charge created / to be created by equitable mortgage on immovable assets and hypothecation of all moveable assets, both present and future of the Company and second pari-passu charge on current assets of the Company.
5 ICICI Bank Limited	495.00	-		16	-	Equal quarterly instalments from June 2022 to March 2026	Secured by first pari-passu charge created / to be created by equitable mortgage on immovable assets and hypothecation of all moveable assets, both present and future of the Company and second pari-passu charge on current assets of the Company.

Notes to the Consolidated Financial Statements

for the year ended March 31, 2021

(All amounts in ₹ lakhs, unless otherwise stated)

	Amount outstanding as at		Interest rate	Number of instalments		Terms of Repayment	Nature of Security
	31-Mar-21	31-Mar-20		31-Mar-21	31-Mar-20		
6 Axis Bank Limited	5035.10	-	-	48	-	Equal quarterly instalments from December 2021 to September 2033	(i) First charge by way of hypothecation of all the fixed assets / moveable assets and current assets of the borrower subsidiary company (present & future), other than project assets, except those acquired out of free flow of the company in operation phase. (ii) Pledge of 40509000 shares (30% of total equity shares) of the borrower subsidiary company held by the Holding Company. (iii) Unconditional & irrevocable Corporate Guarantee of the Holding Company
7 Axis Bank (Vehicle loan)	200.32	221.72	At fixed rates				
8 PNB Bank (Vehicle loan)	11.81	18.10	ranging from	2 to 51	1 to 56	Equated monthly instalments	Secured by hypothecation of vehicles acquired under the respective vehicle loans.
9 Yes Bank (Vehicle loan)	12.13	37.20	7.60% to 9.99% p.a.				
Total term loans from banks	20094.67	30411.97					
Term loans from other parties (₹ loans)		30411.97					
1 Daimler Financial Services Pvt. Ltd. (Vehicle loan)	95.64	119.71	8.91% p.a.	10	4 to 22	Equated monthly instalments	Secured by hypothecation of vehicles acquired under the respective vehicle loans.
2 Govt. of Uttar Pradesh through RBL Bank Ltd. under SEFASU 2018 *	21373.27	28134.68	5% p.a.	38	51	Equal monthly instalments upto June 2024	Secured by first pari-passu charge on the fixed assets of the Company
Total term loans from other parties	21468.91	28254.39					
Total loans	41563.58	58666.36					

*Loans with interest subvention or below market rate under various schemes of the Government, refer note 43.

Notes to the Consolidated Financial Statements

for the year ended March 31, 2021

(All amounts in ₹ lakhs, unless otherwise stated)

NOTE 17: OTHER FINANCIAL LIABILITIES

	As at 31-Mar-21		As at 31-Mar-20	
	Current	Non-current	Current	Non-current
At amortised cost				
Current maturities of long-term borrowings (refer note 16)	10672.64	-	14306.72	-
Accrued interest	97.86	-	208.80	-
Capital creditors (see (i) below)	1149.76	-	1894.29	-
Employee benefits & other dues payable	3029.02	-	2725.94	-
Lease liabilities	352.85	972.68	544.87	1221.63
Security deposits (see (ii) below)	446.86	-	391.14	-
Unpaid dividends (see (iii) below)	11.73	-	5.25	-
Total other financial liabilities at amortised cost [A]	15760.72	972.68	20077.01	1221.63
At fair value through Profit or Loss (FVTPL) (refer note 42)				
Derivatives financial instruments carried at fair value				
- Foreign exchange forward contracts	-	-	2.19	-
Total other financial liabilities at FVTPL [B]	-	-	2.19	-
Total other financial liabilities ([A]+[B])	15760.72	972.68	20079.20	1221.63

- (i) Capital creditors as at 31 March 2021 include ₹ 24.74 lakhs (31 March 2020 : Nil) outstanding balance of micro enterprises and small enterprises (refer note 49).
- (ii) Security deposits as at 31 March 2021 include ₹ 364 lakhs (31 March 2020 : ₹ 314 lakhs) deposits from sugar selling agents which are interest bearing subject to fulfillment of terms and conditions. These deposits are repayable on cessation of contractual arrangements. Interest payable is normally settled annually.
- (iii) There are no amounts as at the end of the year which are due and outstanding to be credited to the Investors Education and Protection Fund.

NOTE 18: PROVISIONS

	As at 31-Mar-21		As at 31-Mar-20	
	Current	Non-current	Current	Non-current
Provision for employee benefits				
Gratuity (refer note 38)	482.67	4074.09	333.28	3794.78
Compensated absences	543.86	1101.25	509.39	998.56
Other Provisions				
Warranty	2375.07	-	1855.08	-
Cost to completion	220.41	-	385.76	-
Arbitration/Court case claims	105.65	-	99.44	-
Total provisions	3727.66	5175.34	3182.95	4793.34

Notes to the Consolidated Financial Statements

for the year ended March 31, 2021

(All amounts in ₹ lakhs, unless otherwise stated)

(i) Information about individual provisions and significant estimates

(a) Warranty

The Group provides warranties on certain products, undertaking to repair or replace the items that fail to perform satisfactorily during the warranty period. Provisions made represent the amount of expected cost of meeting such obligations of rectifications / replacements based on best estimate considering the historical warranty claim information and any recent trends that may suggest future claims could differ from historical amounts. It also includes provisions made towards contractual obligations to replace certain parts under an Operation and Maintenance contract. The timing of the outflows is expected to be within a period of two years.

(b) Cost to completion

The provision represents costs of materials and services required for integration of water treatment package at the site (the revenue of which has been fully recognised), prior to commissioning.

(c) Arbitration / Court-case Claims

Represents the provision made towards certain claims awarded against the Group in legal proceedings which have been challenged by the Group before appropriate authorities. The timing of the outflows is uncertain.

(ii) Movement in provisions

Movement in each class of provision are set out below:

	Year ended 31-Mar-21			Year ended 31-Mar-20		
	Warranty	Cost to completion	Arbitration/ Court case claims	Warranty	Cost to completion	Arbitration/ Court case claims
Balance at the beginning of the year	1855.08	385.76	99.44	1307.65	1024.47	93.23
Additional provisions recognised	539.25	145.00	6.21	577.53	299.65	6.21
Amounts used during the year	(19.26)	(310.35)	-	(16.84)	(838.36)	-
Unused amounts reversed during the year	-	-	-	(13.26)	(100.00)	-
Balance at the end of the year	2375.07	220.41	105.65	1855.08	385.76	99.44

Notes to the Consolidated Financial Statements

for the year ended March 31, 2021

(All amounts in ₹ lakhs, unless otherwise stated)

NOTE 19: OTHER LIABILITIES

	As at 31-Mar-21		As at 31-Mar-20	
	Current	Non-current	Current	Non-current
Revenue received in advance				
Deferred revenue arising from government grant related to assets (refer note 43)	-	141.46	-	141.45
Deferred revenue arising from government grant related to income (refer note 43)	858.92	821.14	1125.25	1680.07
Amount due to customers under construction contracts [refer note 10(ii)]	6064.42	-	6620.83	-
Other advances				
Advance from customers	5151.28	-	5653.69	-
Advance against assets held for sale (refer note 13)	-	-	10.00	-
Others				
Statutory remittances	2685.68	-	2846.75	-
Miscellaneous other payables	159.31	108.51	251.13	72.11
Total other liabilities	14919.61	1071.11	16507.65	1893.63

NOTE 20: CURRENT BORROWINGS

	As at 31-Mar-21	As at 31-Mar-20
Secured- at amortised cost		
Repayable on demand		
- Cash credits/working capital demand loans/soft loans from banks (see (i) below)	56157.43	94343.87
Unsecured- at amortised cost		
Loans from related parties (refer note 39)	1.09	-
Total current borrowings	56158.52	94343.87

(i) Above loans are secured by pledge/hypothecation of the stock-in-trade, raw material, stores and spare parts, work-in-progress and trade receivables and second charge created/to be created on the properties of all the Engineering units and immovable property at New Delhi and third charge on the properties of Sugar, Co-Generation and Distillery units of the Company on pari-passu basis. Interest rates on the above loans outstanding as at the year end majorly ranges between 4.95% to 8.00% (weighted average interest rate : 5.85% p.a.).

NOTE 21: TRADE PAYABLES

	As at 31-Mar-21	As at 31-Mar-20
Trade payables (at amortised cost)		
- Total outstanding dues of micro enterprises and small enterprises (refer note 49)	538.57	6.73
- Total outstanding dues of creditors other than micro enterprises and small enterprises	61891.35	75635.18
Total trade payables	62429.92	75641.91

Notes to the Consolidated Financial Statements

for the year ended March 31, 2021
 (All amounts in ₹ lakhs, unless otherwise stated)

NOTE 22: INCOME TAX BALANCES

	As at 31-Mar-21		As at 31-Mar-20	
	Current	Non-current	Current	Non-current
Income tax assets				
Tax refund receivable (net)	-	1119.58	-	4391.23
	-	1119.58	-	4391.23
Income tax liabilities				
Provision for income tax (net)	1912.14	-	886.86	-
	1912.14	-	886.86	-

NOTE 23: DEFERRED TAX BALANCES

	As at 31-Mar-21	As at 31-Mar-20
Entities with net deferred tax assets		
Deferred tax assets	27.31	18.15
Deferred tax liabilities	-	-
Net deferred tax assets	27.31	18.15
Entities with net deferred tax liabilities		
Deferred tax assets	3306.42	8319.33
Deferred tax liabilities	(16715.57)	(16142.97)
Net deferred tax liabilities	(13409.15)	(7823.64)

(i) Movement in deferred tax balances

For the year ended 31 March 2021

	Opening balance	Recognised in profit or loss	Recognised in OCI	Closing balance
Tax effect of items constituting deferred tax assets/(liabilities)				
Entities with net deferred tax assets				
Deferred tax assets				
Liabilities and provisions tax deductible only upon payment/actual crystallisation				
- Statutory taxes and duties	18.15	9.16	-	27.31
	18.15	9.16	-	27.31
Deferred tax liabilities	-	-	-	-
Net deferred tax assets	18.15	9.16	-	27.31

Notes to the Consolidated Financial Statements

for the year ended March 31, 2021

(All amounts in ₹ lakhs, unless otherwise stated)

	Opening balance	Recognised in profit or loss	Recognised in OCI	Closing balance
Entities with net deferred tax liabilities				
Deferred tax assets				
Difference in carrying values of investment property	190.86	(24.28)	-	166.58
Liabilities and provisions tax deductible only upon payment/actual crystallisation				
- Employee benefits	1663.90	(124.94)	15.50	1554.46
- Statutory taxes and duties	180.43	(4.00)	-	176.43
- Other contractual provisions	725.42	(37.90)	-	687.52
Impairment provisions of financial assets made in books, but tax deductible only on actual write-off	592.67	91.33	-	684.00
Other temporary differences	40.71	(3.28)	-	37.43
Unutilised tax losses	-	-	-	-
Unused tax credits	4925.34	(4925.34)	-	-
	8319.33	(5028.41)	15.50	3306.42
Deferred tax liabilities				
Difference in carrying values of property, plant & equipment and intangible assets	(13268.36)	(122.60)	-	(13390.96)
Investment in associates under equity method	(2874.61)	(450.00)	-	(3324.61)
	(16142.97)	(572.60)	-	(16715.57)
Net deferred tax liabilities	(7823.64)	(5601.01)	15.50	(13409.15)

For the year ended 31 March 2020

	Opening balance	Recognised in profit or loss	Recognised in OCI	Closing balance
Tax effect of items constituting deferred tax assets/(liabilities)				
Entities with net deferred tax assets				
Deferred tax assets				
Liabilities and provisions tax deductible only upon payment/actual crystallisation				
- Statutory taxes and duties	-	18.15	-	18.15
	-	18.15	-	18.15
Deferred tax liabilities	-	-	-	-
Net deferred tax assets	-	18.15	-	18.15

Notes to the Consolidated Financial Statements

for the year ended March 31, 2021

(All amounts in ₹ lakhs, unless otherwise stated)

	Opening balance	Recognised in profit or loss	Recognised in OCI	Closing balance
Entities with net deferred tax liabilities				
Deferred tax assets				
Difference in carrying values of investment property	278.52	(87.66)	-	190.86
Liabilities and provisions tax deductible only upon payment/actual crystallisation				
- Employee benefits	1955.90	(343.67)	51.67	1663.90
- Statutory taxes and duties	231.39	(50.96)	-	180.43
- Other contractual provisions	863.87	(138.45)	-	725.42
Impairment provisions of financial assets made in books, but tax deductible only on actual write-off	660.93	(68.26)	-	592.67
Other temporary differences	56.77	(16.06)	-	40.71
Unutilised tax losses	0.21	(0.21)	-	-
Unused tax credits	9017.58	(4092.24)	-	4925.34
	13065.17	(4797.51)	51.67	8319.33
Deferred tax liabilities				
Difference in carrying values of property, plant & equipment and intangible assets	(16303.63)	3035.27	-	(13268.36)
Investment in associates under equity method	-	(2874.61)	-	(2874.61)
	(16303.63)	160.66	-	(16142.97)
Net deferred tax liabilities	(3238.46)	(4636.85)	51.67	(7823.64)

Deferred tax charge in the statement of profit and loss for the year ended 31 March 2020 was net of reversal of effect of dividend distribution tax of ₹ 1479.91 lakhs, considered in arriving at Company's share in the undistributed profits of an associate in earlier years.

(ii) Unrecognised deductible temporary differences, unused tax losses and unused tax credits:

Deferred tax assets have not been recognised in respect of following items, because it is not probable that future taxable profit will be available against which the Group can use the benefit therefrom.

	As at 31-Mar-21	As at 31-Mar-20
Tax effect on unused tax losses (long/short term capital losses) (see table below for expiry)	0.41	12.79
Net deferred tax assets/(liabilities)	0.41	12.79
Expiry profile of unrecognised unused tax losses		
Unused tax losses shall expire on -		
(i) Long term capital loss		
March 31, 2021	-	11.77
March 31, 2028	-	0.45
(ii) Short term capital loss		
March 31, 2025	0.16	0.23
March 31, 2026	0.25	0.34
	0.41	12.79

Notes to the Consolidated Financial Statements

for the year ended March 31, 2021

(All amounts in ₹ lakhs, unless otherwise stated)

NOTE 24 : REVENUE FROM OPERATIONS

	Year ended 31-Mar-21	Year ended 31-Mar-20
Sale of products [refer note 37(vii)]		
Finished goods	425887.37	388704.38
Stock-in-trade	2132.59	1859.51
Sale of services		
Erection and commissioning	-	4.66
Servicing	232.18	194.66
Operation and maintenance	2578.00	2978.25
Construction contract revenue	20848.56	26013.05
Other operating revenue		
Subsidy from Central Government (refer note 43)	18579.03	23472.11
Income from sale of renewable energy certificates	16.06	254.00
Income from scrap	61.35	182.60
Total revenue from operations	470335.14	443663.22

(i) Unsatisfied long-term construction contracts:

The transaction price allocated to all contracts (viz. water/wastewater treatment and turnkey projects relating to steam turbine) that are partially or fully unsatisfied as at reporting date alongwith expected period of its revenue recognition, are as follows:

	As at 31-Mar-21 [#]	As at 31-Mar-20 [#]
Within one year	14413.63	28005.22
More than one year	9108.41	19334.00
Total	23522.04	47339.22

[#]As permitted under Ind AS 115, all contracts having original expected duration of one year or less or which are billed based on time incurred are not disclosed.

(ii) Reconciliation of revenue recognised with contract price:

	As at 31-Mar-21	As at 31-Mar-20
Contract price	470481.32	443750.33
Adjustments for Discounts/ Commissions to Customers	(146.18)	(87.11)
Total revenue from operations	470335.14	443663.22

Notes to the Consolidated Financial Statements

for the year ended March 31, 2021

(All amounts in ₹ lakhs, unless otherwise stated)

NOTE 25: OTHER INCOME

	Year ended 31-Mar-21	Year ended 31-Mar-20
Interest income		
Interest income from financial assets carried at amortised cost	249.25	214.43
Interest income from investments carried at FVTPL	0.17	2.60
Interest income from others	321.87	12.73
	571.29	229.76
Dividend income		
Dividend income from equity investments	2.84	2.86
	2.84	2.86
Other non-operating income (net of expenses directly attributable to such income)		
Rental income [refer note 4(ii)]	33.85	45.11
Subsidy from Central Government (refer note 43)	200.64	1224.58
Miscellaneous income	1533.33	1162.31
	1767.82	2432.00
Other gains/(losses)		
Net fair value gains/(losses) on investments	169.36	(61.77)
Net gains/(losses) on derivatives	133.29	(14.16)
Net foreign exchange rate fluctuation gains	-	78.36
Credit balances written back	131.63	208.16
Net profit/(loss) on sale / redemption of investments	0.02	0.10
Net reversal of impairment loss allowance on other non financial assets (31 March 2020 :includes amounts written off ₹ 17.36 lakhs) (refer note 10)	-	16.20
Net reversal of provision for non moving / obsolete inventory (refer note 11)	6.00	74.29
Provision for cost to completion reversed (net) (refer note 18)	165.35	638.71
Excess provision of expenses reversed	92.24	21.91
	697.89	961.80
Total other income	3039.84	3626.42

NOTE 26: COST OF MATERIALS CONSUMED

	Year ended 31-Mar-21	Year ended 31-Mar-20
Stock at the beginning of the year	2988.14	2144.99
Add: Purchases	322396.30	301919.31
Less : Amount capitalised (included in the cost of property, plant and equipment)	(9.52)	(8.34)
Less: Stock at the end of the year	(3883.10)	(2988.14)
Total cost of materials consumed (refer note 43)	321491.82	301067.82

Notes to the Consolidated Financial Statements

for the year ended March 31, 2021

(All amounts in ₹ lakhs, unless otherwise stated)

NOTE 27: PURCHASES OF STOCK-IN-TRADE

	Year ended 31-Mar-21	Year ended 31-Mar-20
Petroleum goods	2174.74	2210.00
Other consumer goods	25.99	19.42
Total purchases of stock-in-trade	2200.73	2229.42

NOTE 28: CHANGES IN INVENTORIES OF FINISHED GOODS, STOCK-IN-TRADE AND WORK-IN-PROGRESS

	Year ended 31-Mar-21	Year ended 31-Mar-20
Inventories at the beginning of the year:		
Finished goods	180701.02	201739.45
Stock in trade	28.41	31.65
Work-in-progress	3406.72	4247.69
Total inventories at the beginning of the year	184136.15	206018.79
Inventories at the end of the year:		
Finished goods	161840.87	180701.02
Stock-in-trade	44.89	28.41
Work-in-progress	2609.73	3406.72
Total inventories at the end of the year	164495.49	184136.15
Add/(Less): Impact of excise duty on finished goods	273.60	-
Total changes in inventories of finished goods, stock-in-trade and work-in-progress	19914.26	21882.64

NOTE 29: EMPLOYEE BENEFITS EXPENSE

	Year ended 31-Mar-21	Year ended 31-Mar-20
Salaries and wages	24173.27	22538.89
Contribution to provident and other funds (refer note 38)	2293.08	2380.77
Staff welfare expenses	640.60	704.57
	27106.95	25624.23
Less: Amount capitalised (included in the cost of property, plant and equipment)	(30.36)	(47.81)
Total employee benefits expense	27076.59	25576.42

Notes to the Consolidated Financial Statements

for the year ended March 31, 2021

(All amounts in ₹ lakhs, unless otherwise stated)

NOTE 30: FINANCE COSTS

	Year ended 31-Mar-21	Year ended 31-Mar-20
Interest costs		
- Interest on loans with interest subvention (refer note 43)	1595.52	1132.33
- Interest on loans with below-market rate of interest (refer note 43)	1348.56	1696.46
- Interest on other borrowings	2002.67	4859.23
- Interest on lease liabilities	147.12	185.93
- Other interest expense	57.65	96.09
Total interest expense on financial liabilities not classified as at FVTPL	5151.52	7970.04
Less : Amount capitalised (included in the cost of property, plant and equipment)	(0.51)	(50.20)
	5151.01	7919.84
Exchange differences regarded as an adjustment to borrowing costs	-	5.17
Other borrowing costs		
- Loan monitoring and administration charges	12.16	8.12
Total finance costs	5163.17	7933.13

NOTE 31: DEPRECIATION AND AMORTISATION EXPENSE

	Year ended 31-Mar-21	Year ended 31-Mar-20
Depreciation of property, plant and equipment (refer note 3)	7860.57	7458.78
Amortisation of intangible assets (refer note 5)	50.28	31.83
	7910.85	7490.61
Less: Amount capitalised (included in the cost of property, plant and equipment)	(2.09)	(1.49)
Total depreciation and amortisation expense	7908.76	7489.12

NOTE 32: IMPAIRMENT LOSS ON FINANCIAL ASSETS (INCLUDING REVERSALS OF IMPAIRMENT LOSSES)

	Year ended 31-Mar-21	Year ended 31-Mar-20
Bad debts written off - trade receivables carried at amortised cost	75.06	315.06
Impairment loss allowance on trade receivables (net of reversals) (refer note 7)	309.65	546.41
Reversal of impairment loss allowance on other financial assets carried at amortised cost (refer note 8 & 9)	(44.53)	-
Total impairment loss on financial assets (including reversal of impairment losses)	340.18	861.47

Notes to the Consolidated Financial Statements

for the year ended March 31, 2021

(All amounts in ₹ lakhs, unless otherwise stated)

NOTE 33: OTHER EXPENSES

	Year ended 31-Mar-21	Year ended 31-Mar-20
Stores and spares consumed	4031.44	3520.40
Power and fuel	2329.25	1575.37
Design and engineering charges	53.32	71.49
Cane development expenses	186.74	164.34
Machining/fabrication expenses	100.81	86.84
Erection and commissioning expenses	999.38	855.68
Civil construction charges	3581.26	4646.37
Packing and stacking expenses	4463.68	4007.31
Repairs and maintenance		
- Machinery	5234.94	4815.68
- Building	823.07	728.34
- Others	378.95	345.37
Factory/operational expenses	2708.66	2648.81
Travelling and conveyance	1104.99	1413.30
Rent expense (refer note 46)	196.34	165.27
Rates and taxes	446.69	464.51
Insurance	698.94	480.77
Directors' fee	69.95	68.65
Directors' commission	96.00	72.50
Legal and professional expenses	1590.98	1032.36
Security service expenses	1654.09	1549.45
Net impairment loss allowance on contract assets (refer note 10)	59.36	24.91
Bad debts written off - other non financial assets (net of reversal of impairment loss allowance of ₹ 0.12 lakhs) (refer note 10)	9.88	-
Net foreign exchange rate fluctuation losses	4.06	-
Warranty expenses [includes provision for warranty (net) ₹ 539.25 lakhs (31 March 2020 : ₹ 564.27 lakhs) (refer note 18)]	540.56	596.44
Provision for Arbitration/Court case claims (refer note 18)	6.21	6.21
Payment to Auditors (see (i) below)	73.93	74.58
Corporate social responsibility expenses (see (ii) below)	427.54	141.20
Loss on sale /write off of inventory	15.77	200.44
Loss on sale / write off / impairment of property, plant and equipment	423.49	19.86
Expenses relating to third party exports under MAEQ scheme	28.75	-
Selling commission	877.75	878.53
Royalty	242.60	269.65
Outward freight and forwarding (refer note 43)	5061.83	4685.85
Other selling expenses	272.93	260.90
Miscellaneous expenses	1812.18	1924.89
Less : Amount capitalised (included in the cost of property, plant and equipment)	(32.97)	(69.11)
Total other expenses	40573.35	37727.16

Notes to the Consolidated Financial Statements

for the year ended March 31, 2021

(All amounts in ₹ lakhs, unless otherwise stated)

(i) Detail of payment to auditors

	Statutory Auditors		Cost Auditors	
	Year ended 31-Mar-21	Year ended 31-Mar-20	Year ended 31-Mar-21	Year ended 31-Mar-20
Audit fee	47.22	47.54	4.48	4.48
Limited review fee	16.20	16.95	-	-
Other services (Certification) *	5.45	1.80	0.33	0.65
Reimbursement of expenses	0.25	2.78	-	0.38
Total payment to auditors	69.12	69.07	4.81	5.51

*This amount is exclusive of ₹ 3 lakhs (31 March 2020: ₹ 3 lakhs) paid to the statutory auditors towards certificates in connection with buy-back of shares. The same has been adjusted against securities premium, as these are transaction costs pertaining to buy-back [refer note 14(iv)].

(ii) Corporate Social Responsibility (CSR)

(a) The Company has incurred CSR expenses mainly towards promoting education and sports, ensuring environmental sustainability and rural development which are specified in Schedule VII of the Companies Act, 2013.

(b) Detail of CSR expenses:

	Year ended 31-Mar-21	Year ended 31-Mar-20
(a) Gross amount required to be spent during the year	427.54	135.32
(b) Maximum amount approved by the Board to be spent during the year	460.85	141.20
(c) Amount spent during the year on :		
(i) Construction/acquisition of any asset	-	-
(ii) Purposes other than (i) above		
Education, Vocational skills and Livelihood enhancement	104.00	71.09
Environmental sustainability and conservation of natural resources	60.00	-
Healthcare	58.43	-
Promoting sports	5.00	5.00
Quality of soil	172.86	53.27
Contribution to Prime Minister National Relief Fund	50.85	-
Rural Development	-	11.84
	451.14	141.20
Less: Excess spent during the year, carried forward to next year	23.60	-
Net amount recognised in the statement of profit and loss	427.54	141.20

Notes to the Consolidated Financial Statements

for the year ended March 31, 2021

(All amounts in ₹ lakhs, unless otherwise stated)

NOTE 34: EXCEPTIONAL ITEMS

	Year ended 31-Mar-21	Year ended 31-Mar-20
Profit on sale of land	66.95	-
Total exceptional items	66.95	-

NOTE 35: INCOME TAX EXPENSE

(i) Income tax recognised in profit or loss

	Year ended 31-Mar-21	Year ended 31-Mar-20
Current tax		
In respect of the current year	10915.06	7920.92
In respect of earlier years	9.33	(10.46)
Total current tax expense	10924.39	7910.46
Deferred tax		
In respect of current year origination and reversal of temporary differences*	5591.85	3138.79
Total deferred tax expense	5591.85	3138.79
Total income tax expense recognised in profit or loss	16516.24	11049.25

* includes utilisation of MAT credit of ₹ 4925.34 lakhs (31 March 2020: ₹ 4092.24 lakhs).

Reconciliation of income tax expense and the accounting profit multiplied by Company's tax rate:

	Year ended 31-Mar-21	Year ended 31-Mar-20
Profit before tax	45976.51	44561.07
Income tax expense calculated at 34.944% (including surcharge and education cess) (2019-20: 34.944%)	16066.03	15571.42
Effect of changes in tax rate [#]	-	(4059.47)
Effect of income that is exempt from taxation	(21.90)	(1.00)
Effect of income that is taxable at lower rates	(46.33)	1.94
Effect of expenses that is non-deductible in determining taxable profit	231.51	176.69
Effect of tax incentives and concessions	(3.79)	(1568.41)
Effect of changes in tax base of assets not considered in profit or loss (net of reversal of temporary differences)	25.63	285.79
Effect of recognition of deferred tax assets/liabilities due to changes in estimates	(206.36)	70.41
Effect of changes in estimates related to prior years	9.71	(10.46)
Effect of different tax rates for subsidiaries	(81.41)	(100.42)
Effect of tax on share in undistributed profit of associates	407.70	682.33
Effect of tax losses for which deferred tax asset not created	0.51	0.43
Effect of elimination of income on consolidation (Net)	134.94	-
Total income tax expense recognised in profit or loss	16516.24	11049.25

[#]With effect from the financial year commencing from 1 April 2019, in accordance with the provisions of section 115BAA of the Income Tax Act, 1961, domestic companies have an option to pay income tax at a concessional rate by foregoing certain existing exemptions, deductions and credits ("new tax regime"). During the year ended 31 March 2020, the Company had assessed the impact of the newly introduced provisions and had decided to continue with the existing tax structure to claim certain deductions and to ensure that the tax credits that it was entitled to were substantially utilized, before opting for the new tax regime. Further, in accordance with the applicable accounting standard, it remeasured its deferred tax liabilities (net) which were expected to reverse in the future when the Company would have shifted to the new tax regime. Accordingly, the charge of deferred tax for the year ended 31 March 2020 was lower by ₹ 4059.47 lakhs. As at 31 March 2021, the Company has not opted to switch to the new tax regime whereas the other group entities, which are subject to tax, have exercised such option.

Notes to the Consolidated Financial Statements

for the year ended March 31, 2021

(All amounts in ₹ lakhs, unless otherwise stated)

During the previous year, with the change in taxation laws relating to taxability of dividend and removal of dividend distribution tax, the Company had provided deferred tax charge of ₹ 1394.70 lakhs in respect of its share in the undistributed profits of its associate, net of reversal of impact of dividend distribution tax considered in arriving at Company's share in the undistributed profits of the said associate in earlier years.

(ii) Income tax recognised in other comprehensive income

	Year ended 31-Mar-21	Year ended 31-Mar-20
Deferred tax related to items recognised in other comprehensive income during the year:		
Remeasurement of defined benefit obligations	(15.50)	(51.67)
Total income tax expense recognised in other comprehensive income	(15.50)	(51.67)
Bifurcation of the income tax recognised in other comprehensive income into:		
Items that will not be reclassified to profit or loss	(15.50)	(51.67)
Items that may be reclassified to profit or loss	-	-
Total income tax expense recognised in other comprehensive income	(15.50)	(51.67)

NOTE 36: EARNINGS PER SHARE

	Year ended 31-Mar-21	Year ended 31-Mar-20
Profit for the year attributable to owners of the Company [A]	29460.27	33511.82
Weighted average number of equity shares for the purposes of basic EPS/ diluted EPS [B]	24,52,99,521	25,16,33,635
Basic earnings per share (face value of ₹ 1 per share) [A/B]	12.01	13.32
Diluted earnings per share (face value of ₹ 1 per share) [A/B]	12.01	13.32

NOTE 37: SEGMENT INFORMATION

(i) Description of segments and principal activities

The operating segments are classified under two major businesses which the Group is engaged in, and are briefly described as under:

Sugar & Allied Business

(a) **Sugar:** The Group is a manufacturer of white crystal sugar, having seven manufacturing plants situated in the states of Uttar Pradesh. The sugar is sold to wholesalers and industrial users. The Group uses its captive produced bagasse, generated as a by-product in the manufacturing of sugar, as a feed stock for generation of power and apart from meeting the power and steam requirements of the associated sugar units, also exports power to the state grid. Molasses, another by-product in the manufacturing of sugar, is used as raw material for producing alcohol/ethanol. The Group sells the surplus molasses and bagasse, after meeting its captive requirements.

(b) **Distillery:** The Group with its two distilleries having total capacity of 320 kilo-litres per day located at Muzaffarnagar, Uttar Pradesh and Sabitgarh, Uttar Pradesh, uses captive molasses produced in manufacture of sugar as the principal raw material in production of various categories of alcohol. The Group has also, under its Alcoholic Beverages vertical forming part of this segment, started producing country liquor during the current year at its bottling facility in the premises of its existing distillery in Muzaffarnagar, Uttar Pradesh, to facilitate forward integration of distillery operations.

Notes to the Consolidated Financial Statements

for the year ended March 31, 2021

(All amounts in ₹ lakhs, unless otherwise stated)

Engineering Business

- (a) **Power transmission:** This business segment is focused on all high speed and niche low speed products - supply of new equipment, after market services and retrofitment of gearboxes, catering to the requirement of power sector as well as other industrial segments. The manufacturing facility is located at Mysore, Karnataka.
- (b) **Water/Wastewater treatment:** The business segment operates from Noida, Uttar Pradesh and provides engineered-to-order process equipment and comprehensive solutions in the water and wastewater management. It operates in EPC segments, HAM projects and O&M. The Group also includes a wholly owned subsidiary "Mathura Wastewater Management Pvt. Ltd." incorporated as a special purpose vehicle to execute a project awarded under Namami Gange Programme.

The 'Other Operations' mainly include selling of own manufactured sugar and trading of jaggery, under the Company's brand name and retailing of diesel/petrol through a Company operated fuel station. It also includes a turnkey project relating to steam turbines which was awarded to it pursuant to bids tendered prior to demerger of steam turbine business.

The above reportable segments have been identified based on the significant components of the enterprise for which discrete financial information is available and are reviewed by the Chief operating decision maker (CODM) to assess the performance and allocate resources to the operating segments. During the current year, the Management had, pursuant to a review, combined the cogeneration operations with the sugar operations in accordance with Ind AS 108 'Operating Segments' as the cogeneration activities no longer qualified as a separate operating segment. Accordingly, the figures of the corresponding previous period(s) have been regrouped. Further, the Board has approved to redesignate the 'Gear business' as the 'Power Transmission business', which is a more accurate representation of the present business, and accordingly, the new terminology has been used in the segment information.

There are no geographical segments as the volume of exports is not significant and the major turnover of the Group takes place indigenously. There is no major reliance on a few customers or suppliers.

Notes to the Consolidated Financial Statements

for the year ended March 31, 2021

(All amounts in ₹ lakhs, unless otherwise stated)

	SUGAR				ENGINEERING				OTHERS		Eliminations		Total				
	Sugar		Distillery		Total Sugar		Power transmission		Water		Total Engineering		Other Operations				
	Year ended 31-Mar-21	Year ended 31-Mar-20	Year ended 31-Mar-21	Year ended 31-Mar-20	Year ended 31-Mar-21	Year ended 31-Mar-20	Year ended 31-Mar-21	Year ended 31-Mar-20	Year ended 31-Mar-21	Year ended 31-Mar-20	Year ended 31-Mar-21	Year ended 31-Mar-20	Year ended 31-Mar-21	Year ended 31-Mar-20	Year ended 31-Mar-21		
REVENUE																	
From external customers	369923.17	350982.86	54350.99	39095.34	424274.16	39079.20	12960.17	15360.28	26074.42	30586.95	39034.59	45947.23	7026.39	7637.79	-	470335.14	443663.22
From inter-segments sales	36388.29	28757.82	24.57	21.31	36412.86	28779.13	47.43	61.86	-	6.50	47.43	68.36	117.82	433.15	(36578.11)	(29280.64)	-
Total revenue from operations	406311.46	379740.68	54375.56	39116.65	460687.02	41857.33	13007.60	15422.14	26074.42	30593.45	39082.02	46015.59	7144.21	8070.94	(36578.11)	(29280.64)	443663.22
RESULT																	
Segment Profit/(loss)	37449.92	35748.57	10105.42	11054.94	47555.34	46803.51	4090.81	4853.53	2674.51	2401.37	6765.32	7254.90	(45.15)	(47.09)			54011.32
Unallocated expenses (Net)																	(3895.11)
Finance cost																	(5163.17)
Interest income																	571.29
Exceptional items																	66.95
Share of profit of associates																	121.04
Profit before tax																	45976.51
Current tax																	(10924.39)
Deferred tax																	(5591.85)
Profit for the year																	29460.27

- The accounting policies of the reportable segments are the same as the Group's accounting policies described in note 1.

- Inter-Segment transfers are priced based on competitive market prices or determined to yield a desired margin or agreed on a negotiated basis.

- Segment profit is the Segment revenue less Segment expenses. Segment revenue/expenses includes all revenues/expenses that are attributable to the segments.

- Dividend income, finance income, finance costs, fair value gains & losses on certain financial assets/liabilities, current tax/deferred tax charge are not allocated to individual segments since these are managed/applicable at an overall Group basis.

Notes to the Consolidated Financial Statements

for the year ended March 31, 2021

(All amounts in ₹ lakhs, unless otherwise stated)

(iii) Segment assets and liabilities

	SUGAR						ENGINEERING						OTHERS		Eliminations		Total	
	Sugar		Distillery		Total Sugar		Power transmission		Water		Total Engineering		Other Operations					
	Year ended 31-Mar-21	Year ended 31-Mar-20	Year ended 31-Mar-21	Year ended 31-Mar-20	Year ended 31-Mar-21	Year ended 31-Mar-20	Year ended 31-Mar-21	Year ended 31-Mar-20	Year ended 31-Mar-21	Year ended 31-Mar-20	Year ended 31-Mar-21	Year ended 31-Mar-20	Year ended 31-Mar-21	Year ended 31-Mar-20	Year ended 31-Mar-21	Year ended 31-Mar-20	Year ended 31-Mar-21	
ASSETS																		
Segment assets	239116.88	285020.87	46060.18	40520.38	285177.06	325541.25	11089.69	38301.55	40011.02	50114.23	51100.71	1148.33	2020.70	-	-	336439.62	378662.66	
Unallocated assets																25555.57	25938.50	
Total assets	239116.88	285020.87	46060.18	40520.38	285177.06	325541.25	11089.69	38301.55	40011.02	50114.23	51100.71	1148.33	2020.70	-	-	361995.19	404601.16	
LIABILITIES																		
Segment liabilities	66154.95	76558.96	2873.31	2305.85	69028.26	78864.81	2436.49	16461.63	21683.13	19655.07	24119.62	573.70	1435.81	-	-	89257.03	104420.24	
Unallocated liabilities																117170.76	166314.08	
Total liabilities	66154.95	76558.96	2873.31	2305.85	69028.26	78864.81	2436.49	16461.63	21683.13	19655.07	24119.62	573.70	1435.81	-	-	206427.79	270734.32	

- The accounting policies of the reportable segments are the same as the Group's accounting policies described in note 1.

- All assets are allocated to reportable segments other than investments, loans, current/deferred tax assets and certain financial assets. Segment assets include all assets that are attributable to the segments.

- All liabilities are allocated to reportable segments other than borrowings, current and deferred tax liabilities and certain financial liabilities. Segment liabilities include all liabilities that are attributable to the segments.

Notes to the Consolidated Financial Statements

for the year ended March 31, 2021

(All amounts in ₹ lakhs, unless otherwise stated)

(iv) Other segment information

	SUGAR				ENGINEERING				OTHERS		Eliminations		Total			
	Sugar		Distillery		Total Sugar		Power transmission		Water		Total Engineering		Other Operations			
	Year ended 31-Mar-20	Year ended 31-Mar-21	Year ended 31-Mar-20	Year ended 31-Mar-21	Year ended 31-Mar-20	Year ended 31-Mar-21	Year ended 31-Mar-20	Year ended 31-Mar-21	Year ended 31-Mar-20	Year ended 31-Mar-21	Year ended 31-Mar-20	Year ended 31-Mar-21	Year ended 31-Mar-20	Year ended 31-Mar-21	Year ended 31-Mar-20	Year ended 31-Mar-21
Amount considered in segment results																
Depreciation and amortisation	4747.89	4615.13	1555.96	1317.93	6303.85	5933.06	811.91	800.07	188.68	191.13	988.75	1003.04	19.71	19.09	-	7312.31
Unallocated depreciation and amortisation																533.93
Total depreciation and amortisation	4747.89	4615.13	1555.96	1317.93	6303.85	5933.06	811.91	800.07	188.68	191.13	988.75	1003.04	19.71	19.09	-	7489.12
Non cash items (other than depreciation and amortisation)	(22.00)	(42.16)	(1.11)	113.89	(23.11)	71.73	191.23	(81.81)	401.25	550.14	319.44	741.37	(0.18)	(0.12)	-	296.15
Unallocated non cash items (other than depreciation and amortisation)																39.14
Total non cash items (other than depreciation and amortisation)	(22.00)	(42.16)	(1.11)	113.89	(23.11)	71.73	191.23	(81.81)	401.25	550.14	319.44	741.37	(0.18)	(0.12)	-	852.12
Amounts not considered in segment results																
Interest expense	4016.78	6810.07	816.29	622.43	4833.07	7432.50	31.33	11.70	967.90	380.10	979.50	411.43	0.66	0.98	-	5813.33
Unallocated interest expense																88.22
Total interest expense	4016.78	6810.07	816.29	622.43	4833.07	7432.50	31.33	11.70	967.90	380.10	979.50	411.43	0.66	0.98	-	7933.13
Interest income	38.33	54.70	8.47	4.36	46.80	59.06	12.14	16.42	218.99	16.56	235.41	28.70	-	-	-	87.76
Unallocated interest income																142.00
Total interest income	38.33	54.70	8.47	4.36	46.80	59.06	12.14	16.42	218.99	16.56	235.41	28.70	-	-	-	229.76
Capital expenditure	4027.22	4182.26	2049.44	4914.10	6076.66	9096.36	307.03	210.47	101.69	195.46	312.16	502.49	0.70	33.30	-	6389.52
Unallocated capital expenditure																199.62
Total Capital expenditure	4027.22	4182.26	2049.44	4914.10	6076.66	9096.36	307.03	210.47	101.69	195.46	312.16	502.49	0.70	33.30	-	11921.96

Notes to the Consolidated Financial Statements

for the year ended March 31, 2021

(All amounts in ₹ lakhs, unless otherwise stated)

(v) Break-up of revenue by geographical area

	Year ended 31-Mar-21	Year ended 31-Mar-20
India (country of domicile)	467293.55	440214.05
Foreign countries	3041.59	3449.17
	470335.14	443663.22

(vi) Non-current assets by geographical area

All non current assets of the Group are located in India.

(vii) Break-up of revenue from major products and services

	Timing of revenue recognition	Year ended 31-Mar-21	Year ended 31-Mar-20
Sale of products			
Finished goods			
- Sugar	At a point in time	346014.17	323525.14
- Molasses	At a point in time	420.88	505.73
- Bagasse	At a point in time	2684.14	3324.20
- Power	At a point in time	6835.05	5415.62
- Alcohol	At a point in time	54102.27	38977.88
- Mechanical equipment - Water/Waste-water	At a point in time	2687.49	1540.60
- Gears/Gear Boxes (including spares)	At a point in time	12634.12	15027.23
- Others	At a point in time	509.25	387.98
		425887.37	388704.38
Stock in trade			
- Petroleum goods (Diesel/Petrol/Lubricants)	At a point in time	2104.33	1841.41
- Other consumer goods	At a point in time	28.26	18.10
		2132.59	1859.51
		428019.96	390563.89
Sale of services			
Erection and commissioning	Over time	-	4.66
Servicing	Over time	232.18	194.66
Operation and maintenance	Over time	2578.00	2978.25
		2810.18	3177.57
Construction contract revenue			
Water, Waste-water and Sewage treatment	Over time	20786.56	25931.56
Power generation and evacuation system	Over time	62.00	81.49
		20848.56	26013.05
Other operating revenue			
Subsidy from Central Government	At a point in time	18579.03	23472.11
Income from sale of renewable energy certificates	At a point in time	16.06	254.00
Income from scrap	At a point in time	61.35	182.60
		18656.44	23908.71

(viii) Information about major customers

There is no single customer who has contributed 10% or more to the Group's revenue in the years ended 31 March 2021 and 31 March 2020.

Notes to the Consolidated Financial Statements

for the year ended March 31, 2021

(All amounts in ₹ lakhs, unless otherwise stated)

NOTE 38: EMPLOYEE BENEFIT PLANS

(i) Defined contribution plans

- (a) The Group contributes to certain defined contribution retirement benefit plans under which the Group pays fixed contributions to separate entities (funds) or financial institutions or state managed benefit schemes. The Group has no further payment obligations once the contributions have been paid. Following are the schemes covered under defined contributions plans of the Group:

Provident Fund Plan & Employee Pension Scheme: The Group makes monthly contributions at prescribed rates towards Employee Provident Fund/ Employee Pension Scheme administered and managed by the Government of India.

Employee State Insurance: The Group makes prescribed monthly contributions towards Employees State Insurance Scheme.

Superannuation Scheme: The Group contributes towards a fund established to provide superannuation benefit to certain employees in terms of Group Superannuation Policies entered into by such fund with the Life Insurance Corporation of India.

National Pension Scheme: The Group makes contributions to the National Pension Scheme fund in respect of certain employees of the Group.

- (b) The expense recognised during the period towards defined contribution plans are as follows:

	Year ended 31-Mar-21	Year ended 31-Mar-20
Employers' contribution to Employees' Provident Fund *1	1293.48	1231.29
Administration and other expenses relating to above *2	40.32	31.41
Employers' contribution to Employees' State Insurance Scheme	7.54	8.80
Employers' contribution to Superannuation Scheme	124.96	127.50
Employers' contribution to National Pension Scheme	50.77	43.56

*1 Contribution for the financial year ended 31 March 2020 includes contribution of ₹ 179.27 lakhs made till October 2019 to a Provident Fund Trust set up by the company for managing the obligations of a specific establishment which had been granted exemption from contributing directly to the Regional Provident Fund Commissioner. The Company requested surrender of the exemption during the financial year ended 31 March 2020 and accordingly, the contributions w.e.f. 1 November 2019 (i.e., contributions in respect of salary payable for the month of October 2019 onwards) has been deposited directly with the provident fund authority and past accumulations of all the members also stand transferred to such authority. The employer's contribution for the financial year ended 31 March 2020, as depicted in the table above, also includes an amount of ₹ 189.50 lakhs towards funding by the Company of the deficit of the Trust in transferring such past accumulations.

*2 Administrative and other expenses payable to the Provident Fund authorities in respect of the financial year ended 31 March 2020 includes ₹ 4.19 lakhs pertaining to the Provident Fund Trust set up by the company as mentioned in * 1 above.

(ii) Defined benefit plan (Gratuity)

- (a) The Group operates a defined benefit retirement plan under which the Group pays certain defined benefit by way of gratuity to its employees. The Gratuity Plan provides a lump sum payment to vested employees at retirement/ termination of employment or upon death of an employee, based on the respective employees' salary and years of employment with the Group.

Notes to the Consolidated Financial Statements

for the year ended March 31, 2021

(All amounts in ₹ lakhs, unless otherwise stated)

(b) Risk exposure

The plan typically exposes the Group to number of actuarial risks, the most significant of which are detailed below:

Investment risk: The plan liabilities are calculated using a discount rate set with references to government bond yields as at end of reporting period; if plan assets under perform compared to the government bonds discount rate, this will create or increase a deficit. The investments in plan assets are made in accordance with pattern of investment prescribed by central government and ensures that the funds are invested in a balanced mix of investments comprising central government securities, state government securities, other debt instruments as well as equity instruments. Most of the plan investments is in fixed income securities with high grades and in government securities. The Group has a risk management strategy which defines exposure limits and acceptable credit risk rating.

Interest risk: A decrease in government bond yields will increase plan liabilities, although this is expected to be partially offset by an increase in the value of the plan's debt instruments.

Life expectancy: The present value of the defined benefit plan liability is calculated by reference to the best estimate of the mortality of plan participants during their employment. A change in the life expectancy of the plan participants will impact the plan's liability.

Salary risk: The present value of the defined benefit plan liability is calculated by reference to the future salaries of plan participants. As such, an increase in the salary of the plan participants will increase the plan's liability.

Attrition rate: The present value of the defined benefit plan liability is impacted by the rate of employee turnover, disability and early retirement of plan participants. A change in the attrition rate of the plan participants will impact the plan's liability.

(c) The significant actuarial assumptions used for the purposes of the actuarial valuations were as follows:

	Valuation as at	
	31-Mar-21	31-Mar-20
Discounting rate	6.50%	6.60%
Future salary growth rate	5.50% for next year and 8% thereafter	5.50% for next 2 years and 8% thereafter
Mortality table*	IALM 2012-14 Ultimate	IALM 2012-14 Ultimate
Attrition rate	7.00% for Permanent employees 4.00% for Seasonal employees	7.00% for Permanent employees 3.00% for Seasonal employees
Method used	Projected unit credit method	Projected unit credit method

*Assumptions regarding future mortality are set based on actuarial advice in accordance with published statistics (i.e. IALM 2012-14 Ultimate). These assumptions translate into an average life expectancy in years at retirement age.

Notes to the Consolidated Financial Statements

for the year ended March 31, 2021

(All amounts in ₹ lakhs, unless otherwise stated)

- (d) Amounts recognised in statement of profit and loss in respect of the defined benefit plan (gratuity) are as follows:

	Year ended 31-Mar-21	Year ended 31-Mar-20
Current service cost	438.48	408.39
Net interest expense	246.77	255.66
Components of defined benefit costs recognised in profit or loss	685.25	664.05
Remeasurement on the net defined benefit liability		
- Return on plan assets (excluding amount included in net interest expense)	(49.22)	66.50
- Actuarial gains and loss arising from changes in demographic assumptions	(7.54)	0.75
- Actuarial gains and loss arising from changes in financial assumptions	36.64	88.07
- Actuarial gains and loss arising from experience adjustments	64.48	(7.46)
Components of defined benefit costs recognised in other comprehensive income	44.36	147.86
Total	729.61	811.91

- (e) Amounts included in the balance sheet arising from the entity's obligation in respect of the defined benefit plan (gratuity) is as follows:

	As at 31-Mar-21	As at 31-Mar-20
Present value of defined benefit obligation as at the end of the year	6310.39	5727.01
Fair value of plan assets	1753.63	1598.95
Funded status	(4556.76)	(4128.06)
Net asset/(liability) arising from defined benefit obligation recognised in the balance sheet	(4556.76)	(4128.06)

- (f) Movement in the present value of the defined benefit obligation (gratuity) is as follows:

	Year ended 31-Mar-21	Year ended 31-Mar-20
Present value of defined benefit obligation at the beginning of the year	5727.01	5294.33
Expenses recognised in profit or loss		
- Current service cost	438.48	408.39
- Interest expense (income)	352.23	372.81
Remeasurement (gains)/losses recognised in other comprehensive income		
- Actuarial (gain)/loss arising from:		
i. Demographic assumptions	(7.54)	0.75
ii. Financial assumptions	36.64	88.07
iii. Experience adjustments	64.48	(7.46)
Benefit payments	(300.91)	(429.88)
Present value of defined benefit obligation at the end of the year	6310.39	5727.01

Notes to the Consolidated Financial Statements

for the year ended March 31, 2021

(All amounts in ₹ lakhs, unless otherwise stated)

(g) Movement in the fair value of the plan assets (gratuity) is as follows:

	Year ended 31-Mar-21	Year ended 31-Mar-20
Fair value of plan assets at the beginning of the year	1598.95	1548.30
Recognised in profit or loss		
- Expected return on plan assets	105.46	117.15
Remeasurement gains / (losses) recognised in other comprehensive income		
- Actual return on plan assets in excess of the expected return	49.22	(66.50)
Contributions by employer	300.91	429.88
Benefit payments	(300.91)	(429.88)
Fair value of plan assets at the end of the year	1753.63	1598.95

The fair value of the plan assets (gratuity) at the end of the reporting period for each category, are as follows:

	As at 31-Mar-21			As at 31-Mar-20		
	Quoted	Unquoted	Total	Quoted	Unquoted	Total
Cash and cash equivalents	-	42.10	42.10	-	17.58	17.58
Debt instruments						
- Government securities	-	266.94	266.94	-	265.60	265.60
- State development loans	-	702.47	702.47	-	563.19	563.19
- Private sector bonds	-	48.00	48.00	-	45.34	45.34
- Public sector bonds	-	309.71	309.71	-	170.85	170.85
- Fixed deposits with banks	-	47.50	47.50	-	142.50	142.50
- Special deposit scheme balance with RBI	-	102.13	102.13	-	102.13	102.13
- Debt mutual funds	-	78.72	78.72	-	74.96	74.96
Equity instruments						
- Index mutual funds	-	90.73	90.73	-	39.76	39.76
- Arbitrage mutual funds	-	14.91	14.91	-	14.34	14.34
Accrued interest and other recoverables	-	50.42	50.42	-	162.70	162.70
Total plan assets	-	1753.63	1753.63	-	1598.95	1598.95

The investible funds of the Gratuity Plan are invested in accordance with the investment pattern and norms prescribed by the Ministry of Finance, Government of India. The investment pattern mandates that the investible funds are invested across the permitted investments in the prescribed pattern, whereby the investment risk is spread across various categories of investment comprising sovereign government securities, state development loans monitored by the Reserve Bank of India, investment grade rated debt securities issued by private and public sector companies, fixed-deposit with banks fulfilling the prescribed norms, units of debt and equity mutual funds. The investments made are generally on held-to-maturity basis. It is the endeavour of the Group to mitigate risk by investing only in high-quality debt securities and in mutual funds after undertaking due diligence. There has been no change in the process used by the Group to manage its risks from prior periods.

Notes to the Consolidated Financial Statements

for the year ended March 31, 2021

(All amounts in ₹ lakhs, unless otherwise stated)

(h) Sensitivity analysis

The sensitivity of the defined benefit obligation (gratuity) to changes in the weighted principal assumptions is:

	Change in assumption by	Increase/decrease	Impact on defined benefit obligation (gratuity)			
			Increase in assumption		Decrease in assumption	
			31-Mar-21	31-Mar-20	31-Mar-21	31-Mar-20
Discounting rate	0.50%	in ₹ lakhs	(176.27)	(167.32)	186.74	177.44
		in %	-2.79%	-2.92%	2.96%	3.10%
Future salary growth rate	0.50%	in ₹ lakhs	183.85	175.35	(175.29)	(167.01)
		in %	2.91%	3.06%	-2.78%	-2.92%
Attrition rate	0.50%	in ₹ lakhs	(15.16)	(13.04)	15.84	13.66
		in %	-0.24%	-0.23%	0.25%	0.24%
Mortality rate	10.00%	in ₹ lakhs	(1.06)	(0.90)	1.06	0.90
		in %	-0.02%	-0.02%	0.02%	0.02%

The above sensitivity analysis are based on a change in an assumption while holding all other assumptions constant. In practice, it is unlikely to occur, and changes in some of the assumptions may be correlated. The methods and types of assumptions used in preparing the sensitivity analysis did not change compared to prior period.

(i) Defined benefit liability (gratuity) and employer contributions

The Group remains committed to fund all gratuity payments falling due and shall strive to gradually reduce the deficit in funding of its obligation in the coming years.

The Group expects to contribute ₹ 1016.94 lakhs to the defined benefit plan relating to gratuity during the next financial year.

The weighted average duration of the defined gratuity obligation (on discounted cash flow basis) as at 31 March 2021 is 6 years (31 March 2020: 6 years).

The expected maturity analysis of undiscounted defined benefit obligation (gratuity) as at 31 March 2021 is as follows:

	Less than a year	Between 1-2 years	Between 3-5 years	Over 5 years	Total
Defined benefit obligation (Gratuity)	1473.53	763.33	1864.53	5839.76	9941.15

- (iii) The President has given his assent to The Code on Social Security, 2020 ('Code') in respect of employee benefits (during employment and post-employment) in September 2020. The Code may impact the contributions made by the Group towards Provident Fund and Gratuity. However, the date on which the Code will come into effect has not yet been notified. The Group would assess and give effect to the implications, if any, arising from the implementation of the Code, in the period in which, the Code becomes effective and the related rules are notified.

Notes to the Consolidated Financial Statements

for the year ended March 31, 2021

(All amounts in ₹ lakhs, unless otherwise stated)

NOTE 39: RELATED PARTY TRANSACTIONS

(i) Subsidiaries (wholly owned) - incorporated under section 8 of the Companies Act, 2013

Triveni Foundation (incorporated on 28 June 2020)

(ii) Related parties with whom transactions have taken place during the year alongwith details of such transactions and outstanding balances as at the end of the year:

Name of related party and nature of transactions	Relationship	Year ended 31-Mar-21	Year ended 31-Mar-20
Sales and rendering services			
Triveni Turbine Limited	Associate	2877.84	3539.25
Purchases and receiving services			
Triveni Turbine Limited	Associate	222.85	293.61
Tirath Ram Shah Charitable Trust	Enterprise over which key managerial personnel have substantial interest/ significant influence	-	0.91
Interest income			
Aqwise Wise Water Technologies Limited (Israel)	Associate	127.48	9.50
Rent & other charges received			
Triveni Turbine Limited	Associate	19.82	21.81
Dividend received from investment in equity shares			
Triveni Turbine Limited	Associate	-	353.14
Rent paid			
Dhruv M. Sawhney (Chairman & Managing Director) *	Key managerial personnel	59.37	53.97
Rati Sawhney	Relative of key managerial personnel	38.77	36.82
Kameni Upaskar Limited	Enterprise over which key managerial personnel have substantial interest/ significant influence	93.55	84.88
Corporate Social Responsibility expenses			
Tirath Ram Shah Charitable Trust	Enterprise over which key managerial personnel have substantial interest/ significant influence	83.21	-
Triveni Foundation	Subsidiary incorporated u/s 8 of the Companies Act, 2013	65.00	-
Remuneration			
Tarun Sawhney (Vice Chairman & Managing Director)	Key managerial personnel	650.39	556.27

Notes to the Consolidated Financial Statements

for the year ended March 31, 2021

(All amounts in ₹ lakhs, unless otherwise stated)

Name of related party and nature of transactions	Relationship	Year ended 31-Mar-21	Year ended 31-Mar-20
Suresh Taneja (Group Chief Financial Officer)	Key managerial personnel	233.38	226.16
Geeta Bhalla (Group Vice President & Company Secretary)	Key managerial personnel	95.60	87.17
Directors fee paid			
Nikhil Sawhney (Promoter Non-Executive Director)	Key managerial personnel	9.60	11.40
Lt. Gen (Retd.) Kanwal Kishan Hazari (Independent Non-Executive Director)	Key managerial personnel	-	8.20
Shekhar Dutta (Independent Non-Executive Director)	Key managerial personnel	14.75	11.25
Homai A. Daruwalla (Independent Non-Executive Director)	Key managerial personnel	15.00	10.50
Dr. Santosh Pande (Independent Non-Executive Director)	Key managerial personnel	10.60	10.80
Sudipto Sarkar (Independent Non-Executive Director)	Key managerial personnel	12.00	9.50
J. K. Dadoo (Independent Non-Executive Director)	Key managerial personnel	8.00	7.00
Directors commission			
Nikhil Sawhney (Promoter Non-Executive Director)	Key managerial personnel	45.00	30.00
Shekhar Dutta (Independent Non-Executive Director)	Key managerial personnel	10.00	8.50
Homai A. Daruwalla (Independent Non-Executive Director)	Key managerial personnel	11.00	8.50
Dr. Santosh Pande (Independent Non-Executive Director)	Key managerial personnel	10.00	8.50
Sudipto Sarkar (Independent Non-Executive Director)	Key managerial personnel	10.00	8.50
J. K. Dadoo (Independent Non-Executive Director)	Key managerial personnel	10.00	8.50
Contribution to post employment benefit plans			
Triveni Engineering Works Limited Gratuity Fund	Post employment benefit plan	300.91	428.04
Triveni Engineering and Industries Limited Officers Pension Scheme	Post employment benefit plan	124.96	127.50
Upper India Sugar Mills Employees' Provident Fund	Post employment benefit plan	-	529.59
Contribution towards deficiency in provident fund trust			
Upper India Sugar Mills Employees' Provident Fund	Post employment benefit plan	-	189.50

Notes to the Consolidated Financial Statements

for the year ended March 31, 2021

(All amounts in ₹ lakhs, unless otherwise stated)

Name of related party and nature of transactions	Relationship	Year ended 31-Mar-21	Year ended 31-Mar-20
Expenses incurred by the Group on behalf of party (net of expenses incurred by party on behalf of the Group) on reimbursable basis			
Triveni Turbine Limited	Associate	1.49	23.91
Kameni Upaskar Limited	Enterprise over which key managerial personnel have substantial interest/significant influence	(3.76)	(2.82)
Triveni Engineering Works Limited Gratuity Fund	Post employment benefit plan	(0.02)	(0.02)
Triveni Engineering and Industries Limited Officers Pension Scheme	Post employment benefit plan	(0.00)	(0.00)
Triveni Engineering Works Limited Employees' Provident Fund	Post employment benefit plan	-	(0.00)
Upper India Sugar Mills Employees' Provident Fund	Post employment benefit plan	-	(0.19)
Dividend paid on equity shares			
Dhruv M. Sawhney (Chairman & Managing Director) *	Key managerial personnel	-	425.16
Tarun Sawhney (Vice Chairman & Managing Director)	Key managerial personnel	-	155.72
Nikhil Sawhney (Promoter Non-Executive Director)	Key managerial personnel	-	161.89
Suresh Taneja (Group Chief Financial Officer)	Key managerial personnel	-	0.15
Shekhar Dutta (Independent Non-Executive Director)	Key managerial personnel	-	0.11
Manmohan Sawhney HUF	Relative of key managerial personnel	-	47.82
Rati Sawhney	Relative of key managerial personnel	-	197.30
Tarana Sawhney	Relative of key managerial personnel	-	0.26
STFL Trading and Finance Private Limited *	Enterprise over which key managerial personnel have substantial interest/significant influence	-	875.94
Buy-back of equity shares			
Dhruv M. Sawhney (Chairman & Managing Director) *	Key managerial personnel	962.94	1479.98
Tarun Sawhney (Vice Chairman & Managing Director)	Key managerial personnel	352.68	539.25
Nikhil Sawhney (Promoter Non-Executive Director)	Key managerial personnel	366.66	560.62

Notes to the Consolidated Financial Statements

for the year ended March 31, 2021

(All amounts in ₹ lakhs, unless otherwise stated)

Name of related party and nature of transactions	Relationship	Year ended 31-Mar-21	Year ended 31-Mar-20
Suresh Taneja (Group Chief Financial Officer)	Key managerial personnel	0.35	0.54
Manmohan Sawhney HUF	Relative of key managerial personnel	108.31	165.62
Rati Sawhney	Relative of key managerial personnel	446.85	683.24
Tarana Sawhney	Relative of key managerial personnel	0.60	0.92
STFL Trading and Finance Private Limited *	Enterprise over which key managerial personnel have substantial interest/ significant influence	1986.55	3064.93
Sale of property, plant & equipment			
Tirath Ram Shah Charitable Trust	Enterprise over which key managerial personnel have substantial interest/ significant influence	1.05	1.29
Investment made in equity shares			
Triveni Foundation	Subsidiary incorporated u/s 8 of the Companies Act, 2013	1.00	-
Acquisition of equity shares of United Shippers & Dredgers Limited			
Subhadra Trade and Finance Limited	Enterprise over which key managerial personnel have substantial interest/ significant influence	23.00	-
Advance paid against purchase of bonds			
Upper India Sugar Mills Employees' Provident Fund	Post employment benefit plan	-	160.00
Purchase of investment in bonds			
Upper India Sugar Mills Employees' Provident Fund	Post employment benefit plan	165.27	-
Loans given (including interest converted to loan)			
Aqwise Wise Water Technologies Limited (Israel)	Associate	1875.05	-

Related party transactions stated above are inclusive of applicable taxes

Notes to the Consolidated Financial Statements

for the year ended March 31, 2021

(All amounts in ₹ lakhs, unless otherwise stated)

Outstanding balances

Name of related party and nature of balances	Relationship	As at 31-Mar-21	As at 31-Mar-20
Receivable			
Triveni Turbine Limited	Associate	380.12	271.68
Aqwise Wise Water Technologies Limited (Israel)	Associate	1831.47	305.50
Upper India Sugar Mills Employees' Provident Fund	Post employment benefit plan	-	160.00
Tirath Ram Shah Charitable Trust	Enterprise over which key managerial personnel have substantial interest/ significant influence	1.05	-
Payable			
Triveni Turbine Limited	Associate	501.76	1374.78
Dhruv M. Sawhney (Chairman & Managing Director) *	Key managerial personnel	3.27	4.11
Tarun Sawhney (Vice Chairman & Managing Director)	Key managerial personnel	253.20	153.65
Suresh Taneja (Group Chief Financial Officer)	Key managerial personnel	0.20	0.13
Nikhil Sawhney (Promoter Non-Executive Director)	Key managerial personnel	45.46	30.00
Shekhar Dutta (Independent Non-Executive Director)	Key managerial personnel	10.00	8.50
Homai A. Daruwalla (Independent Non-Executive Director)	Key managerial personnel	11.46	8.50
Dr. Santosh Pande (Independent Non-Executive Director)	Key managerial personnel	10.46	8.50
Sudipto Sarkar (Independent Non-Executive Director)	Key managerial personnel	10.00	8.50
J. K. Dadoo (Independent Non-Executive Director)	Key managerial personnel	10.00	8.50
Tirath Ram Shah Charitable Trust	Enterprise over which key managerial personnel have substantial interest/ significant influence	-	1.02
Subhadra Trade and Finance Limited	Enterprise over which key managerial personnel have substantial interest/ significant influence	1.09	-
Triveni Engineering and Industries Limited Officers Pension Scheme	Post employment benefit plan	124.96	127.50
Upper India Sugar Mills Employees' Provident Fund	Post employment benefit plan	-	189.69

* Person or entity belonging to the promoter/promoter group holding 10% or more shareholding in the Company

Notes to the Consolidated Financial Statements

for the year ended March 31, 2021

(All amounts in ₹ lakhs, unless otherwise stated)

(iii) Remuneration of key managerial personnel:

	Year ended 31-Mar-21	Year ended 31-Mar-20
Short-term employee benefits	914.84	805.88
Post-employment benefits	64.53	63.72
Total	979.37	869.60

The remuneration of key managerial personnel is determined by the remuneration committee having regard to the performance of individuals, market trends and applicable provisions of Companies Act, 2013.

(iv) Remuneration and outstanding balances of key managerial personnel does not include long term employee benefits by way of gratuity and compensated absences, which are currently not payable and are provided on the basis of actuarial valuation by the Company.

(v) Terms & conditions:

- (a) Transactions relating to dividends, buyback of shares were on same terms and conditions that applied to other shareholders.
- (b) Loans to associate are given at normal commercial terms & conditions at prevailing market rate of interest.
- (c) Sales to and purchases from related parties, including rendering/availment of service, are made on terms equivalent to those that prevail in arm's length transactions. All other transactions were made on normal commercial terms and conditions and at market rates.
- (d) The outstanding balances at the year-end are unsecured and settlement occurs in cash.

NOTE 40: CAPITAL MANAGEMENT

For the purpose of capital management, capital includes net debt and total equity of the Group. The primary objective of the capital management is to maximize shareholder value along with an objective to keep the leverage in check in view of cyclical capital intensive sugar business of the Group.

One of the major businesses of the Group is the sugar business, a seasonal industry, where the entire production occurs in about five to six months which is sold throughout the year. Thus, it necessitates keeping high levels of sugar inventory requiring high working capital funding. Sugar business being also a cyclical business, it is prudent to avoid high leverage and the resultant high finance cost. It is the endeavour of the Group to prune down debts to acceptable levels based on its financial position.

The Group may resort to further issue of capital when the funds are required to make the Group stronger financially or to invest in projects meeting the ROI expectations of the Group.

Notes to the Consolidated Financial Statements

for the year ended March 31, 2021

(All amounts in ₹ lakhs, unless otherwise stated)

The Group monitors capital structure through gearing ratio represented by debt-equity ratio (debt/total equity). In addition to the gearing ratio, the Group also looks at long term debt to operating profit ratio (long term debt/EBITDA) which gives an indication of adequacy of earnings to service the debts. The Group carefully negotiates the terms and conditions of the loans and ensures adherence to all the financial covenants. With a view to arrive at the desired capital structure based on the financial condition of the Group, the Group normally incorporates a clause in loan agreements for prepayment of loans without any premium. The gearing ratios and long term debt/EBITDA ratio for the Group as at the end of reporting period were as follows:

	As at 31-Mar-21	As at 31-Mar-20
Non-current borrowings (note 16)	30890.94	44359.64
Current borrowings (note 20)	56158.52	94343.87
Current maturities of long-term borrowings (note 17)	10672.64	14306.72
Total debt	97722.10	153010.23
Add: Deferred revenue arising from government grant related to borrowings (refer note 19)	1680.06	2805.32
Less: Cash and cash equivalents [note 12(a)]	(1127.70)	(3203.61)
Net debt	98274.46	152611.94
Total equity (note 14 & note 15)	155567.40	133866.84
EBITDA (before exceptional items)	58981.49	59983.32
Net debt to equity ratio	0.63	1.14
Long term debt equity ratio	0.28	0.46
Long term debt/EBITDA ratio	0.73	1.02

No changes were made in the objectives, policies or process for managing capital during the years ended 31 March 2021 and 31 March 2020.

The Group is not subject to any externally imposed capital requirements.

NOTE 41: FINANCIAL RISK MANAGEMENT

The Group's principal financial liabilities comprise loans and borrowings, trade payables and other payables. The main purpose of the financial liabilities is to finance the Group's operations. The Group's principal financial assets include loans, trade and other receivables and cash and bank balances that derive directly from its operations. The Group also holds investments measured at fair value through profit or loss and enters into derivative transactions, which are not extensive.

The Group's activities expose it mainly to market risk, liquidity risk and credit risk. The monitoring and management of such risks is undertaken by the senior management of the Group and there are appropriate policies and procedures in place through which such financial risks are identified, measured and managed in accordance with the Group's policies and risk objectives. The Group has specialised teams to undertake derivative activities for risk management purposes and such team has appropriate skills, experience and expertise. It is the Group policy not to carry out any trading in derivative for speculative purposes. The Audit Committee and the Board are regularly apprised of these risks every quarter and each such risk and mitigation measures are extensively discussed.

(i) Credit risk

Credit risk is associated with the possibility of a counterparty defaulting on its contractual obligations to pay, resulting in financial loss to the Company. The Group is exposed to credit risks from its operating activities, primarily trade receivables. The credit risks in respect of deposits with the banks, foreign exchange transactions and other financial instruments are nominal. As required, the Group also advances loans to its associate company and there is some credit risk associated with it. As far as practicable, the Group endeavours to take reasonable security to mitigate the credit risk.

Notes to the Consolidated Financial Statements

for the year ended March 31, 2021

(All amounts in ₹ lakhs, unless otherwise stated)

(a) Credit risk management

The customer credit risk is managed by each business subject to the Group's established policy, procedure and controls relating to customer credit risk management. Various businesses require different processes and policies to be followed based on the business risks, industry practice and customer profiles.

In the case of Sugar business, majority of the sales are made either against advance payments or on very short credit period upto 7-10 days through established sugar agents whereas in Cogeneration, forming part of sugar business, and Distillery, most of the sales are made to Government customers, such as, State Electricity Board (UPPCL) and Oil Marketing Companies (OMCs). There may be delays, generally not exceeding one year, in receiving payments from UPPCL but the risk in respect of realisation of dues is minimal. In Power transmission business, it is the policy of the Group to receive payment prior to delivery of the material except in the case of some well established OEMs, including public sector undertakings, where the credit up to 90 days is extended. Water business is engaged in Engineering, Procurement and Construction (EPC) business in the municipal and industrial sectors where it is customary to have prescribed retentions which are payable upon completion of the project and after satisfactory performance of the plant.

In order to contain the business risk, creditworthiness of the customer is ensured through scrutiny of its financials, status of financial closure of the project, if required, market reports and reference checks. The Group remains vigilant and regularly assesses the financial position of customers during execution of contracts with a view to restrict risks of delays and default. In view of its diversified business profile and considering the size of the Group, credit risks from receivables are well contained on an overall basis.

The impairment analysis is performed on each reporting period on individual basis for major customers. In addition, a large number of receivables are grouped and assessed for impairment collectively. The calculation of impairment loss is based on historical data of losses, current conditions and forecasts and future economic conditions. The Group's maximum exposure to credit risk at the reporting date is the carrying amount of each financial asset as detailed in note 6, 7, 8, 9 and 12.

The business wise receivable position as at the end of the year is provided here below:

	Year ended 31-Mar-21			Year ended 31-Mar-20		
	External sales (A)	Year end receivables (B)	% Receivables (B/A)	External sales (A)	Year end receivables (B)	% Receivables (B/A)
Sugar business	351399.03	5726.64	2%	327598.42	9315.82	3%
Distillery business	54350.99	3206.57	6%	39095.34	3261.83	8%
Power transmission business	12909.37	4248.02	33%	15272.61	2661.87	17%
Water business	26070.33	19440.69	75%	30586.95	19301.20	63%
Others	7026.39	199.28	3%	7637.79	361.45	5%
Total	451756.11	32821.20	7%	420191.11	34902.17	8%

In the case of Water business, the % receivables to external sales is high whereas the overall ratio for the Group is much lower. In the case of EPC projects undertaken by Water business, the receivables are high as per the norms of the industry and terms of the tender. Majority of projects are executed for the municipalities and before bidding for any contract, the Water business carries out due-diligence to ensure that the customer has made satisfactory funding arrangements. Further, this business group is executing a project on hybrid annuity PPP basis, according to which 40% of EPC value is paid by customer during the construction period and balance 60% will be paid during O&M period of 15 years alongwith interest computed at SBI one year MCLR plus 3%. In the case of Power transmission

Notes to the Consolidated Financial Statements

for the year ended March 31, 2021

(All amounts in ₹ lakhs, unless otherwise stated)

business, the % receivable to external sales is high due to higher year end sales and lower turnover of the business during the year.

Overall, the credit risk from receivable is low in view of diverse businesses and government customers.

(b) Provision for expected credit losses

Basis as explained above, life time expected credit loss ("ECL") is determined on trade receivables except in cases where advance payment terms are prescribed or payment is due from Central / State Government or Government Authorities / entities where there is no track record of short receipts. ECL arising from delays in receiving payments from the Government customers pursuant to sale of goods or under construction contracts are not considered if such delays are commonly prevalent in the industry and / or the delays are not exceeding one year. All other short receipts, other than arising from expense claims, are duly considered in determining ECL. In view of the business model of the Group's engineered-to-order products and the profile of trade receivables, the determination of provision based on age analysis may not be realistic and hence, the provision of expected credit loss is determined for the total trade receivables outstanding as on the reporting date. This provision for ECL is made in addition to the specific credit losses, if any, provided on specific financial assets.

Provision matrix (% , amounts) of ECL for trade receivables (other than specific credit losses separately recognised) is as under:

Business	% ECL	ECL amount as at 31-Mar-21	ECL amount as at 31-Mar-20
Sugar	Nil	Nil	Nil
Distillery	Nil	Nil	Nil
Power transmission	0.84%	36.59	32.90
Water	1.15%	100.40	114.75

(c) Reconciliation of loss allowance provision

Trade receivables:

	Year ended 31-Mar-21	Year ended 31-Mar-20
Balance at beginning of the year	1801.33	1254.92
Additional provisions recognised during the year	445.45	931.04
Provision reversed/utilised during the year	(135.80)	(384.63)
Balance at the end of the year	2110.98	1801.33

Loans and other financial assets:

	Loans		Other financial assets	
	Year ended 31-Mar-21	Year ended 31-Mar-20	Year ended 31-Mar-21	Year ended 31-Mar-20
Balance at beginning of the year	44.53	44.53	15.05	15.05
Movement in expected credit loss allowance during the year	(44.53)	-	-	-
Balance at the end of the year	-	44.53	15.05	15.05

Notes to the Consolidated Financial Statements

for the year ended March 31, 2021

(All amounts in ₹ lakhs, unless otherwise stated)

(ii) Liquidity risk

The Group uses liquidity forecast tools to manage its liquidity. The Group operates capital intensive sugar business and has obligation to timely make cane price payments within the statutory time period. The Group is able to organise liquidity through own funds and through working capital loans. The Group has good relationship with its lenders and has not defaulted at any point of time in the past, as a result of which it does not experience any difficulty in arranging funds from its lenders. However, when the sugar fundamentals are unfavourable, either due to market forces or due to excessive cane pricing by the Government, the payment of cane price gets delayed. However, it is the endeavour of the Group to make cane payment on a priority basis. It is the objective and focus of the Group to reduce debts to be able to meet the cyclicalities of the sugar business.

Apart from cyclical sugar business, the Group has alternate revenue streams in the form of distillery and engineering business, which, to a large extent, offset the impact of sugar cyclicalities.

Table hereunder provides the current ratios of the Group as at the year end:

	As at 31-Mar-21	As at 31-Mar-20
Total current assets	221263.69	265028.78
Total current liabilities	154908.57	210642.44
Current ratio	1.43	1.26

In view of seasonal nature of sugar business, which is a dominant business of the Group, there is a peak build-up of sugar inventories at the year end, resulting in peak working capital requirement. With the liquidation of such inventories over the year, the working capital requirement is gradually reduced. Thus, the current ratio computed at the year end is not a reflection of average and realistic ratio for the year.

(a) Maturities of financial instruments

Maturities of non-derivative financial liabilities:

The following tables detail the remaining contractual maturity for its non-derivative financial liabilities with agreed repayment periods. The amount disclosed in the tables have been drawn up based on the undiscounted cash flows of financial liabilities. The contractual maturity is based on the earliest date on which the Company may be required to pay.

	on demand	< 1 year	1-3 years	3-5 years	> 5 years	Total	Carrying amount
As at 31 March 2021							
Borrowings	56157.43	11540.72	24589.44	4014.31	3187.50	99489.40	97722.10
Trade payables	-	61754.47	675.45	-	-	62429.92	62429.92
Lease liabilities	-	352.85	595.44	373.01	4.23	1325.53	1325.53
Other financial liabilities	-	4735.23	-	-	-	4735.23	4735.23
	56157.43	78383.27	25860.33	4387.32	3191.73	167980.08	166212.78
As at 31 March 2020							
Borrowings	94343.87	15446.73	31439.22	14620.62	-	155850.44	153010.23
Trade payables	-	74902.99	738.92	-	-	75641.91	75641.91
Lease liabilities	-	544.87	575.14	618.11	28.38	1766.50	1766.50
Other financial liabilities	-	5225.42	-	-	-	5225.42	5225.42
	94343.87	96120.01	32753.28	15238.73	28.38	238484.27	235644.06

Notes to the Consolidated Financial Statements

for the year ended March 31, 2021

(All amounts in ₹ lakhs, unless otherwise stated)

Maturities of derivative financial instruments:

The Company enters into derivative contracts (viz. foreign exchange forward contracts) to manage some of its foreign currency exposures that are settled on a net basis. Derivative asset (net) are of ₹ 35.92 lakhs as at 31 March 2021 (31 March 2020 : Derivative liability (net) ₹ 2.19 lakhs), shall mature within one year from reporting date.

(iii) Market risk

The Group is exposed to following key market risks:

- Interest rate risk on loans and borrowings
- Sugar price risk
- Other market risks

(a) Interest rate risk

Most of the borrowings availed by the Group are subject to interest on floating rate basis linked to the MCLR (Marginal Cost of funds based Lending Rate). In view of the fact that the total borrowings of the Group are quite substantial, the Group is exposed to interest rate risk.

The strategy of the Group to opt for floating interest rates is helpful in maintaining market related realistic rates. Further, most of the loans and borrowings have a prepayment clause through which the loans could be prepaid without any prepayment premium. The said clause helps the Group to arrange debt substitution to bring down the interest costs or to prepay the loans out of the surplus funds held. The interest rate risk is largely mitigated as 86% of the long term debts as at 31 March 2021 (31 March 2020 : 99% of long term debts), comprises loans carrying concessional interest rates/interest subvention.

While declining interest rates would be beneficial to the Group, adverse interest rate fluctuations could increase the finance cost. The total impact, in respect of borrowings on floating interest rate basis, is limited as per sensitivity analysis provided here under:

	Year ended 31-Mar-21	Year ended 31-Mar-20
Total debt as at the end of the year	97722.10	153010.23
Debt at floating rate of interest as at the end of the year	76028.93	124478.82
Average availment of borrowings at floating rate of interest	68680.79	127516.81
Impact of 1% interest rate variation	686.81	1275.17

The above sensitivity has been computed after excluding the impact of change in interest rates of the floating interest rate foreign currency borrowing having balance of USD 1,792,114.69 @ 4.833% p.a. (i.e. 6 months LIBOR plus 1.95%) as at 31 March 2019, fully repaid during the previous year, since same had been hedged through interest rate swap @ fixed interest rate 8.5% p.a.

(b) Sugar price risk

The sugar prices are dependent inter-alia on domestic and global sugar balance - higher supplies lead to softening of sugar prices whereas higher demand than available supplies lead to hardening of sugar prices. The Group sells most of its sugar in the domestic market where there are no effective mechanism available to hedge sugar prices in view of limited breadth in the commodity exchanges. The Group also exports sugar in the years of surplus production based on Government policy and incentives being offered.

Notes to the Consolidated Financial Statements

for the year ended March 31, 2021

(All amounts in ₹ lakhs, unless otherwise stated)

Adverse changes in sugar price impact the Group in the following manner:

- The Group values sugar stocks at lower of cost and net realisable value (NRV). In the event, the cost of production of sugar is higher than the NRV, the stocks are written down to NRV leading to recognition of loss on such inventory.
- The Group is a large producer of sugar and even a small variation in the sugar price leads to significant impact on the profitability of the Group.

Sensitivity analysis in respect of sugar price risk is provided here below:

	Year ended 31-Mar-21	Year ended 31-Mar-20
Annual production of sugar (MT)	1007299	971918
Impact of sugar price variation by ₹ 1000/MT	10072.99	9719.18

However, in view of sugar operations being highly efficient, the cost of production is generally lower than the Minimum Sale Prices (MSP) prescribed by the Central Government for sale of sugar and hence, chances of significant losses due to inventory write down are low. Further, in view of floor prices being prescribed by way of MSP, the downside impact on the Group is limited.

(c) Other market risks

The other market risks includes Equity price risk and Foreign currency risk.

Equity price risk in respect of listed and non listed equity securities which are susceptible to market price risk arising from uncertainties about future value of the investment securities. In view of nominal value of investments being held by the Group, other than in associates which are accounted for using equity method, the magnitude of risk is only nominal.

The Group is exposed to foreign currency risk on account of foreign currency loans receivables and foreign exchange trades.

Foreign currency risk exposure

The Group's exposure to foreign currency risk at the end of the reporting period are as follows:

	US\$	EURO	GBP	SGD
As at 31 March 2021				
Financial assets				
- Trade receivables				
	<i>in foreign currency lakhs</i>	3.05	8.08	1.03
	<i>in equivalent ₹ lakhs</i>	221.69	682.91	101.93
- Loans receivables				
	<i>in foreign currency lakhs</i>	25.19	-	-
	<i>in equivalent ₹ lakhs</i>	1831.47	-	-
Derivatives (in respect of underlying financial assets)				
- Foreign exchange forward contracts sell foreign currency				
	<i>in foreign currency lakhs</i>	-	6.04	-
	<i>in equivalent ₹ lakhs</i>	-	510.56	-
Net exposure to foreign currency risk (assets)				
	<i>in foreign currency lakhs</i>	28.24	2.04	1.03
	<i>in equivalent ₹ lakhs</i>	2053.16	172.35	101.93

Notes to the Consolidated Financial Statements

for the year ended March 31, 2021

(All amounts in ₹ lakhs, unless otherwise stated)

		US\$	EURO	GBP	SGD
Financial liabilities					
- Trade payables	in foreign currency lakhs	0.62	1.56	0.07	0.04
	in equivalent ₹ lakhs	46.01	136.36	7.51	2.02
Derivatives (in respect of underlying financial liabilities)					
- Foreign exchange forward contracts buy foreign currency	in foreign currency lakhs	-	-	-	-
	in equivalent ₹ lakhs	-	-	-	-
Net exposure to foreign currency risk (liabilities)	in foreign currency lakhs	0.62	1.56	0.07	0.04
	in equivalent ₹ lakhs	46.01	136.36	7.51	2.02

		US\$	EURO	GBP	SGD
As at 31 March 2020					
Financial assets					
- Trade receivables	in foreign currency lakhs	3.10	0.73	-	-
	in equivalent ₹ lakhs	231.64	60.07	-	-
- Loans receivables	in foreign currency lakhs	4.09	-	-	-
	in equivalent ₹ lakhs	305.50	-	-	-
Derivatives (in respect of underlying financial assets)					
- Foreign exchange forward contracts sell foreign currency	in foreign currency lakhs	4.06	-	-	-
	in equivalent ₹ lakhs	303.40	-	-	-
Net exposure to foreign currency risk (assets)	in foreign currency lakhs	3.13	0.73	-	-
	in equivalent ₹ lakhs	233.74	60.07	-	-
Financial liabilities					
- Trade payables	in foreign currency lakhs	3.59	0.40	0.65	-
	in equivalent ₹ lakhs	273.30	33.92	61.44	-
- Borrowings (including interest)	in foreign currency lakhs	-	-	-	-
	in equivalent ₹ lakhs	-	-	-	-
Derivatives (in respect of underlying financial liabilities)					
- Foreign exchange forward contracts buy foreign currency	in foreign currency lakhs	2.92	-	-	-
	in equivalent ₹ lakhs	222.20	-	-	-
Net exposure to foreign currency risk (liabilities)	in foreign currency lakhs	0.67	0.40	0.65	-
	in equivalent ₹ lakhs	51.10	33.92	61.44	-

Notes to the Consolidated Financial Statements

for the year ended March 31, 2021

(All amounts in ₹ lakhs, unless otherwise stated)

The Group's foreign currency derivatives outstanding (including for firm commitments) at the end of the reporting period are as follows:

		US\$	EURO	GBP	SGD
As at 31 March 2021					
Foreign exchange forward contracts to sell foreign currency	in foreign currency lakhs in equivalent ₹ lakhs	4.06 295.49	12.71 1074.42	- -	- -
Foreign exchange forward contracts to buy foreign currency	in foreign currency lakhs in equivalent ₹ lakhs	- -	- -	- -	- -
As at 31 March 2020					
Foreign exchange forward contracts to sell foreign currency	in foreign currency lakhs in equivalent ₹ lakhs	5.69 425.24	- -	- -	- -
Foreign exchange forward contracts to buy foreign currency	in foreign currency lakhs in equivalent ₹ lakhs	2.92 222.20	2.58 218.47	- -	- -

All the above contracts are maturing within one year from the reporting date.

Sensitivity

The following table demonstrate the sensitivity of net unhedged foreign currency exposures relating to financial instruments to reasonably possible changes in foreign currency exchange rates, with all other variables held constant.

	Change in FC exchange rate by	Impact on profit or loss and equity (in ₹ lakhs)			
		Increase in FC exchange rates		Decrease in FC exchange rates	
		31-Mar-21	31-Mar-20	31-Mar-21	31-Mar-20
US\$ sensitivity	5%	100.36	9.13	(100.36)	(9.13)
EURO sensitivity	5%	1.80	1.31	(1.80)	(1.31)
GBP sensitivity	5%	4.72	(3.07)	(4.72)	3.07
SGD sensitivity	5%	(0.10)	-	0.10	-

Further, the impact of change in foreign currency rates (assuming forward premium to remain unchanged) on the fair valuation of derivatives (excluding derivatives which have hedged the foreign currency denominated receivables and payables) as at the end of the year, is demonstrated in the table below. However, apart from the impact on the profit or loss due to fair value changes of the derivatives, the derivatives will help the Group in capturing the hedged rates including forward premium and the budgeted profitability will remain unaffected.

	Change in FC exchange rate by	Impact on profit or loss and equity (in ₹ lakhs)			
		Increase in FC exchange rates		Decrease in FC exchange rates	
		31-Mar-21	31-Mar-20	31-Mar-21	31-Mar-20
US\$ sensitivity	5%	(14.77)	(6.09)	14.77	6.09
EURO sensitivity	5%	(28.19)	10.92	28.19	(10.92)
GBP sensitivity	5%	-	-	-	-
SGD sensitivity	5%	-	-	-	-

There is no impact on other components of equity since the Group has not elected to apply hedge accounting.

Notes to the Consolidated Financial Statements

for the year ended March 31, 2021

(All amounts in ₹ lakhs, unless otherwise stated)

NOTE 42: FAIR VALUE MEASUREMENTS

(i) Financial instruments by category

	As at 31-Mar-21		As at 31-Mar-20	
	FVTPL *	Amortised cost	FVTPL *	Amortised cost
Financial assets				
Investments				
- Equity instruments	492.13	-	322.77	-
- Bonds	-	165.27	10.67	-
- National Saving Certificates	-	0.03	-	0.03
Trade receivables	-	32821.20	-	34902.17
Loans	-	1846.23	-	339.78
Cash and bank balances	-	1982.48	-	3562.18
Security deposits	-	697.48	-	685.57
Earnest money deposits	-	49.98	-	53.58
Derivative financial assets	35.92	-	-	-
Other receivables	-	148.93	-	94.46
Total financial assets	528.05	37711.60	333.44	39637.77
Financial liabilities				
Borrowings	-	97722.10	-	153010.23
Trade payables	-	62429.92	-	75641.91
Capital creditors	-	1149.76	-	1894.29
Security deposits	-	446.86	-	391.14
Derivative financial liabilities	-	-	2.19	-
Lease liabilities	-	1325.53	-	1766.50
Other payables	-	3138.61	-	2939.99
Total financial liabilities	-	166212.78	2.19	235644.06

*Mandatorily required to be measured at FVTPL. There is no financial instrument which is designated as FVTPL.

(ii) Fair value hierarchy

This section explains the judgements and estimates made in determining the fair values of the financial instruments that are recognised and measured at fair value. To provide an indication about the reliability of the inputs used in determining fair value, the Group has classified its financial instruments into the three levels prescribed under the accounting standard. An explanation of each level follows underneath the table.

Financial assets and liabilities measured at fair value - recurring fair value measurements

	Note No.	Level 1	Level 2	Level 3	Total
As at 31 March 2021					
Financial assets					
- Investments in equity instruments at FVTPL (Quoted)	6	492.13	-	-	492.13
- Foreign exchange forward contract at FVTPL	9	-	35.92	-	35.92
		492.13	35.92	-	528.05

Notes to the Consolidated Financial Statements

for the year ended March 31, 2021

(All amounts in ₹ lakhs, unless otherwise stated)

	Note No.	Level 1	Level 2	Level 3	Total
As at 31 March 2020					
Financial assets					
- Investments in equity instruments at FVTPL (Quoted)	6	322.77	-	-	322.77
- Investments in bonds at FVTPL	6	-	10.67	-	10.67
		322.77	10.67	-	333.44
Financial liabilities					
- Foreign exchange forward contract at FVTPL	17	-	2.19	-	2.19
		-	2.19	-	2.19

Level 1: Level 1 hierarchy includes financial instruments measured using quoted unadjusted market prices in active markets for identical assets or liabilities. This includes listed equity instruments that have quoted price. The fair value of all equity instruments which are traded in the stock exchanges is valued using the closing price as at the reporting date.

Level 2: The fair value of financial instruments that are not traded in an active market is determined using valuation techniques which maximise the use of observable market data and rely as little as possible on entity-specific estimates. If all significant inputs required to fair value an instrument are observable, the instrument is included in level 2.

Level 3: If one or more of the significant inputs is not based on observable market data, the instrument is included in level 3.

There are no transfers between levels 1 and 2 during the year.

(iii) Valuation technique used to determine fair value

Specific valuation techniques used to value financial instruments include:

- the fair value of derivatives (viz. foreign exchange forward contracts) is determined using market observable inputs, including prevalent forward rates for the maturities of the respective contracts and interest rate curves as indicated by banks and third parties.
- the fair value of bonds is determined using observable market data of yield to maturity and coupon rates of securities.

All of the resulting fair value estimates are included in level 2.

(iv) Valuation processes

The Corporate finance team has requisite knowledge and skills in valuation of financial instruments. The team headed by Group CFO directly reports to the audit committee on the fair value of financial instruments.

(v) Fair value of financial assets and liabilities that are not measured at fair value (but fair value disclosures are required)

Except as detailed in the following table, the management considers that the carrying amounts of financial assets and financial liabilities recognised in the financial statements approximate their fair values.

	As at 31-Mar-21		As at 31-Mar-20	
	Carrying amount	Fair value	Carrying amount	Fair value
Financial assets				
Trade receivables	32821.20	32805.26	34902.17	33822.93
	32821.20	32805.26	34902.17	33822.93

Notes to the Consolidated Financial Statements

for the year ended March 31, 2021

(All amounts in ₹ lakhs, unless otherwise stated)

	As at 31-Mar-21		As at 31-Mar-20	
	Carrying amount	Fair value	Carrying amount	Fair value
Financial liabilities				
Trade payables	62429.92	62348.22	75641.91	75550.38
	62429.92	62348.22	75641.91	75550.38

Fair value hierarchy

	Level 1	Level 2	Level 3	Total
As at 31 March 2021				
Financial assets				
Trade receivables	-	-	32805.26	32805.26
	-	-	32805.26	32805.26
Financial liabilities				
Trade payables	-	-	62348.22	62348.22
	-	-	62348.22	62348.22
As at 31 March 2020				
Financial assets				
Trade receivables	-	-	33822.93	33822.93
	-	-	33822.93	33822.93
Financial liabilities				
Trade payables	-	-	75550.38	75550.38
	-	-	75550.38	75550.38

- (a) The fair values for trade receivables and trade payables which are expected to be settled after twelve months (including those which are within the operating cycle) are computed based on discounted cash flows. They are classified as level 3 fair values in the fair value hierarchy due to the inclusion of unobservable inputs including counterparty credit risk. The carrying amounts of the remaining trade receivables and trade payables are considered to be the same as their fair values, due to their short-term nature.

Notes to the Consolidated Financial Statements

for the year ended March 31, 2021

(All amounts in ₹ lakhs, unless otherwise stated)

NOTE 43: GOVERNMENT GRANTS
(i) Government grants recognised in the financial statements

	Grants recognised in profit or loss		Treatment in financial statements	Grant recoverable	
	Year ended 31-Mar-21	Year ended 31-Mar-20		As at 31-Mar-21	As at 31-Mar-20
A Deferred government grants related to income					
a) Loans at below market interest rate aggregating to ₹ 36400 lakhs availed during financial year 2018-19 under the "Scheme for Extending Financial Assistance to Sugar Undertakings 2018" notified by the State Government of Uttar Pradesh.	1125.25	1350.33	Reduced from finance cost (note 30)	-	-
Total deferred government grants	1125.25	1350.33		-	-
B Other revenue government grants					
a) Financial assistance by Government of India under the Scheme for providing assistance to sugar mills for expenses on marketing costs including handling, upgrading and other processing costs and costs of international and internal transport and freight charges on export of sugar during the sugar season 2020-21	545.00	-	Presented under "Other operating revenue" (note 24)	545.00	-
b) Financial assistance by Government of India under the Scheme for providing assistance to sugar mills for expenses on marketing costs including handling, upgrading and other processing costs and costs of international and internal transport and freight charges on export of sugar during the sugar season 2019-20.	17979.14	12967.82	Presented under "Other operating revenue" (note 24)	371.67	12967.82
c) Financial assistance of ₹ 13.88 per quintal of cane crushed during season 2018-19 by the Government of India under the "Scheme for Assistance to Sugar Mills".	-	8344.11	Presented under "Other operating revenue" (note 24)	-	4162.11
	-	2427.02	Reduced from Raw material consumed (note 26)	-	

Notes to the Consolidated Financial Statements

for the year ended March 31, 2021

(All amounts in ₹ lakhs, unless otherwise stated)

	Grants recognised in profit or loss			Grant recoverable	
	Year ended 31-Mar-21	Year ended 31-Mar-20	Treatment in financial statements	As at 31-Mar-21	As at 31-Mar-20
d) Financial assistance by Government of India under the Scheme for defraying expenditure towards internal transport, freight, handling and other charges on export of sugar during the sugar season 2018-19.	-	2072.41	Presented under "Other operating revenue" (note 24)	-	1459.07
	-	1653.17	Reduced from outward freight and forwarding costs under "Other expenses" (note 33)	-	-
e) Financial assistance by Government of India under the Scheme for Creation and Maintenance of Buffer Stock of sugar.	200.64	1224.58	Depicted under "Other income" (note 25)	1897.71	2885.88
	1049.85	2848.01	Reduced from finance cost (note 30)		
f) Interest subvention @ 7% for one year by Government of India on soft loans of ₹ 31000 lakhs availed from banks under the scheme for soft loans to sugar mills	131.37	2044.58	Reduced from finance cost (note 30)	1025.26	1367.97
g) Interest subvention @ 50% of rate charged by lenders (subject to maximum of 6%) by Government of India on loans of ₹ 17693 lakhs availed from banks for distilleries under the "Scheme for extending financial assistance to sugar mills for enhancement and augmentation of ethanol production capacity"	749.33	671.00	Reduced from finance cost (note 30)	696.32	671.00
h) Export incentives under Duty Draw back Scheme, Incremental Export Incentive Scheme and Merchandise Export Incentive Scheme.	54.89	87.77	Presented under "Other operating revenue" (note 24)	35.22	28.73
Total other revenue government grants	20710.22	34340.47		4571.18	23542.58
Total government grants related to income	21835.47	35690.80		4571.18	23542.58

Notes to the Consolidated Financial Statements

for the year ended March 31, 2021

(All amounts in ₹ lakhs, unless otherwise stated)

	Grants received		Treatment in financial statements	Grant recoverable	
	Year ended 31-Mar-21	Year ended 31-Mar-20		As at 31-Mar-21	As at 31-Mar-20
C Government grants related to assets					
a) Grant in respect of Moist Hot Air Treatment Plants (MHAT) and Soil treatment plant received from the State Government of Uttar Pradesh under Rashtriya Krishi Vikas Yojna.	-	7.00	Reduced from gross value of PPE upon receipt. Recognised in profit or loss by way of reduced depreciation (refer note 3 and 31)	-	-
b) Grant in respect of Effluent Treatment Plant from the State Government of Karnataka under Karnataka 2009-14 Industrial Policy.	11.59	-	Reduced from gross value of PPE upon receipt. Recognised in profit or loss by way of reduced depreciation (refer note 3 and 31)	-	-
c) Grant of ₹ 141.45 lakhs in the form of duties saved upon import of machinery during financial year 2017-18 under Export Promotion Capital Goods (EPCG) scheme.	-	-	Reduced from gross value of PPE upon fulfilment of export obligation(s). Recognised in profit or loss by way of reduced depreciation (refer note 3 and 31)	-	-
Total government grants related to assets	11.59	7.00		-	-

Notes to the Consolidated Financial Statements

for the year ended March 31, 2021

(All amounts in ₹ lakhs, unless otherwise stated)

(ii) Movement of deferred government grants is provided here below:

	Year ended 31-Mar-21	Year ended 31-Mar-20
As at the beginning of the year	2946.77	4297.10
Recognised during the year	-	-
Released to the statement of profit and loss	(1125.25)	(1350.33)
As at the end of the year	1821.52	2946.77
Current (refer note 19)	858.92	1125.25
Non-current (refer note 19)	962.60	1821.52
Total	1821.52	2946.77

NOTE 44: INTEREST IN OTHER ENTITIES

(i) Subsidiaries

Details of the Group's subsidiaries at the end of the reporting period are as follows:

Name of Subsidiaries	Principal activities	Place of incorporation and operation	Proportion of ownership interest and voting power held by the Group	
			As at 31-Mar-21	As at 31-Mar-20
Triveni Engineering Limited	see (a) below	India	100%	100%
Triveni Energy Systems Limited	see (a) below	India	100%	100%
Svastida Projects Limited	see (a) below	India	100%	100%
Triveni Entertainment Limited	see (a) below	India	100%	100%
Triveni Industries Limited	see (a) below	India	100%	100%
Triveni Sugar Limited	see (a) below	India	100%	100%
United Shippers & Dredgers Limited	see (a) below	India	100%	0%
Gaurangi Enterprises Limited	see (a) below	India	100%	N.A.
Triveni Foundation (Section 8 company)	Corporate social responsibility activities	India	100%	N.A.
Mathura Wastewater Management Private Limited	Water and wastewater treatment solutions	India	100%	100%

(a) These companies are relatively much smaller and there have been no significant business activities in these companies.

Notes to the Consolidated Financial Statements

for the year ended March 31, 2021

(All amounts in ₹ lakhs, unless otherwise stated)

(ii) Interest in Associates

Details of the Group's associates at the end of the reporting period are as follows:

Name of Associates	Principal activities	Place of incorporation and operation	Proportion of ownership interest and voting power held by the Group	
			As at 31-Mar-21	As at 31-Mar-20
Triveni Turbine Limited	Power generating equipment and solutions	India	21.85%	21.85%
Aqwise Wise Water Technologies Limited	Water and wastewater treatment solutions	Israel	25.04% (refer note 13)	25.04%

The above associates are accounted for using the equity method in these financial statements. Further at the current year end, investment in Aqwise Wise Water Technologies Limited has been classified as "Assets held for sale" (refer note 13).

(a) Summarised financial information of Associates

The summarised financial information below represents amounts based on the associate's financial statements drawn up for consolidation under equity accounting method by the Group.

Summarised balance sheet of Associates

	Triveni Turbine Limited		Aqwise Wise Water Technologies Limited	
	As at 31-Mar-21	As at 31-Mar-20	As at 31-Mar-21*	As at 31-Mar-20*
Current assets	65972.07	53762.02	13632.17	25338.37
Non-current assets	28212.57	28454.44	3214.98	2863.11
Current liabilities	29276.89	27373.42	23042.77	21145.39
Non-current liabilities	1150.04	1825.24	1701.25	6749.24
Contributions of non-controlling interest towards share in losses	-	-	797.58	507.62
Net assets	63757.71	53017.80	(7099.29)	814.47

Summarised statement of profit and loss of Associates

	Triveni Turbine Limited		Aqwise Wise Water Technologies Limited	
	Year ended 31-Mar-21	Year ended 31-Mar-20	Year ended 31-Mar-21*	Year ended 31-Mar-20*
Revenue	70258.31	81786.85	13859.23	22496.18
Profit from continuing operations	10246.27	12177.82	(7532.98)	(2258.51)
Profit from discontinued operations	-	-	-	-
Other comprehensive income	493.63	(683.32)	(69.12)	129.94
Total comprehensive income	10739.90	11494.50	(7602.10)	(2128.57)
Dividend received from the Associate	-	353.14	-	-

Notes to the Consolidated Financial Statements

for the year ended March 31, 2021

(All amounts in ₹ lakhs, unless otherwise stated)

Reconciliation of the above summarised financial information to the carrying amount of the interest in the associates recognised in financial statements:

	Triveni Turbine Limited		Aqwise Wise Water Technologies Limited	
	As at 31-Mar-21	As at 31-Mar-20	As at 31-Mar-21*	As at 31-Mar-20*
Net assets of the Associates	63757.71	53017.80	(7099.29)	814.47
Group's share in %	21.85%	21.85%	25.04%	25.04%
Group's share in ₹	13928.24	11582.05	(1777.66)	203.95
Adjustments:				
Group's share in adjustment for unrealised profits on inter-company transactions (net of tax)	(12.28)	(2.77)	-	-
Goodwill on acquisition (as restated)	(8.11)	(8.11)	2012.75	2057.11
Adjustments in respect of share of capital reserve and security premium earlier considered in the carrying amount of investment, consequent to divestment (refer note 13)	-	-	123.10	-
Other adjustments	0.07	0.07	-	-
Transferred to "Assets held for sale" (refer note 13)	-	-	(358.19)	-
Carrying amount	13907.92	11571.24	-	2261.06

*The consolidation of accounts of Aqwise Wise Water Technologies Limited., under equity accounting method, is done using its most recent available financial statements for the year ended 31 December 2020/2019 adjusted for the effects of significant transactions / events for the quarter ended 31 March 2021/2020, if any (refer note 13).

NOTE 45: ADDITIONAL INFORMATION REQUIRED BY SCHEDULE III

Name of the entity in the Group	Net Assets, i.e., total assets minus total liabilities		Share in profit or loss		Share in other comprehensive income		Share in total comprehensive income	
	As % of consolidated net assets	Amount	As % of consolidated profit or loss	Amount	As % of consolidated other comprehensive income	Amount	As % of consolidated total comprehensive income	Amount
Parent								
Triveni Engineering & Industries Limited								
31 March 2021	86.35%	134326.92	97.56%	28740.69	47.52%	(28.86)	97.66%	28711.83
31 March 2020	86.31%	115540.78	91.67%	30718.64	158.36%	(96.19)	92.15%	30622.45
Subsidiaries (Group's share)								
Indian								
Triveni Engineering Limited								
31 March 2021	0.07%	110.13	0.00%	(0.98)	0.00%	-	0.00%	(0.98)
31 March 2020	0.09%	118.55	0.00%	(0.93)	0.00%	-	0.00%	(0.93)

Notes to the Consolidated Financial Statements

for the year ended March 31, 2021

(All amounts in ₹ lakhs, unless otherwise stated)

Name of the entity in the Group	Net Assets, i.e., total assets minus total liabilities		Share in profit or loss		Share in other comprehensive income		Share in total comprehensive income	
	As % of consolidated net assets	Amount	As % of consolidated profit or loss	Amount	As % of consolidated other comprehensive income	Amount	As % of consolidated total comprehensive income	Amount
Triveni Energy Systems Limited								
31 March 2021	0.08%	118.62	0.00%	(0.95)	0.00%	-	0.00%	(0.95)
31 March 2020	0.09%	118.04	0.00%	(0.92)	0.00%	-	0.00%	(0.92)
Triveni Sugar Limited								
31 March 2021	0.07%	106.62	0.00%	(1.05)	0.00%	-	0.00%	(1.05)
31 March 2020	0.08%	110.26	-0.01%	(4.28)	0.00%	-	-0.01%	(4.28)
Svastida Projects Limited								
31 March 2021	0.09%	133.80	0.00%	(0.92)	0.00%	-	0.00%	(0.92)
31 March 2020	0.10%	134.71	0.00%	(1.49)	0.00%	-	0.00%	(1.49)
Triveni Entertainment Limited								
31 March 2021	0.08%	128.07	0.00%	(1.46)	0.00%	-	0.00%	(1.46)
31 March 2020	0.09%	122.55	0.00%	(1.24)	0.00%	-	0.00%	(1.24)
Triveni Industries Limited								
31 March 2021	0.07%	104.45	0.00%	(1.23)	0.00%	-	0.00%	(1.23)
31 March 2020	0.08%	111.60	-0.02%	(4.86)	0.00%	-	-0.02%	(4.86)
Mathura Wastewater Management Private Limited								
31 March 2021	4.64%	7211.54	2.07%	608.97	0.00%	-	2.07%	608.97
31 March 2020	5.60%	7490.59	2.29%	768.29	0.00%	-	2.31%	768.29
Gaurangi Enterprises Limited								
31 March 2021	0.08%	126.50	-0.01%	(3.72)	0.00%	-	-0.01%	(3.72)
31 March 2020	0.00%	-	0.00%	-	0.00%	-	0.00%	-
United Shippers & Dredgers Limited								
31 March 2021	0.00%	(0.82)	0.00%	(0.12)	0.00%	-	0.00%	(0.12)
31 March 2020	0.00%	-	0.00%	-	0.00%	-	0.00%	-
Associates (Investments as per the equity method)								
Indian								
Triveni Turbine Limited								
31 March 2021	8.49%	13201.57	7.57%	2228.85	-177.53%	107.84	7.94%	2336.69
31 March 2020	8.12%	10864.89	7.77%	2604.14	47.19%	(133.24)	7.44%	2470.90
Foreign								
Aqwise Wise Water Technologies Limited								
31 March 2021	0.00%	-	-7.15%	(2107.81)	230.02%	(139.72)	-7.64%	(2247.53)
31 March 2020	-0.56%	(745.13)	-1.69%	(565.53)	18.74%	(52.92)	-1.86%	(618.45)
Total								
31 March 2021	100.00%	155567.40	100.00%	29460.27	100.00%	(60.74)	100.00%	29399.53
31 March 2020	100.00%	133866.84	100.00%	33511.82	100.00%	(282.35)	100.00%	33229.47

Notes to the Consolidated Financial Statements

for the year ended March 31, 2021

(All amounts in ₹ lakhs, unless otherwise stated)

NOTE 46: LEASES

As Lessee

The Group had acquired a land with original lease term of ninety years and had paid one-time payment of lease charges (i.e. the market value of the land) in respect of this lease at the inception of lease. There are no further future lease maintenance payments, no contingent rent or restriction imposed under the lease agreement and the Group has transfer rights in respect of such land. In terms of criteria specified in Ind AS 116 Leases, such lease has been recognised as Right-of-use assets during the current year (refer note 3).

Apart from above mentioned lease, assets taken under lease mainly includes various residential, office, godown premises and plots of land. These are generally not non-cancellable leases (except for few premises) having unexpired period upto ten years. The leases are renewable by mutual consent and on mutually agreeable terms. The Group has given refundable interest free security deposits under certain lease agreements. There is no contingent rent, sublease payments or restriction imposed in the lease agreement. In terms of criteria specified in AS 116 Leases, for some of these leases (i.e. leases other than with short term period or low value assets), present value of all future lease payments has been recognised as Right-of-use assets and lease liabilities with the charge for depreciation on Right-of-use assets and interest on lease liabilities in the statement of profit and loss (refer note 3 & 30) and for other leases, yearly lease payments has been expensed off on straight line basis over lease term as rent expenses (refer note 33).

Amounts recognised as expense

	Year ended 31-Mar-21	Year ended 31-Mar-20
Depreciation expense - Right-of-use assets (Land) (refer note 3)	5.69	5.40
Depreciation expense - Right-of-use assets (Building) (refer note 3)	552.39	626.64
Interest on lease liabilities (refer note 30)	147.12	185.93
Rent expense - short term leases (refer note 33)	196.34	165.27
Total	901.54	983.24

Total cash outflow for leases during the year ended 31 March 2021 is ₹ 911.97 lakhs (31 March 2020: ₹ 810.42 lakhs).

Commitments for short term leases as at 31 March 2021 is ₹ 57.91 lakhs (31 March 2020: ₹ 26.39 lakhs).

Group's share of associates' commitments for short term leases as at 31 March 2021 is Nil (31 March 2020: ₹ 28.33 lakhs).

As Lessor

The Group has given certain portion of its office / factory premises under operating leases [including lease of investment property (refer note 4)]. These leases are not non-cancellable and are extendable by mutual consent and at mutually agreeable terms. The gross carrying amount, accumulated depreciation and depreciation recognised in the statement of profit and loss in respect of such portion of the leased premises are not separately identifiable. There is no impairment loss in respect of such premises. No contingent rent has been recognised in the statement of profit and loss. There are no minimum future lease payments as there are no non-cancellable leases. Lease income is recognised in the statement of profit and loss under "Other income" (refer note 25). Lease income earned by the Group from its investment properties and direct operating expenses arising on the investment properties for the year is set out in note 4.

Notes to the Consolidated Financial Statements

for the year ended March 31, 2021

(All amounts in ₹ lakhs, unless otherwise stated)

NOTE 47: COMMITMENTS

	As at 31-Mar-21	As at 31-Mar-20
(i) Estimated amount of contracts remaining to be executed on capital account and not provided for (net of advances)	9530.44	733.11
(ii) Group's share of associates' commitments:		
Estimated amount of contracts remaining to be executed on capital account and not provided for (net of advances)	30.86	159.83

NOTE 48: CONTINGENT LIABILITIES AND CONTINGENT ASSETS

Contingent liabilities

	As at 31-Mar-21	As at 31-Mar-20																																		
Claims against the Group not acknowledged as debts:																																				
i) Claims which are being contested by the Group and in respect of which the Group has paid amounts aggregating to ₹ 439.01 lakhs (31 March 2020: ₹ 407.89 lakhs), excluding interest, under protest pending final adjudication of the cases:	7852.59	7625.34																																		
<table border="1"> <thead> <tr> <th rowspan="2">Sl. No.</th> <th rowspan="2">Particulars</th> <th colspan="2">Amount of contingent liability</th> <th colspan="2">Amount paid</th> </tr> <tr> <th style="text-align: right;">31-Mar-21</th> <th style="text-align: right;">31-Mar-20</th> <th style="text-align: right;">31-Mar-21</th> <th style="text-align: right;">31-Mar-20</th> </tr> </thead> <tbody> <tr> <td>1</td> <td>Sales tax</td> <td style="text-align: right;">531.51</td> <td style="text-align: right;">328.98</td> <td style="text-align: right;">95.91</td> <td style="text-align: right;">65.35</td> </tr> <tr> <td>2</td> <td>Excise duty</td> <td style="text-align: right;">312.73</td> <td style="text-align: right;">287.73</td> <td style="text-align: right;">275.74</td> <td style="text-align: right;">273.86</td> </tr> <tr> <td>3</td> <td>GST</td> <td style="text-align: center;">-</td> <td style="text-align: right;">0.59</td> <td style="text-align: center;">-</td> <td style="text-align: right;">0.59</td> </tr> <tr> <td>4</td> <td>Others*</td> <td style="text-align: right;">7008.35</td> <td style="text-align: right;">7008.04</td> <td style="text-align: right;">67.36</td> <td style="text-align: right;">68.09</td> </tr> </tbody> </table>	Sl. No.	Particulars	Amount of contingent liability		Amount paid		31-Mar-21	31-Mar-20	31-Mar-21	31-Mar-20	1	Sales tax	531.51	328.98	95.91	65.35	2	Excise duty	312.73	287.73	275.74	273.86	3	GST	-	0.59	-	0.59	4	Others*	7008.35	7008.04	67.36	68.09		
Sl. No.			Particulars	Amount of contingent liability		Amount paid																														
	31-Mar-21	31-Mar-20		31-Mar-21	31-Mar-20																															
1	Sales tax	531.51	328.98	95.91	65.35																															
2	Excise duty	312.73	287.73	275.74	273.86																															
3	GST	-	0.59	-	0.59																															
4	Others*	7008.35	7008.04	67.36	68.09																															
*Amount of contingent liability includes ₹ 5973.50 lakhs as at 31 March 2021 (31 March 2020 : ₹ 5973.50 lakhs) in respect of interest on delayed payment of cane price for the sugar seasons 2012-13, 2013-14 and 2014-15 in respect of which the Hon'ble Allahabad High Court had passed an order directing the Cane Commissioner of the State to decide the matter afresh, taking into consideration certain additional factors. The Cane Commissioner is understood to have filed an affidavit in a contempt proceeding, specifying interest rates on delayed cane price payments but no such order of the Cane Commissioner has been served on the Company or industry association and such order, which if served may be legally challenged.																																				
(ii) The Group is contingently liable in respect of short provision against disputed income tax liabilities (excluding determination of final interest payable thereon) of ₹ 3065.18 lakhs (31 March 2020: ₹ 3186.95 lakhs) against which ₹ 1666.79 lakhs (31 March 2020: ₹ 1718.94 lakhs) stands paid. The disputed income tax liability mainly arises on the issue of taxability of unrealised incentives, majority of which have been held to be non-taxable in the first appeal filed by the Group against which the Department has filed appeals before the Tribunal.	3065.18	3186.95																																		

Notes to the Consolidated Financial Statements

for the year ended March 31, 2021

(All amounts in ₹ lakhs, unless otherwise stated)

	As at 31-Mar-21	As at 31-Mar-20
(iii) Liability arising from claims / counter claims/ interest in arbitration/ court cases, claims of certain employees/ex-employees and in respect of service tax, if any, on certain activities of the Group which are being contested by the Group.	Indeterminate	Indeterminate
(iv) Group's share of associates' contingent liabilities	174.60	159.53

The amount shown above represent the best possible estimates arrived at on the basis of available information. The uncertainties, possible payments and reimbursements are dependent on the outcome of the different legal processes which have been invoked by the Group or the claimants, as the case may be, and therefore cannot be predicted accurately. The Group engages reputed professional advisors to protect its interests and has been advised that it has strong legal position against such disputes.

Contingent assets

Based on management analysis, there are no material contingent assets as at 31 March 2021 and as at 31 March 2020.

NOTE 49: DISCLOSURES OF MICRO ENTERPRISES AND SMALL ENTERPRISES

Based on the intimation received by the Group from its suppliers regarding their status under the Micro, Small and Medium Enterprises Development Act, 2006, the relevant information is provided here below:

	31-Mar-21	31-Mar-20
The principal amount and the interest due thereon remaining unpaid to any supplier at the end of each accounting year; as at the end of the year		
(i) Principal amount (refer note 17 & 21)	563.31	6.73
(ii) Interest due on above	-	-
The amount of interest paid by the buyer in terms of section 16 of Micro, Small and Medium Enterprises Development Act, 2006 (27 of 2006), along with the amount of the payment made to the supplier beyond the appointed day during each accounting year.	-	-
The amount of interest due and payable for the period of delay in making payment (which has been paid but beyond the appointed day during the year) but without adding the interest specified under the Micro, Small and Medium Enterprises Development Act, 2006	-	-
The amount of interest accrued and remaining unpaid at the end of each accounting year; and	-	-
The amount of further interest remaining due and payable even in the succeeding years, until such date when the interest dues above are actually paid to the small enterprise, for the purpose of disallowance of a deductible expenditure under section 23 of the Micro, Small and Medium Enterprises Development Act, 2006	-	-

Notes to the Consolidated Financial Statements

for the year ended March 31, 2021

(All amounts in ₹ lakhs, unless otherwise stated)

NOTE 50: COMPARATIVES

The Group has reclassified certain items of financials of comparative year to conform to this year's classification, however, impact of these reclassification are not material.

NOTE 51: APPROVAL OF CONSOLIDATED FINANCIAL STATEMENTS

The consolidated financial statements were approved for issue by the Board of Directors of the Company on 29 June 2021 subject to approval of shareholders.

As per our report of even date attached

For S S Kothari Mehta & Company
Chartered Accountants

Firm's registration number : 000756N

Yogesh K. Gupta

Partner

Membership No. 093214

Date : June 29, 2021

For and on behalf of the Board of Directors of Triveni Engineering & Industries Limited

Dhruv M. Sawhney

Chairman & Managing Director

Suresh Taneja

Group CFO

Homai A. Daruwalla

Director & Chairperson Audit Committee

Geeta Bhalla

Group Vice President & Company Secretary

INFORMATION ON COMPANY'S BUSINESS LOCATIONS

Registered Office

Deoband, District-Saharanpur
Uttar Pradesh-247 554
STD Code: 01336
Phone: 222185, 222866
9759608000, 9759607000
CIN- L15421UP1932PLC022174

Corporate Office

'Express Trade Towers', 8th Floor
15-16, Sector-16A
Noida - 201 301(U.P.)
STD Code: 0120
Phone: 4308000
Fax: 4311010-11

Share Department/Investors' Grievances

'Express Trade Towers', 8th Floor
15-16, Sector-16A
Noida - 201 301 (U.P.)
STD Code: 0120
Phone: 4308000
Fax: 4311010-11
Email: shares@trivenigroup.com

Registrar and Share Transfer Agents

For Equity shares held in physical and electronic mode (Correspondence Address)
M/s KFin Technologies Pvt. Ltd.,
Unit: Triveni Engineering & Industries Limited
Selenium Tower B,
Plot 31-32, Gachibowli,
Financial District, Nanakramguda,
Hyderabad-500 032.
Tel. 040-67162222,
Fax 040-23001153
Email: einward.ris@kfintech.com

Khatauli Sugar Unit

Khatauli, District- Muzaffarnagar,
Uttar Pradesh-251 201
STD Code: 01396
Phone: 08859108061/062/063

Deoband Sugar Unit

Deoband, District-Saharanpur
Uttar Pradesh-247 554
STD Code: 01336
Phone: 222185, 222866

Ramkola Sugar Unit

Ramkola, District-Kushinagar
Uttar Pradesh-274 305
STD Code: 05567
Phone: 9936300473
Fax: 2562483

Sabitgarh Sugar Unit

P.O. Karora, Tehsil Khurja
District - Bulandshahar,
Uttar Pradesh-203 129
STD Code: 05733
Phone: 9557794246/247

Rani Nangal Sugar Unit

Rani Nangal, Tehsil
Thakurdwara
District - Moradabad
Uttar Pradesh-244 401
STD Code: 0591
Phone: 09690003373

Milak Narayanpur Sugar Unit

Milak Narayanpur, P.O. Dadiyal
District-Rampur
Uttar Pradesh-244 925
STD Code: 0595
Phone: 09758400160
Fax: 2565002

Chandanpur Sugar Unit

P.O. Chapna, Tehsil-Hasanpur,
District- Amroha
Uttar Pradesh-244 255
STD Code: 05924
Phone: 267004/05, 7830220828
Fax: 267001

Co-generation Khatauli

Khatauli, District- Muzaffarnagar,
Uttar Pradesh-251 201
STD Code: 01396
Phone: 08859108061/62/63

Co-generation Deoband

Deoband, District-Saharanpur
Uttar Pradesh-247 554
STD Code: 01336
Phone: 222185, 222866

Alco-Chemical

Unit - Muzaffarnagar*

Village Bhikki Bilaspur,
Jolly Road,
District - Muzaffarnagar,
Uttar Pradesh-251 001
STD Code: 0131

Distillery Unit - Sabitgarh

P.O. Karora, Tehsil Khurja
District-Bulandshahar,
Uttar Pradesh-203 129

Branded Division

'Express Trade Towers',
8th Floor
15-16, Sector-16A
Noida 201 301 (U.P.)
STD Code: 0120
Phone: 4308000
Fax: 4311010-11

Power Transmission Business

1,2,3 Belagola Industrial Area,
Metagalli Post, K.R.S. Road,
Mysore-570 016
STD Code: 0821
Phone: 4286501, 4286502
Fax: 4286531

Water Business

Plot No.44, Block-A,
Phase II Extension,
Hosiery Complex,
Noida-201 305,
District Gautam Budh
Nagar, U.P.
STD Code: 0120
Phone: 4748000
Fax: 4243049

Subsidiary Companies

Triveni Industries Limited
Triveni Engineering Limited
Triveni Energy Systems Limited
Triveni Entertainment Limited
Triveni Sugar Limited
Svastida Projects Limited
Mathura Wastewater
Management Private Limited
Gaurangi Enterprises Limited
United Shippers &
Dredgers Limited
Triveni Foundation
(Section 8 Company)

Corporate Information

Chairman and Managing Director

Mr. Dhruv M. Sawhney
(DIN-00102999)

Vice Chairman & Managing Director

Mr. Tarun Sawhney
(DIN-00382878)

Directors

Mr. Nikhil Sawhney
(DIN-00029028)

Mr. Shekhar Datta¹
(DIN-00045591)

Ms. Homai A. Daruwalla
(DIN-00365880)

Dr. Santosh Pande
(DIN-01070414)

Mr. Sudipto Sarkar
(DIN-00048279)

Mr. Jitendra Kumar Dadoo
(DIN-02481702)

Mr. Ajay Kumar Relan²
(DIN:00002632)

Group Chief Financial Officer Mr. Suresh Taneja

Group Vice President & Company Secretary Ms. Geeta Bhalla

Bankers

Punjab National Bank
Central Bank of India
State Bank of India
Axis Bank Ltd.
RBL Bank Ltd.
Yes Bank Ltd
Canara Bank
IDBI Bank Ltd.
IndusInd Bank Ltd.
ICICI Bank Ltd.
HDFC Ltd.

Auditors

M/s S.S. Kothari Mehta &
Company

Triveni Group website
www.trivenigroup.com

*IMIL & Hand Sanitizer are also manufactured here

¹Ceased to be a director w.e.f. close of board meeting on June 29, 2021

²Inducted w.e.f. June 29, 2021



CIN-L15421UP1932PLC022174

8th Floor, Express Trade Towers, Plot No. 15 & 16,
Sector 16-A, Noida-201 301, Uttar Pradesh

www.trivenigroup.com